



National
Defence

A-DH-201-000/PT-000

THE CANADIAN ARMED FORCES MANUAL OF DRILL AND CEREMONIAL

(BILINGUAL)

(Supersedes A-PD-201-000/PT-000 dated 2006-11-17)

**Issued on Authority of the Chief of the Defence Staff
Publiée avec l'autorisation du Chef d'état-major de la Défense**

OPI: DHH

2014-06-15

LIST OF EFFECTIVE PAGES

Insert latest changed pages and dispose of superseded pages in accordance with applicable orders.

NOTE

The portion of the text affected by the latest change is indicated by a black vertical line in the margin of the page. Changes to illustrations are indicated by miniature pointing hands or black vertical lines.

Dates of issue for original and changed pages are:

Original.....	0	2013-05-15
Ch/Mod.....	1	
Ch/Mod.....	2	

Zero in Change No. column indicates an original page. The use of the letter E or F indicates the change is in English or French only. Total number of pages in this publication is 684 consisting of the following:

Contact Officer: DHH 3

© 2001 DND/MDN Canada

FOREWORD

1. A-DH-201-000/PT-000, Canadian Armed Forces Manual of Drill and Ceremonial, is issued on authority of the Chief of the Defence Staff.
2. This publication is effective on receipt, and supersedes:
 - a. the edition of 15 June 2006 ; and
 - b. corresponding Canadian Forces Administrative Orders dealing with military honours and gun salutes. These will be cancelled by a separate message once distribution of this manual is complete.
3. Suggestions for changes shall be forwarded through normal channels to National Defence Headquarters, Attention – Director History and Heritage.

TABLE OF CONTENTS

CHAPTER 1 INTRODUCTION	1-1-1
SECTION 1 GENERAL	1-1-1
PURPOSE	1-1-1
AIM	1-1-1
ORIGINS	1-1-1
TERMINOLOGY	1-1-1
GENERAL	1-1-2
DRILL AND PROCEDURE	1-1-2
DRILL STANDARDS	1-1-2
SYMBOLS	1-1-2
INSTRUCTION TECHNIQUES	1-1-4
CONDUCT OF A DRILL LESSON	1-1-4
WORDS OF COMMAND	1-1-5
STANDARD PAUSE	1-1-6
MECHANICAL TRAINING AIDS	1-1-7
INSPECTION	1-1-7
FUNDAMENTALS OF FOOT DRILL	1-1-7
BASIC SKILLS	1-1-8
SECTION 2 COMPLIMENTS	1-2-1
GENERAL	1-2-1
FORMED MILITARY GROUPS	1-2-1
INDIVIDUAL	1-2-2
CIVILIAN DRESS	1-2-2
SPECIAL CIRCUMSTANCES	1-2-2
MILITARY HONOURS AND GUN SALUTES	1-2-6
COMMISSIONED WARSHIPS AND BOATS	1-2-6
ANNEX A DEFINITIONS	1A
CHAPTER 2 SQUAD DRILL AT THE HALT WITHOUT ARMS	2-1
FORMATION OF A SQUAD	2-1
POSITION OF ATTENTION	2-2
POSITION OF STAND AT EASE	2-3
STAND AT EASE FROM ATTENTION	2-3
STAND EASY	2-4
STAND AT EASE FROM STAND EASY	2-4
ATTENTION FROM STAND AT EASE	2-4
CARRYING OF ARTICLES	2-5
REMOVE HEADDRESS	2-6
STAND AT EASE WITH HEADDRESS REMOVED	2-7
STAND EASY WITH HEADDRESS REMOVED	2-7
REPLACE HEADDRESS	2-7
SALUTING, AT THE HALT, WITHOUT ARMS	2-8
TURNING AND INCLINING AT THE HALT	2-9
CLOSING TO THE RIGHT (LEFT)	2-10
CALLING THE ROLL	2-11
NUMBERING	2-11
PROVING	2-12

PACES FORWARD AND TO THE REAR	2-12
DRESSING A SQUAD	2-13
OPEN ORDER MARCH	2-14
CLOSE ORDER MARCH	2-15
ORDERING A SQUAD ON PARADE	2-15
DISMISSING A SQUAD	2-16
FALLING OUT OF RANKS	2-17
FALLING INDIVIDUALS IN	2-18
SIZING IN THREE RANKS	2-18
SIZING IN TWO RANKS AND REFORMING THREES	2-19
SIZING IN SINGLE RANK AND REFORMING THREES	2-20
FORMING TWO RANKS FROM THREE	2-20
REFORMING THREE RANKS FROM TWO	2-21
FORMING FOUR OR MORE RANKS	2-21

CHAPTER 3 SQUAD DRILL ON THE MARCH WITHOUT ARMS	3-1
FUNDAMENTALS	3-1
PACE LENGTH AND CADENCES	3-1
WORDS OF COMMAND	3-2
MARCHING AND HALTING IN QUICK TIME	3-5
MARCHING AND HALTING IN DOUBLE TIME	3-7
MARCHING AND HALTING IN SLOW TIME	3-8
STEPPING OUT AND STEPPING SHORT	3-9
MARK TIME, FORWARD AND HALT IN SLOW TIME	3-10
MARK TIME, FORWARD AND HALT IN QUICK TIME	3-11
WHEELS	3-12
CHANGE STEP ON THE MARCH	3-15
CHANGE STEP WHEN MARKING TIME	3-16
FORM HOLLOW SQUARE	3-16
SALUTE ON THE MARCH WITHOUT ARMS	3-18
PAYING UNIT COMPLIMENTS WITH A SQUAD ON THE MARCH	3-19
URNS AND INCLINES ON THE MARCH IN SLOW TIME	3-20
URNS AND INCLINES ON THE MARCH IN QUICK TIME	3-22
ABOUT TURN ON THE MARCH IN SLOW TIME	3-24
ABOUT TURN ON THE MARCH IN QUICK TIME	3-25
CHANGE TO QUICK TIME FROM SLOW TIME	3-26
CHANGE TO DOUBLE TIME FROM QUICK TIME	3-26
CHANGE TO QUICK TIME FROM DOUBLE TIME	3-26
CHANGE TO SLOW TIME FROM QUICK TIME	3-26
CHANGE DIRECTION BY FORMING FROM THE HALT	3-27
CHANGE DIRECTION BY FORMING ON THE MARCH	3-29
FORM SQUAD IN LINE FROM THE HALT	3-29
FORM SQUAD IN LINE ON THE MARCH	3-30
SQUAD IN THREES FORMING SINGLE FILE FROM THE HALT	3-32
SQUAD IN THREES FORMING SINGLE FILE ON THE MARCH	3-32
SQUAD IN SINGLE FILE REFORMING THREES FROM THE HALT	3-32
SQUAD IN SINGLE FILE REFORMING THREES ON THE MARCH	3-33
SQUAD IN LINE FORMING SINGLE FILE FROM THE HALT	3-33
SQUAD IN LINE FORMING SINGLE FILE ON THE MARCH	3-33
SQUAD IN SINGLE FILE REFORMING LINE FROM THE HALT	3-34
SQUAD IN SINGLE FILE REFORMING LINE ON THE MARCH	3-34
OPEN ORDER ON THE MARCH IN SLOW TIME	3-34

CLOSE ORDER ON THE MARCH IN SLOW TIME	3-35
CHAPTER 4 C7 RIFLE DRILL	4-1-1
SECTION 1 BASIC RIFLE DRILL	1-1-1
INTRODUCTION	4-1-1
C7A2 RIFLE	4-1-2
ATTENTION	4-1-3
STAND AT EASE FROM ATTENTION	4-1-4
STAND EASY FROM STAND AT EASE	4-1-5
STAND AT EASE FROM STAND EASY	4-1-5
ATTENTION FROM STAND AT EASE	4-1-5
SHORT TRAIL ARMS	4-1-6
GROUND ARMS	4-1-7
TAKE UP ARMS	4-1-8
SHOULDER ARMS FROM THE ORDER	4-1-8
ORDER ARMS FROM THE SHOULDER	4-1-9
DRESSING A SQUAD	4-1-10
ORDERING A SQUAD WITH RIFLES ON PARADE	4-1-10
PRESENT ARMS FROM THE SHOULDER	4-1-11
SHOULDER ARMS FROM THE PRESENT	4-1-12
FIX BAYONETS	4-1-13
UNFIX BAYONETS	4-1-15
EXAMINE ARMS FROM THE ORDER	4-1-17
EASE SPRINGS	4-1-18
ORDER ARMS FROM THE EXAMINE	4-1-20
SHOULDER ARMS FROM THE EXAMINE	4-1-20
SALUTE AT THE SHOULDER	4-1-21
PORT ARMS FROM THE ORDER	4-1-22
ORDER ARMS FROM THE PORT	4-1-23
PORT ARMS FROM THE SHOULDER	4-1-24
SHOULDER ARMS FROM THE PORT	4-1-25
TRAIL ARMS FROM THE SHOULDER	4-1-26
SHOULDER ARMS FROM THE TRAIL	4-1-27
CHANGE ARMS AT THE TRAIL	4-1-28
CHANGE ARMS AT THE SHOULDER	4-1-29
OTHER POSITIONS FOR CARRYING THE RIFLE	4-1-30
SECTION 2	4-2-1
CEREMONIAL RIFLE DRILL	4-2-1
RECOVER ARMS FROM THE SHOULDER	4-2-1
SHOULDER ARMS FROM THE RECOVER	4-2-2
REST ON YOUR ARMS REVERSED FROM THE PRESENT	4-2-2
PRESENT ARMS FROM REST ON YOUR ARMS REVERSED	4-2-3
FIRING CARTRIDGES FROM THE ORDER	4-2-4
FIRING VOLLEYS – MILITARY FUNERALS	4-2-6
REVERSE ARMS FROM THE SHOULDER	4-2-7
SHOULDER ARMS FROM THE REVERSE	4-2-8
CHANGE ARMS AT THE REVERSE	4-2-8
CHAPTER 5 C8 CARBINE DRILL	5-1-1

SECTION 1 BASIC CARBINE DRILL	5-1-1
INTRODUCTION	5-1-1
SHOULDER ARMS (POSITION OF ATTENTION)	5-1-1
STAND AT EASE FROM ATTENTION	5-1-2
STAND EASY FROM THE STAND AT EASE	5-1-2
STAND AT EASE FROM THE STAND EASY	5-1-2
ATTENTION FROM STAND AT EASE	5-1-2
C8 CARBINE	5-1-3
GROUND ARMS FROM THE SHOULDER	5-1-4
TAKE UP ARMS	5-1-4
DRESSING A SQUAD	5-1-5
ORDERING A SQUAD WITH CARBINES ON PARADE	5-1-5
FIX BAYONETS	5-1-5
UNFIX BAYONETS	5-1-7
EXAMINE ARMS FROM THE SHOULDER	5-1-9
EASE SPRINGS	5-1-10
SHOULDER ARMS FROM THE EXAMINE	5-1-11
SHOULDER ARMS FROM THE PORT	5-1-12
SECTION 2 CEREMONIAL CARBINE DRILL	5-2-1
FIRING CARTRIDGES FROM THE SHOULDER	5-2-1
FIRING VOLLEYS – MILITARY FUNERALS	5-2-1
REVERSE ARMS FROM THE SHOULDER	5-2-1
CHANGE ARMS AT THE REVERSE	5-2-1
CHAPTER 6 SWORD, PACE STICK AND CANE DRILL	6-1-2
SECTION 1 SWORD DRILL	6-1-2
GENERAL	6-1-2
POSITION OF ATTENTION	6-1-5
THE CARRY	6-1-5
THE RECOVER	6-1-6
STAND AT EASE	6-1-6
STAND EASY	6-1-7
ATTENTION FROM STAND AT EASE	6-1-7
DRAW SWORDS	6-1-8
RETURN SWORD FROM THE CARRY	6-1-9
MARCHING WITH SWORD IN/OUT OF SCABBARD	6-1-11
HALT	6-1-11
SALUTING AT THE HALT	6-1-12
SALUTING ON THE MARCH IN SLOW TIME	6-1-13
SALUTING ON THE MARCH IN QUICK TIME	6-1-14
FORMING WEDDING ARCH	6-1-15
FORMING ARCH FROM THE CARRY	6-1-15
CARRY FROM THE ARCH	6-1-16
REST ON YOUR ARMS REVERSED FROM THE SALUTE	6-1-16
SALUTE FROM REST ON YOUR ARMS REVERSED	6-1-17
FUNERAL PROCESSIONS	6-1-17
POSITION WHEN SEATED	6-1-19
SECTION 2 PACE STICK AND CANE DRILL	6-2-20

THE PACE STICK	6-2-20
THE CANE	6-2-20
DRILL ON THE MARCH	6-2-20
CLOSED: ATTENTION OR CARRY POSITION	6-2-21
CLOSED: STAND AT EASE	6-2-22
CLOSED: STAND EASY	6-2-22
CLOSED: ATTENTION AT THE SHOULDER	6-2-22
CLOSED: STAND AT EASE AT THE SHOULDER	6-2-23
CLOSED: STAND EASY AT THE SHOULDER	6-2-23
CLOSED: TRAIL FROM THE CARRY AT THE HALT	6-2-23
CLOSED: TRAIL FROM THE CARRY ON THE MARCH	6-2-24
CLOSED: CARRY FROM THE TRAIL AT THE HALT	6-2-24
CLOSED: CARRY FROM THE TRAIL ON THE MARCH	6-2-25
FIGURE 6-2-5 TRAIL FROM THE CARRY POSITION ON THE MARCH	6-2-25
CLOSED: HALTING	6-2-26
CLOSED: SALUTING	6-2-26
OPEN: ATTENTION	6-2-27
OPEN: STAND AT EASE	6-2-28
OPEN: STAND EASY	6-2-28
OPEN: MARCHING AND HALTING NOT PACING	6-2-29
OPEN: PACING	6-2-30
OPEN: SALUTING	6-2-31

CHAPTER 7 PLATOON, COMPANY AND BATTALION DRILL **7-1-1**

SECTION 1 INTRODUCTION **7-1-1**

GENERAL	7-1-1
PLATOON DRILL	7-1-1
COMPANY DRILL	7-1-1
BATTALION DRILL	7-1-1
FORMATION DRILL	7-1-1

SECTION 2 PLATOON DRILL **7-2-1**

INTRODUCTION	7-2-1
PLATOON IN LINE	7-2-1
PLATOON IN COLUMN OF THREES	7-2-2
PLATOON IN COLUMN OF ROUTE	7-2-2
DRESSING A PLATOON	7-2-3
ORDERING A PLATOON ON PARADE	7-2-4
PLATOON IN LINE ADVANCING AND RETIRING	7-2-6
PLATOON MOVING TO THE RIGHT OR LEFT IN COLUMN OF THREES	7-2-6
PLATOON MOVING TO THE RIGHT OR LEFT IN COLUMN OF ROUTE	7-2-6
PLATOON ADVANCING AND RETIRING IN COLUMN OF THREES	7-2-6
PLATOON ADVANCING AND RETIRING IN COLUMN OF ROUTE	7-2-6
PLATOON MOVING TO A FLANK, REQUIRED TO TURN ABOUT	7-2-7

SECTION 3 COMPANY DRILL **7-3-1**

INTRODUCTION	7-3-1
COMPANY FORMATIONS	7-3-1
TELLING OFF A COMPANY	7-3-5
DRESSING A COMPANY IN LINE	7-3-6
DRESSING A COMPANY IN COLUMN AND CLOSE COLUMN OF PLATOONS	7-3-6

FORMING UP A COMPANY	7-3-7
COMPANY COMMANDER'S INSPECTION	7-3-11
FALLING OUT THE OFFICERS	7-3-13
COMPANY IN (CLOSE) COLUMN OF PLATOONS FORMING COLUMN OF THREES (COLUMN OF ROUTE)	7-3-13
COMPANY IN COLUMN OF THREES (COLUMN OF ROUTE) FORMING (CLOSE) COLUMN OF PLATOONS AT THE HALT FACING A FLANK	7-3-15
COMPANY IN CLOSE COLUMN OF PLATOONS FORMING COLUMN OF PLATOONS	7-3-16
COMPANY IN COLUMN OF PLATOONS FORMING CLOSE COLUMN OF PLATOONS	7-3-17
COMPANY IN (CLOSE) COLUMN OF PLATOONS AT THE HALT MOVING TO A FLANK IN THREES	7-3-17
COMPANY IN COLUMN OF PLATOONS FORMING LINE FACING A FLANK	7-3-17
COMPANY IN LINE FORMING COLUMN OF PLATOONS FACING A FLANK	7-3-18
COMPANY IN COLUMN OF THREES ON THE MARCH FORMING COLUMN OF PLATOONS FACING A FLANK	7-3-19
COMPANY IN COLUMN OF PLATOONS FORMING LINE FACING THE SAME DIRECTION	7-3-21
COMPANY IN LINE FORMING (CLOSE) COLUMN OF PLATOONS FACING THE SAME DIRECTION	7-3-21
COMPANY IN COLUMN OF PLATOONS MOVING TO A FLANK, FORMING COLUMN OF THREES BY WHEELING	7-3-21
COMPANY IN COLUMN OF THREES FORMING COLUMN OF PLATOONS MOVING TO A FLANK BY WHEELING	7-3-21
COMPANY IN COLUMN OF PLATOONS CHANGING DIRECTION BY FORMING	7-3-23
COMPANY IN CLOSE COLUMN OF PLATOONS ON THE MARCH FORMING LINE FACING A FLANK	7-3-23
COMPANY IN CLOSE COLUMN OF PLATOONS HALTED, FORMING LINE FACING THE SAME DIRECTION	7-3-24
SECTION 4 BATTALION DRILL	7-4-1
INTRODUCTION	7-4-1
BATTALION FORMATIONS	7-4-1
TELLING OFF A BATTALION	7-4-9
DRESSING A BATTALION IN LINE	7-4-9
DRESSING A BATTALION IN COLUMN AND CLOSE COLUMN OF COMPANIES	7-4-10
DRESSING A BATTALION IN MASS	7-4-11
FORMING UP A BATTALION	7-4-11
BATTALION IN MASS MOVING OFF IN COLUMN OF THREES (COLUMN OF ROUTE)	7-4-16
BATTALION IN COLUMN OF THREES OR COLUMN OF ROUTE FORMING MASS	7-4-17
BATTALION IN (CLOSE) COLUMN OF COMPANIES MOVING OFF IN COLUMN OF THREES (COLUMN OF ROUTE)	7-4-17
BATTALION IN COLUMN OF THREES OR COLUMN OF ROUTE FORMING CLOSE COLUMN OF COMPANIES AT THE HALT FACING A FLANK	7-4-17
BATTALION IN COLUMN OF THREES OR COLUMN OF ROUTE FORMING CLOSE COLUMN OF COMPANIES AT THE HALT FACING THE SAME DIRECTION	7-4-17
CHAPTER 8 COLOURS AND FLAGS	8-1-1
SECTION 1 GENERAL	8-1-1
DEFINITIONS	8-1-1
PARADING COLOURS AND FLAGS	8-1-1
DRAPING THE COLOURS	8-1-1

SECTION 2 THE COLOUR PARTY	8-2-1
COMPOSITION OF A COLOUR PARTY	8-2-1
COMPOSITION OF A FLAG PARTY	8-2-1
DUTIES	8-2-2
ARMS AND EQUIPMENT	8-2-3
SECTION 3 COLOUR DRILL	8-3-1
GENERAL	8-3-1
POSITION OF THE ORDER	8-3-1
STAND AT EASE FROM THE ORDER	8-3-1
STAND EASY FROM STAND AT EASE	8-3-1
ORDER FROM STAND AT EASE	8-3-2
CARRY FROM THE ORDER	8-3-2
ORDER FROM THE CARRY	8-3-4
SLOPE FROM THE CARRY	8-3-4
SLOPE FROM THE ORDER (CASED COLOUR)	8-3-6
ORDER FROM THE SLOPE (CASED COLOUR)	8-3-9
CHANGING THE COLOUR AT THE SLOPE	8-3-9
CARRY FROM THE SLOPE	8-3-11
LET FLY FROM THE CARRY	8-3-11
CATCHING THE COLOUR FROM THE LET FLY	8-3-11
DIP FROM THE CARRY AT THE HALT	8-3-14
CARRY FROM THE DIP AT THE HALT	8-3-14
DIP FROM THE CARRY ON THE SLOW MARCH (CONSACRETED COLOURS ONLY)	8-3-17
CARRY FROM THE DIP ON THE MARCH	8-3-19
SECTION 4 REMOVING AND LODGING THE COLOURS	8-4-1
GENERAL	8-4-11
REMOVING THE COLOURS	8-4-11
LODGING THE COLOURS	8-4-11
SECTION 5 CASING AND UNCASING THE COLOURS	8-5-1
CASING THE COLOURS	8-5-1
UNCASING THE COLOUR	8-5-3
SECTION 6 MARCHING ON AND OFF THE COLOUR	8-6-1
MARCHING ON THE COLOUR	8-6-1
MARCHING OFF THE COLOUR	8-6-2
SECTION 7 POSITIONS OF COLOURS ON PARADE	8-7-1
BATTALION PARADE	8-7-1
GUARDS OF HONOUR	8-7-1
CHAPTER 9 BATTALION CEREMONIAL	9-1-1
SECTION 1 GENERAL	9-1-1
INTRODUCTION	9-1-1
PROMENADING	9-1-1
INSPECTIONS	9-1-3
PRESENTATIONS AND ADDRESSES	9-1-3
MOUNTED PARADES	9-1-3

BANDS	9-1-5
SECTION 2 THE BATTALION REVIEW	9-2-1
INTRODUCTION	9-2-1
SEQUENCE OF A BATTALION REVIEW	9-2-1
REVIEW PARADE GROUND	9-2-1
COMPLIMENTS AND REVIEW ORDER	9-2-2
RECEPTION OF THE REVIEWING OFFICER	9-2-3
INSPECTION	9-2-4
MARCH PAST	9-2-4
PRESENTATIONS AND ADDRESSES	9-2-5
ADVANCE IN REVIEW ORDER	9-2-5
DEPARTURE OF THE REVIEWING OFFICER	9-2-5
SECTION 3 TROOPING THE COLOUR	9-3-1
GENERAL	9-3-1
PARADE SEQUENCE	9-3-1
POSITIONING THE COLOUR PARTY	9-3-2
TROOPING THE COLOUR	9-3-2
SECTION 4 CONSECRATION AND PRESENTATION OF NEW COLOURS	9-4-1
GENERAL	9-4-1
PARADE SEQUENCE	9-4-1
MARCHING OFF THE OLD COLOURS	9-4-1
FORMATION	9-4-1
PILING DRUMS	9-4-3
OFFICERS FOR THE COLOURS	9-4-3
COLOUR ESCORT	9-4-4
COLOUR ORDERLIES	9-4-4
UNCASING THE COLOURS	9-4-4
PLACING THE COLOURS ON THE DRUMS	9-4-4
CONSECRATION	9-4-4
PRESENTATION OF COLOURS – PREPARATION	9-4-4
PRESENTATION OF COLOURS	9-4-5
SECTION 5 DEPOSITING OR LAYING UP OF COLOURS	9-5-1
GENERAL	9-5-1
LAYING UP	9-5-1
SECTION 6 FEU DE JOIE	9-6-1
GENERAL	9-6-1
FEU DE JOIE	9-6-1
ANNEX A MOUNTED PARADES	9A-1
ARMOURED REGIMENTS – GENERAL	9A-1
ARMOURED REGIMENTS – THE MOUNTED REVIEW	9A-1
ARMOURED REGIMENTS – TROOPING THE STANDARD/GUIDON	9A-3
ARTILLERY – GENERAL	9A-4
ARTILLERY – THE MOUNTED REVIEW WITH SELF-PROPELLED GUNS	9A-5
ANNEX B MODIFICATIONS TO PARADE PROCEDURES – EXAMPLE: TROOPING THE COLOUR	9B-1
INTRODUCTION	9B-1

SEQUENCE	9B-1
REORGANIZATION	9B-2
FORMING-UP ON PARADE	9B-2
INSPECTION, TROOPING THE COLOUR, MARCH PAST	9B-12
THE ADVANCE, PRESENTATION AND ADDRESS	9B-13
THE MARCH OFF	9B-13
CHAPTER 10 GUARDS, SENTRIES AND ESCORTS	10-1-1
SECTION 1 GENERAL	10-1-1
INTRODUCTION	10-1-1
COLOURS	10-1-1
PARADE FORMAT	10-1-1
SECTION 2 GUARDS OF HONOUR	10-2-2
GENERAL	10-2-2
GUARD FORMATIONS	10-2-2
FALLING IN THE GUARD	10-2-3
MOUNTING THE GUARD OF HONOUR	10-2-3
INSPECTION	10-2-3
DISMOUNTING AND DISMISSAL	10-2-5
SECTION 3 QUARTER GUARDS AND SENTRIES	10-3-1
GENERAL	10-3-1
DEFINITIONS	10-3-1
COMPOSITION OF GUARDS	10-3-1
DUTIES OF THE GUARD	10-3-2
COMPLIMENTS	10-3-2
SENTRY DRILLS	10-3-3
DOUBLE SENTRIES	10-3-5
FORMING UP THE GUARD	10-3-5
GUARD MOUNTING	10-3-6
POSTING AND RELIEVING SENTRIES	10-3-20
TURNING OUT THE GUARD	10-3-20
DISMISSING THE GUARD	10-3-21
HOUSEHOLD GUARDS	10-3-21
SECTION 4 CEREMONIAL ARRIVAL AND DEPARTURE GUARDS	10-4-1
GENERAL	10-4-1
CEREMONIAL ARRIVAL GUARD	10-4-1
DEPARTURE GUARD	10-4-1
POSITIONING THE GUARD	10-4-1
COMPLIMENTS	10-4-2
DISMISSING THE GUARD	10-4-3
CHAPTER 11 RELIGIOUS SERVICES AND FUNERALS	11-1-1
SECTION 1 RELIGIOUS SERVICES	11-1-1
REMEMBRANCE SERVICES	11-1-1
CHURCH PARADES IN CHURCHES	11-1-2
CHURCH PARADES ELSEWHERE	11-1-2

SECTION 2 FUNERALS	11-2-1
INTRODUCTION	11-2-1
THE NEXT OF KIN'S WISHES	11-2-1
THE FUNERAL PROCESSION	11-2-2
THE VIGIL	11-2-6
PROCEDURE FOR THE DEPARTURE OF THE CASKET	11-2-8
THE CHURCH SERVICE	11-2-11
PROCESSION	11-2-13
THE MOVE TO THE GRAVESIDE	11-2-15
ARRIVAL AT THE GRAVESIDE	11-2-15
GRAVESIDE SERVICE	11-2-16
CONCLUSION	11-2-18
CREMATION	11-2-18
SECTION 3 INSTRUCTIONS FOR THE BEARER PARTY, HONORARY PALLBEARERS AND INSIGNIA BEARERS	11-3-1
THE BEARER PARTY	11-3-1
PROCEDURE TO MOVE THE CASKET FROM THE CHURCH OR CHAPEL TO THE GRAVESITE	11-3-1
PROCEDURE FOR HONORARY PALLBEARERS AND INSIGNIA BEARERS	11-3-13
SECTION 4 THE UNLOADING OF A CASKET FROM AN OVERSEAS AIRCRAFT	11-4-1
GENERAL	11-4-1
COMPOSITION OF THE BEARER PARTY	11-4-1
POSITION OF THE BEARER PARTY	11-4-1
REMOVAL OF THE CASKET	11-4-1
SECTION 5 BURIAL OR SCATTERING OF ASHES AT SEA	11-5-1
BRINGING REMAINS ON BOARD SHIP	11-5-1
BURIAL	11-5-1
SCATTERING OF ASHES	11-5-2
SECTION 6 PROCESS FOR THE CEREMONIAL FOLDING OF THE NATIONAL FLAG OF CANADA	11-6-1
GENERAL	11-6-1
CHAPTER 12 MISCELLANEOUS CEREMONIAL	12-1-1
SECTION 1 STREET LINING	12-1-1
GENERAL	12-1-1
DEFINITIONS	12-1-1
STREET LINING	12-1-1
FUNERALS	12-1-4
DISPERSAL	12-1-5
SECTION 2 FREEDOM OF THE CITY	12-2-1
GENERAL	12-2-1
THE CEREMONY	12-2-1
REPORTING	12-2-1
EXERCISING THE FREEDOM	12-2-1

SECTION 3 RETREAT (SUNSET) AND TATTOO CEREMONIES	12-3-1
GENERAL	12-3-1
REVIEW OF THE GUARD	12-3-1
RETREAT (SUNSET)	12-3-2
TATTOO	12-3-2
THE DEPARTURE	12-3-2
COMPLIMENTS	12-3-2
TATTOOS INDOORS AND AT DUSK	12-3-3
SECTION 4 THE SUNSET CEREMONY (NAVAL)	12-4-1
INTRODUCTION	12-4-1
GENERAL	12-4-1
SEQUENCE OF SUNSET CEREMONY (NAVAL)	12-4-2
PERSONNEL	12-4-2
PHASE 1: THE MARCH ON	12-4-2
PHASE 2: BEATING RETREAT AND TATTOO	12-4-5
PHASE 3: THE MARCH PAST	12-4-5
PHASE 4: SECTION DRILL	12-4-5
PHASE 5: FEU DE JOIE	12-4-10
PHASE 6: THE EVENING HYMN	12-4-10
PHASE 7: SUNSET	12-4-10
PHASE 8: THE MARCH OFF	12-4-11
SECTION 5 THE CEREMONY OF THE FLAGS	12-5-1
INTRODUCTION	12-5-1
GENERAL	12-5-1
PERSONNEL	12-5-2
SEQUENCE OF THE CEREMONY OF THE FLAGS	12-5-2
PHASE 1: THE MARCH ON	12-5-3
PHASE 2: SECTION DRILL	12-5-3
FIXING BAYONETS ON THE MARCH	12-5-5
PHASE 3: FEU DE JOIE	12-5-5
PHASE 4: SALUTE TO THE FLAGS	12-5-7
PHASE 5: THE MARCH PAST	12-5-7
SUNSET	12-5-10
BAND MUSIC	12-5-10
SECTION 6 SPECIAL OCCASIONS	12-6-1
GENERAL	12-6-1
PLANNING SEQUENCE	12-6-1
FINANCES	12-6-1
GENERAL	12-6-1
TAKE UP DRAG ROPES	12-6-1
GROUND DRAG ROPES	12-6-1
QUICK MARCH	12-6-3
WHEELING	12-6-3
HALT	12-6-3
OPEN ORDER MARCH	12-6-3
UNLIMBER	12-6-3
LOAD	12-6-4
LIMBER UP	12-6-7
QUICK MARCH AFTER LIMBER UP	12-6-7
FUNERAL DRILL – GENERAL	12-6-8

FUNERAL DRILL – POSITIONING THE GUN CARRIAGE	12-6-8
FUNERAL DRILL – RECEIVING THE CASKET	12-6-8
FUNERAL DRILL – REMOVAL OF THE CASKET	12-6-11

CHAPTER 13 PROCEDURES FOR USE ON BOARD SHIP	13-1
GENERAL	13-1
CEREMONIAL DIVISIONS	13-1
DAILY DIVISIONS	13-2
EVENING QUARTERS	13-2
PROCEDURE FOR ENTERING AND LEAVING HARBOUR	13-2
MANNING AND CHEERING SHIP	13-3
GUARDS	13-4
COLOURS	13-4
GUARDS OF HONOUR	13-5
SALUTING ON BOARD	13-5
PIPING THE SIDE	13-6

CHAPTER 14 BAND DRILL	14-1-1
SECTION 1	14-1-1
INTRODUCTION	14-1-1
GENERAL	14-1-1
DIRECTION AND CONTROL – KEY PARADE APPOINTMENTS	14-1-1
MUSICAL MARCHING DISPLAYS	14-1-2
STARTING MUSIC ON PARADE	14-1-2

SECTION 2	14-2-1
INSTRUMENT DRILL	14-2-1
BASIC POSITIONS	14-2-1
CHANGING POSITIONS	14-2-1
INTERMEDIATE POSITION	14-2-1
PLAYING POSITION FROM THE CARRYING POSITION	14-2-1
CARRYING POSITION FROM THE PLAYING POSITION	14-2-2
CHANGING MUSIC	14-2-2
GROUNDING AND TAKING UP INSTRUMENTS	14-2-3
COMPLIMENTS (SALUTING)	14-2-3

SECTION 3	14-3-1
CONDUCTOR AND DRUM MAJOR	14-3-1
GENERAL	14-3-1
INDICATIONS FROM CONDUCTOR	14-3-1
BATON CARRIAGE	14-3-1
POSITIONING ON THE MARCH	14-3-2
EXCHANGING POSITIONS AT THE HALT	14-3-2
SALUTING ON THE MARCH IN QUICK TIME	14-3-3
SALUTING ON THE MARCH IN SLOW TIME	14-3-3

SECTION 4	14-4-1
BAND FORMATIONS	14-4-1
AND MANOEUVRE	14-4-1
GENERAL	14-4-1
BASIC BAND FORMATIONS	14-4-1

ORDERING A BAND ON PARADE	14-4-2
DISMISSING A BAND ON PARADE	14-4-2
WHEELS	14-4-2
STANDARD COUNTERMARCH	14-4-3
SPIRAL COUNTERMARCH	14-4-3
SPECIAL WHEELING MANOEUVRES	14-4-4
SECTION 5	14-5-1
VISUAL AND AUDIBLE	14-5-1
CONTROL SIGNALS AND MACE DRILL	14-5-1
GENERAL	14-5-1
DRUM MAJOR - STANDARD MACE DRILL POSTURES AND MOTIONS	14-5-1
ATTENTION, STAND AT EASE AND STAND EASY	14-5-1
THE CARRY	14-5-2
SALUTING	14-5-2
THE TRAIL	14-5-2
HALTING	14-5-3
MARCHING A BAND OFF PARADE	14-5-3
THE STATE WALK AND WALKING THE MACE	14-5-3
DECORUM	14-5-4
PARADE CANE	14-5-4
STANDARD VISUAL AND AUDIBLE CONTROL SIGNALS	14-5-4
STEPPING OFF AND MARKING TIME	14-5-5
STEPPING OFF	14-5-5
MARKING TIME	14-5-5
HALTING	14-5-6
COMMENCE PLAYING	14-5-7
CEASE PLAYING	14-5-8
SIMULTANEOUS CEASE PLAYING WHILE HALTING	14-5-9
CHANGING MARCH TEMPO	14-5-9
WHEEL SIGNALS	14-5-10
STANDARD COUNTERMARCH SIGNAL AND ACTION	14-5-10
SPIRAL COUNTERMARCH SIGNAL AND ACTION	14-5-11
PIVOT AND SPIN WHEEL SIGNALS	14-5-11
MASSED BANDS COORDINATION SIGNALS	14-5-12
SECTION 6	14-6-1
PARADE PROCEDURES AND TECHNIQUES	14-6-1
ANNEX A	14-A-1
GENERAL	14-A-1
QUICK MARCH	14-A-1
SLOW MARCH	14-A-1
STEPPING OFF	14-A-1
MARKING TIME	14-A-2
HALTING	14-A-2
CEASE PLAYING	14-A-2
CHANGE OF CADENCE	14-A-2
ANNEX B	14-B-1

LIST OF FIGURES

Figure 1-1-1	Appointment Symbols	1-1-3
Figure 2-1	Squad Formations	2-1
Figure 2-2	Position of Attention	2-2
Figure 2-3	Position of Stand at Ease from Attention	2-3
Figure 2-4	Position of Stand Easy	2-4
Figure 2-5	Carrying of Articles	2-5
Figure 2-6	Remove Headdress	2-6
Figure 2-7	Stand Easy with Headdress Removed	2-7
Figure 2-8	Saluting, at the Halt, without Arms	2-8
Figure 2-9	Right Turn	2-9
Figure 2-10	About Turn	2-10
Figure 2-11	Dressing a Squad	2-13
Figure 2-12	Open Order – March (Three Ranks)	2-15
Figure 2-13	Open Order – March (Two Ranks)	2-16
Figure 2-14	Falling out of Individuals	2-17
Figure 2-15	Falling in of Individuals	2-18
Figure 2-16	Sizing in Three Ranks	2-19
Figure 2-17	Sizing in Single Rank	2-20
Figure 3-1	Advance/Retire and Directing Flanks	3-4
Figure 3-2	Marching in Quick Time	3-5
Figure 3-3	Halting in Quick Time	3-6
Figure 3-4	Marching in Double Time	3-7
Figure 3-5	Marching in Slow Time	3-8
Figure 3-6	Halting in Slow Time	3-9
Figure 3-7	Marking Time in Slow Time	3-10
Figure 3-8	Marking Time in Quick Time	3-11
Figure 3-9	Wheeling	3-14
Figure 3-10	Change Step on the March in Quick Time	3-15
Figure 3-11	Forming Hollow Square	3-17
Figure 3-12	Saluting on the March without Arms	3-18
Figure 3-13	Eyes Right on the March without Arms	3-19
Figure 3-14	Turns in Slow Time	3-20
Figure 3-15	Turns in Quick Time	3-22
Figure 3-16	About Turn in Slow Time	3-24
Figure 3-17	About Turn in Quick Time	3-25
Figure 3-18	Forming from the Halt	3-28
Figure 3-19	Forming Squad from the Halt	3-31
Figure 3-20	Squad in Threes Forming Single File	3-32
Figure 3-21	Squad in Line Forming Single File	3-33
Figure 3-22	Squad in Single File Reforming Line from the Halt	3-34
Figure 4-1-1	C7A2 Rifle	4-1-2
Figure 4-1-2	Position of Attention	4-1-3
Figure 4-1-3	Position of Stand at Ease	4-1-4
Figure 4-1-4	Position of Stand Easy from Stand at Ease	4-1-5
Figure 4-1-5	Short Trail	4-1-6
Figure 4-1-6	Ground Arms	4-1-7
Figure 4-1-7	Shoulder Arms from the Order	4-1-8
Figure 4-1-8	Order Arms from the Shoulder	4-1-9
Figure 4-1-9	Present Arms from the Shoulder	4-1-11
Figure 4-1-10	Shoulder Arms from the Present	4-1-12
Figure 4-1-11	Fix Bayonets	4-1-13
Figure 4-1-12	Unfix Bayonets	4-1-15

Figure 4-1-13	Examine Arms from the Order	4-1-17
Figure 4-1-14	Ease Springs – Six	4-1-19
Figure 4-1-15	Order Arms from the Examine	4-1-20
Figure 4-1-16	Salute at the Shoulder	4-1-21
Figure 4-1-17	Port Arms from the Order	4-1-22
Figure 4-1-18	Order Arms from the Port	4-1-23
Figure 4-1-19	Port Arms from the Shoulder	4-1-24
Figure 4-1-20	Shoulder Arms from the Port	4-1-25
Figure 4-1-21	Trail Arms from the Shoulder	4-1-26
Figure 4-1-22	Shoulder Arms from the Trail	4-1-27
Figure 4-1-23	Change Arms at the Trail	4-1-28
Figure 4-1-24	Charge Arms at the Shoulder	4-1-29
Figure 4-1-25	Sling Arms	4-1-30
Figure 4-2-1	Recover Arms from the Shoulder	4-2-1
Figure 4-2-2	Rest on our Arms Reversed from the Present	4-2-2
Figure 4-2-3	Present Arms from the Rest on your Arms Reversed	4-2-3
Figure 4-2-4	Firing Cartridges from the Order	4-2-4
Figure 4-2-5	Reverse Arms from the Shoulder	4-2-7
Figure 5-1-1	Shoulder Arms (Position of Attention)	5-1-1
Figure 5-1-2	Position of Stand at Ease	5-1-2
Figure 5-1-3	C8 Carbine	5-1-3
Figure 5-1-4	Ground Arms from the Shoulder	5-1-4
Figure 5-1-5	Fix Bayonets	5-1-5
Figure 5-1- 6	Unfix Bayonets	5-1-7
Figure 5-1-7	Examine Arms from the Shoulder	5-1-9
Figure 5-1-8	Shoulder Arms from the Examine	5-1-11
Figure 6-1-1	Sword and Accoutrements	6-1-3
Figure 6-1-2	Attention (slung), Carry, Recover	6-1-5
Figure 6-1-3	Stand at Ease	6-1-7
Figure 6-1-4	Draw Swords (sword hooked-up)	6-1-8
Figure 6-1-5	Return Swords from the Carry	6-1-9
Figure 6-1-6	Quick March (slung) Figure 6-1-6A Quick March (hooked up)	6-1-11
Figure 6-1-7	Saluting with the Sword	6-1-12
Figure 6-1-8	Saluting on the March in Slow Time	6-1-13
Figure 6-1-9	The Arch	6-1-15
Figure 6-1-10	Rest on your Arms Reversed from the Salute	6-1-16
Figure 6-1-11	Reverse Arms	
Figure 6-1-12	Position when Seated	6-1-19
Figure 6-2-1	Pace Stick	6-2-20
Figure 6-2-2	Attention or Carry Position	6-2-21
Figure 6-2-3	Stand at Ease at the Carry	6-2-22
Figure 6-2-4	Stand at Ease at the Shoulder	6-2-23
Figure 6-2-5	Trail from the Carry Position on the March	6-2-25
Figure 6-2-6	Salute at the Carry	6-2-26
Figure 6-2-7	Attention, Pace Stick Open	6-2-27
Figure 6-2-8	Stand at Ease	6-2-28
Figure 6-2-9	Marching and Halting, not Pacing	6-2-29
Figure 6-2-10	Pacing	6-2-30
Figure 6-2-11	Saluting, Pace Stick Open	6-2-31
Figure 7-2-1	Platoon in Line	7-2-2
Figure 7-2-2	Platoon in Column of Threes	7-2-3
Figure 7-2-3	Platoon in Column of Route	7-2-4
Figure 7-2-4	Platoon Drill	7-2-5
Figure 7-3-1	Company in Line	7-3-2
Figure 7-3-2	Company in Column of Threes	7-3-3

Figure 7-3-3	Company in Column of Route	7-3-4
Figure 7-3-4	Company in Column of Platoons	7-3-5
Table 7-3-1	(Sheet 1 of 3) Forming Up a Company	7-3-8
Figure 7-3-5	Officers Fall in	7-3-11
Figure 7-3-6	Company Commander's Inspection: Company in Line, Column or Close Column of Platoons	7-3-12
Figure 7-3-7	Company Drill	7-3-14
Figure 7-3-8	Company Drill: Column of Platoons to Column of Threes and Vice Versa	7-3-15
Figure 7-3-9	Company in Line Forming Column of Platoons Facing a Flank	7-3-18
Figure 7-3-10	Company in Column of Threes On the March Forming Column of Platoons Facing a Flank	7-3-20
Figure 7-3-11	Company in Column of Threes Forming Column of Platoons Facing the Same Direction	7-3-22
Figure 7-3-12	Company in Column of Platoons Changing Direction by Forming	7-3-24
Figure 7-4-1	Battalion in Lin	7-4-3
Figure 7-4-2	Battalion in Column of Threes	7-4-4
Figure 7-4-3	Battalion in Column of Route	7-4-6
Figure 7-4-4	Battalion in Column (Close Column) of Companies	7-4-7
Figure 7-4-5	Battalion in Mass	7-4-8
Table 7-4-1	(Sheet 1 of 4) Forming Up a Battalion	7-4-12
Figure 8-1-1	Draping the Colour	8-1-2
Figure 8-2-2	Colour Party for One Colour	8-2-2
Figure 8-2-3	Details of the Colour Pike and Belt	8-2-3
Figure 8-3-1	Position of the Order (uncased and Figure 8-3- 2 Stand at Ease cased)	8-3-2
Figure 8-3-3	Carry from the Order	8-3-3
Figure 8-3-4	Order from the Carry	8-3-5
Figure 8-3-5	Slope from the Carry	8-3-7
Figure 8-3-6	Slope from the Order (Cased Colour)	8-3-8
Figure 8-3-7	Order from the Slope (Cased Colour)	8-3-9
Figure 8-3-8	Changing the Colour at the Slope	8-3-10
Figure 8-3-9	Carry from the Slope	8-3-12
Figure 8-3-10	Let Fly from the Carry	8-3-13
Figure 8-3-11	Catching the Colour from the Let Fly	8-3-15
Figure 8-3-12	Dip from the Carry at the Halt	8-3-16
Figure 8-3-13	Dip Position – Wet Ground	8-3-17
Figure 8-3-14	Dip from the Carry on the March	8-3-18
Figure 8-5-1	Casing and Uncasing the Colours	8-5-2
Figure 8-6-1	Marching on and off the Colour (Battalion in Line)	8-6-2
Figure 8-7-1	Colours on Parade (Battalion in Close Column)	8-7-2
Figure 8-7-2	Position Colours on Parade (Battalion in Mass)	8-7-3
Figure 9-1-1	Inspection of Battalion in Close Column and Column	9-1-2
Figure 9-1-2	Inspection of Battalion in Mass	9-1-4
Figure 9-1-3	Inspection of Battalion in Line	9-1-5
Figure 9-2-1	Review Parade Ground	9-2-2
Table 9-2-1	(Sheet 1 of 4) March Past in Column of Route	9-2-6
Figure 9-2-2	March Past in (Close) Column of Companies in Quick Time	9-2-10
Table 9-2-2	(Sheet 1 of 3) March Past in Column (Close Column) of Companies in Quick Time	9-2-11
Table 9-2-3	(Sheet 1 of 3) March Past in Column (Close Column) in Slow and Quick Time	9-2-14
Figure 9-3-1	The Escort Receiving the Colour	9-3-2
Table 9-3-1	(Sheet 1 of 6) Trooping the Colour	9-3-4
Table 9-4-1	Marching off the Old Colours	9-4-2
Figure 9-4-1	Piling Drums	9-4-3
Figure 9-4-2	Consecration of Colours	9-4-6
Table 9-6-1	(Sheet 1 of 3) Feu de Joie	9-6-2

Figure 9A-1	Artillery – Position of Vehicles	9A-6
Figure 9A-2	Artillery – Drive Past	9A-7
Figure 9B-1	March on for Trooping the Colour	9B-4
Figure 9B-2	Officers and WOs Prior to Taking Post in Front of their Guards	9B-5
Table 9B-1	(Sheet 1 of 4) Forming under the Adjutant	9B-6
Table 9B-2	(Sheet 1 of 2) Fall in the Officers	9B-10
Figure 9B-3	The Escort Receiving the Colour	9B-12
Table 9B-3	(Sheet 1 of 2) The March off	9B-14
Figure 10-2-1	Guard of Honour Formations	10-2-4
Table 10-3-1	Composition of Quarter Guards	10-3-1
Figure 10-3-1	Sentry Post with Double Sentries	10-3-4
Figure 10-3-2	Guard Formed up under the Corporal of the Guard	10-3-6
Table 10-3-2	(Sheet 1 of 11) Guard Mounting	10-3-7
Figure 10-3-3	Guard Formed up Ready for Mounting	10-3-18
Figure 10-3-4	Guard Mounting (No. 6)	10-3-18
Figure 10-3-5	Guard Mounting (No. 29)	10-3-19
Figure 10-3-6	Guard Mounting (No. 47)	10-3-19
Figure 10-3-7	Quarter Guard after Being Turned ou	10-3-22
Figure 10-4-1	Departure Guard	10-4-2
Figure 11-1-1	Drumhead Service	11-1-3
Table 11-2-1	(Sheet 1 of 2) The Funeral Procession in Order of March	11-2-3
Table 11-2-2	Composition of Funeral Parties	11-2-5
Figure 11-2-1	The Vigil	11-2-7
Figure 11-2-2	Posting the Vigil	11-2-9
Figure 11-2-3	Relieving the Vigil	11-2-10
Figure 11-2-4	The Church Seating Plan	11-2-12
Figure 11-2-5	Procession	11-2-14
Figure 11-2-6	Suggested Positions of Funeral Party at Gravesite	11-2-17
Figure 11-3-1	Prepare to Lift	11-3-5
Figure 11-3-2	Raise – Final Position	11-3-6
Figure 11-3-3	Outwards	11-3-7
Figure 11-3-4	Turn	11-3-8
Figure 11-3-5	Lowering the Casket	11-3-9
Figure 11-3-6	Lifting the Caske	11-3-11
Figure 11-3-7	Lowering the Casket	11-3-12
Figure 11-5-1	Arrival at Ship's Side	11-5-2
Figure 11-6-1	Flag folding procedure	11-6-2
Table 12-1-1	(Sheet 1 of 2) Street Lining	12-1-2
Figure 12-1-1	Street Lining	12-1-4
Figure 12-4-1	Sunset Ceremony – Phase 1: The March On	12-4-4
Figure 12-4-2	Sunset Ceremony – Phase 2: The Drums	12-4-6
Figure 12-4-3	Sunset Ceremony – Phase 2: The Buglers	12-4-7
Figure 12-4-4	Sunset Ceremony – Phase 3-1	12-4-8
Figure 12-4-5	Sunset Ceremony – Phase 3-2	12-4-9
Table 12-4-1	Preparation for the Feu de Joie	12-4-10
Figure 12-5-1	Ceremony of the Flags – Phase 1	12-5-4
Figure 12-5-1	Ceremony of the Flags – Phase 2	12-5-6
Table 12-5-1	The Feu de Joie	12-5-8
Figure 12-5-3	Ceremony of the Flags – Phase 4	12-5-9
Table 12-5-2	Ceremony of the Flags: Sunset	12-5-11
Figure 12-5-4	Ceremony of the Flags – Phase 5	12-5-12
Figure 12A-1	Order of March, Gun Carriage Crew	12A-2
Figure 12A-2	Open Order March	12A-5
Figure 12A-3	The Load Position	12A-6

Figure 12A-4	Naval Gun Crew – State Funeral	12A-9
Figure 12A-5	Naval Gun Crew – Military Funeral	12A-10
Figure 13-1	Divisions	13-2
Figure 13-2	Hands to Station – Entering and Leaving Harbour	13-4
Figure 14-2-1	Drill Positions for Piccolo	14B-1
Figure 14-2-2	Drill Positions for Clarinet and Oboe	14B-12
Figure 14-2-3	Drill Positions for Bassoon	14B-13
Figure 14-2-4	Drill Positions for Alto and Tenor Saxophone	14B-14
Figure 14-2-5	Drill Positions for Baritone Saxophone	14B-15
Figure 14-2-6	Drill Positions for French Horn	14B-16
Figure 14-2-7	Drill Positions for French Horn When Wearing Sword/Bayonet	14B-17
Figure 14-2-8	Drill Positions for Trumpet	14B-18
Figure 14-2-9	Drill Positions for Trombone	14B-19
Figure 14-2-10	Drill Positions for Euphonium	14B-10
Figure 14-2-11	Drill Positions for Tuba	14B-11
Figure 14-2-12	Drill Positions for Snare Drum and Tenor Drum (Side Slung) (A)	14B-12
Figure 14-2-13	Drill Positions for Snare Drum (Flat Mount) (A)	14B-14
Figure 14-2-14	Drill Positions for Bass Drum (A)	14B-16
Figure 14-2-15	Drill Positions for Cymbals	14B-18
Figure 14-2-16	Drill Positions for Bagpipes (A)	14B-19
Figure 14-2-17	Drill Positions for Piston Bugle and Bugle (A)	14B-21
Figure 14-2-18	Drill Positions for Fanfare Trumpet	14B-23
Figure 14-2-19	Drill Positions for Bell Lyre	14B-24
Figure 14-3-1/A	Conductor – Starting a March at the Halt	14B-25
Figure 14-3-2	Conductor – Conducting and Ending a March	14B-27
Figure 14-3-3	Conductor – Baton Carriage	14B-28
Figure 14-4-1	Basic Band Formation, Even Number of Files	14B-29
Figure 14-4-2	Basic Band Formation, Odd Number of Files	14B-30
Figure 14-4-3	Band Formation, Pipes and Drums	14B-31
Figure 14-4-4	Band Formation, Corps of Drums/Fifes/Trumpets/Bugles	14B-32
Figure 14-4-5	Standard Countermarch	14B-33
Figure 14-4-6	Spiral Countermarch – Band With Even Number of Files	14B-34
Figure 14-4-7	Spiral Countermarch – Band With Odd Number of Files	14B-35
Figure 14-5-1	Drum Major’s Mace and Parade Cane	14B-36
Figure 14-5-2	Drum Major – Basic Positions	14B-37
Figure 14-5-3	Drum Major – Carry Position While Marching, and Rolling the Mace	14B-38
Figure 14-5-4	Drum Major – Stepping Off Into the Carry in Quick Time	14B-39
Figure 14-5-5	Drum Major – Stepping Off Into the Carry in Slow Time	14B-40
Figure 14-5-6	Drum Major - Saluting	14B-41
Figure 14-5-7	Drum Major – Stepping Off into the Trail	14B-42
Figure 14-5-8	Drum Major – Changing from the Carry to the Trail in Quick Time: Viewed from the Left	14B-43
Figure 14-5-9	Drum Major – Changing from Carry to the Trail in Quick Time: Viewed from the Right	14B-44
Figure 14-5-10	Changing from the Carry to the Trail in Slow Time	14B-45
Figure 14-5-11	Drum Major – Changing from the Trail to the Carry in Quick Time	14B-46
Figure 14-5-12	Drum Major – Changing from the Trail to the Carry in Slow Time	14B-47
Figure 14-5-13	Drum Major – Halting When Marching At the Trail	14B-48
Figure 14-5-14	Drum Major – The State Walk in Slow Time	14B-49
Figure 14-5-15	Drum Major – Walking the Mace in Quick Time	14B-50
Figure 14-5-16	Drum Major – Stepping Off From the Halt	14B-51
Figure 14-5-17	Drum Major – Mark Time (A)	14B-52
Figure 14-5-18	Drum Major – Halting a Band	14B-54
Figure 14-5-19	Drum Major – Commence Playing at the Halt	14B-55
Figure 14-5-20	Drum Major – Commence Playing on the March	14B-56
Figure 14-5-21	Drum Major – Cease Playing at the Halt (A)	14B-57

Figure 14-5-22	Drum Major – Cease Playing on the March (A)	14B-59
Figure 14-5-23	Drum Major – Simultaneous Halt and Cease Playing	14B-61
Figure 14-5-24	Drum Major – Changing March Tempo	14B-62
Figure 14-5-25	Drum Major – Right Wheel	14B-63
Figure 14-5-26	Drum Major - Left Wheel (A)	14B-64
Figure 14-5-27	Drum Major – Standard Countermarch	14B-66
Figure 14-5-28	Drum Major – Spiral Countermarch (A)	14B-67
Figure 14-5-29	Drum Major – Common Coordination Signal	14B-69
Figure 14-5-30	Drum Major – Circling the Mace and Dipping the Mace	14B-70
Figure 14-5-31	Drum Major – Mark Time Signal for Massed Bands	14B-71

CHAPTER 1

INTRODUCTION

SECTION 1

GENERAL

PURPOSE

1. This publication provides guidance and establishes uniformity for drill and ceremonial throughout the Canadian Armed Forces (CAF).

AIM

2. The aim of drill and ceremonial is to contribute to the operational effectiveness of the CAF by:
 - a. ensuring that the CAF efficiently march and manoeuvre together as one in duty and routine; and
 - b. promoting discipline, alertness, precision, pride, steadiness and the cohesion necessary for success.
3. Drill is the basis of all teamwork.

ORIGINS

4. At one time, drill and tactics were the same, much of the former being movements needed on the battlefield. Battle drills have existed since ancient times. The Romans are reputed to have used cadence marching for tactical formations. Although infantry supremacy and precise drills were eclipsed after the fall of the Roman Empire, and during the feudal era mounted knights ruled combat, infantry drills were resurrected in the 14th Century and slowly developed and improved thereafter. Separate drill procedures for cavalry, artillery, infantry and others (except for equipment drill) were replaced by all arms drill early in the 20th Century as the changed conditions of war gradually divorced tactics from barrack routine.

5. The foot and arms drill of the Royal Canadian Navy, Canadian Army and Royal Canadian Air Force were generally similar, being derived from the same tactical practices. When the three services were unified in 1968, evolution continued by blending the drill detail back into one.

6. Drill is still used routinely to move troops in an orderly and efficient manner. It also forms the basis of the precise manoeuvres used in military displays and ceremonies.

TERMINOLOGY

7. In this manual, “shall”, “will”, “is” and “are” are to be construed as imperative, and “may” as permissive (see Annex A for definitions).

8. The term “officer” includes all personnel holding a commissioned rank. The term “non-commissioned member” denotes personnel from the rank of private up to and including chief warrant officer.

9. Throughout this manual, words importing masculine gender include the feminine one. Where appropriate, the female address “Ma’am”, “Ms” or “Miss” shall be used in place of the male address “Sir”.

10. For ease of reference, this manual standardizes organizational terminology to include “battalion”, “company”, “platoon” and “section”. Parade commanders shall actually use the correct term for the organization under their command; e.g., flight or troop in place of platoon.

GENERAL

11. The recruit and junior officer first observe unit organization and the chain of command on the parade square. Here, the officers, warrant officers and non-commissioned officers all have their own duties and functions to perform.

12. Officers cannot delegate their parade duties to non-commissioned officers. Officers should not be drilled by Warrant Officers or non-commissioned officers, except in the case of the initial training of junior officers and refresher instruction under the actual supervision of the commanding officer or adjutant. Officers, warrant officers and non-commissioned officers ensure the respect due to them by their parade appointments by maintaining a command presence and individual drill standard of the highest order.

13. The parade ground provides an excellent opportunity for warrant officers and non-commissioned officers to display initiative and gain command experience, provided they are permitted freedom of action. Superiors who undermine a subordinate's authority fail in their own exercise of command.

DRILL AND PROCEDURE

14. **Drill.** Drill is composed of standard postures, movements and evolutions completed in response to particular words of command; e.g., "ATTEN – TION" and "PRESENT – ARMS". No deviations are allowed unless specifically mentioned in this manual to ensure that the CAF marches and manoeuvres as one.

15. **Procedure.** Procedures are the combinations of drill movements carried out for the ceremony or duty involved. Commanders may adjust procedures to suit parade circumstances and location, so long as the essential ingredients and customary sequence of traditional parades are recognized. Guidelines are provided in subsequent chapters as required.

16. **Exhibitions and Displays.** Special drill sequences, using standard drill movements, may be performed during displays such as tattoos or military pageants, often to memorized routines and without the normal sequence of commands.

DRILL STANDARDS

17. The hallmarks of CAF drill are efficiency, precision and dignity. These qualities are developed through self-discipline and practice. They lead to unit pride and cohesion.

18. Exaggerated or modified drill movements and idiosyncrasies demonstrate inefficient and undisciplined training, and a failure of the unit to focus on the purpose and use of drill in a modern armed force.

19. Military troops which display constant competence in drill are recognized universally as highly trained, well-disciplined and professional. Drill that is well taught and executed develops individual pride, mental alertness, precision and esprit-de-corps which will assist the individual service member to carry out orders instinctively at all times.

20. Good drill, well rehearsed, closely supervised and precise, is an exercise in obedience and alertness. It sets the standard for the execution of any duty, both for the individual and the unit, and builds a sense of confidence between commander and subordinate that is essential to high morale.

21. The personal qualities developed on the parade ground must be maintained in all aspects of military life. Commanders must insist on the same high standards both on and off parade to instill these qualities strongly enough to endure the strain of military duty in peace or war. The systematic correction of minor errors strengthens these characteristics and improves both individual and unit standards.

21A. Canadian Armed Forces personnel, whether as individuals or formed contingents, are forbidden to use the drill movement of a foreign military or domestic organization. Only the CDS can personally, in writing, waive this direction. Requests for waivers must be staffed through the chain-of-command to DHH.

SYMBOLS

22. The appointment symbols used in this manual are illustrated in Figure 1-1-1.

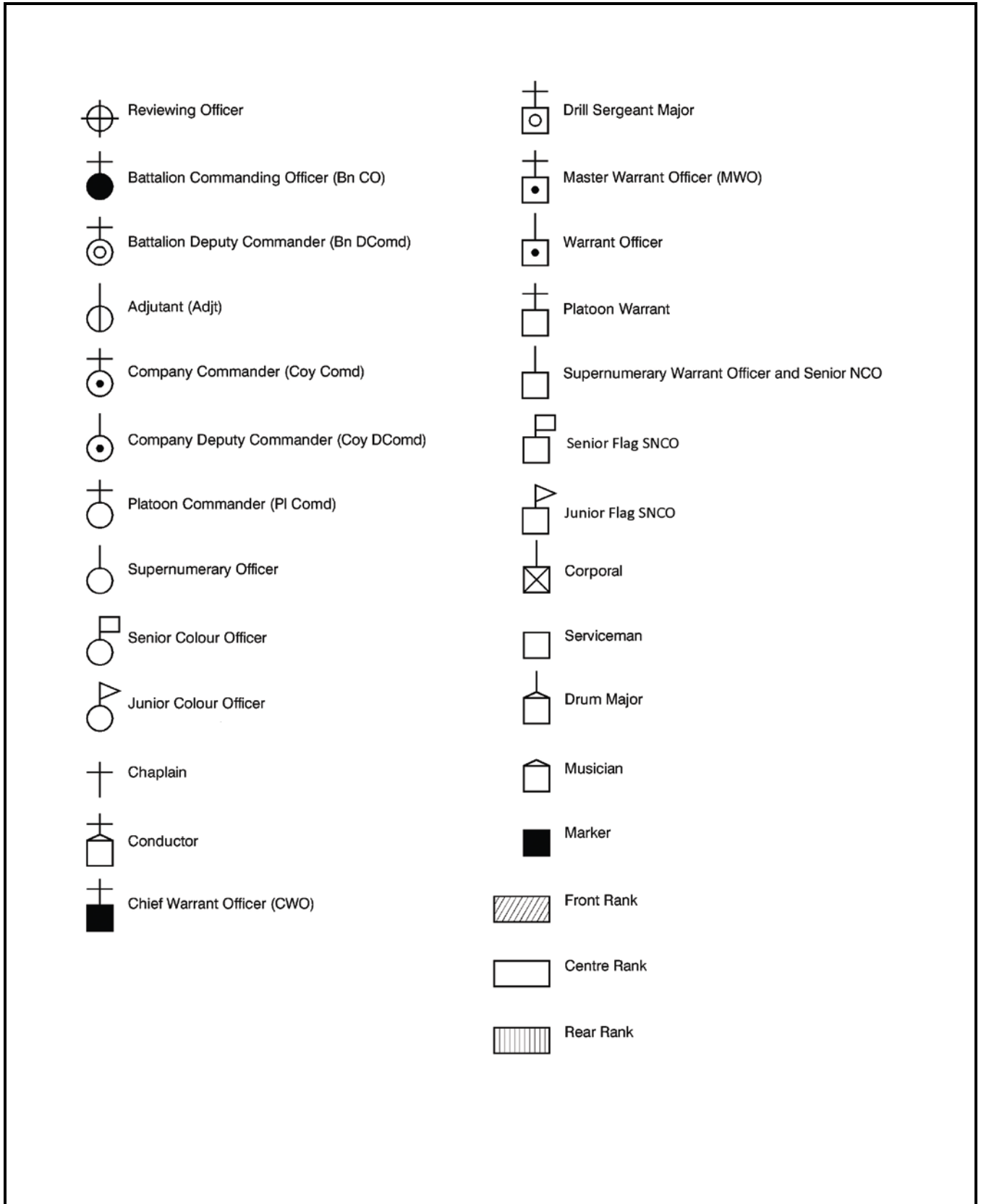

Figure 1-1- 1 Appointment Symbols

INSTRUCTION TECHNIQUES

23. **General.** The instructor must continually work to improve the standard of instruction. The techniques in this article shall be adhered to, thus ensuring the success of the drill instruction.
24. **Instructor's Appearance and Bearing.** Since example is imitated, the instructor's appearance and bearing must be of the highest standard. When conducting drill instruction, the instructor shall stand at attention unless it is necessary to demonstrate or to check an individual. The instructor shall execute all movements correctly and smartly.
25. **Demonstrations.** Demonstrations shall be planned so that the squad can see the position or movement. All demonstration shall be correct. Excessive demonstration is a common fault and shall be avoided. Arms drill shall be demonstrated using the appropriate weapon.
26. **Checking.** Constant checking and correcting of all faults is essential. Faults shall be corrected immediately after they occur.
27. **Vocabulary.** The instructor shall develop and use a vocabulary of short, concise words to impress on the squad that the movement must be performed smartly. For example, the words "crack", "drive", "seize" and "grasp" suggest the degree of smartness required. Profanity or personal sarcasm shall never be used.
28. **Manhandling.** An instructor shall not strike or push members of the squad. This does not preclude the instructor, without being offensive, from assisting in the correction of a squad member's position.
29. **Rest Periods.** In the early stages of recruit training, short rest periods shall be given during drill instruction by standing the squad easy. During these rest periods, the squad may be questioned on subjects previously taught. The squad shall not be kept in any one position long enough to produce strain and fatigue. Periods of drill at the halt shall be interspersed with movements on the march, with or without arms, at appropriate intervals to keep the squad alert, exercise the muscles, and, as a result, produce a high standard of drill.
30. **Formation for Instruction.** The instructor shall select the most effective squad formation for the lesson being taught. A squad may be in a single rank, hollow square or semi-circle for elementary drill instruction.
31. **Instructor Faults.** Faults made by an instructor and noted by a superior shall be corrected as soon as possible. The instructor shall not be corrected within earshot or sight of the squad.

CONDUCT OF A DRILL LESSON

32. **Preliminaries.** Before commencing the lesson, the instructor shall:
- a. review any appropriate previous lesson;
 - b. order the squad into a suitable formation, e.g., hollow square;
 - c. state the movement to be taught and the reason for learning; and
 - d. state the requirement of the performance check or standard.
33. **Lesson.** The lesson shall be taught in the following stages:
- a. Stage 1: Demonstration and Walk-Through.
 - (1) Demonstrate the complete movement, calling out the time.
 - (2) Demonstrate the first part of the movement.
 - (3) Explain how the first part of the movement is done.

- (4) Give the squad the opportunity to ask questions.
 - (5) Practice the squad on the first movement (collectively, individually, collectively).
 - (6) Teach the second and each subsequent movement following the sequence described above.
 - (7) Give two complete and final demonstrations.
- b. Stage 2: Practice the Complete Movement.
- (1) Practice the complete movement, with the instructor calling the time.
 - (2) Practice the complete movement, with the squad calling the time.
 - (3) Practice the complete movement, with the squad judging the time.

NOTE

On difficult movements or movements with several stages, a further demonstration may be given prior to practising the complete movement.

34. **Performance Check/Test.** Conduct the test.
35. **Conclusion.** The lesson shall be summarized as follows:
- a. restate the movement taught and the reason for learning;
 - b. state the level of achievement; and
 - c. state the next lesson.

WORDS OF COMMAND

36. Good drill depends on properly delivered words of command. They are to be pronounced clearly and distinctly, with confidence and determination, since they convey an order which is to be promptly obeyed.
37. Words of command are divided into:
- a. cautionary commands; and
 - b. executive commands.
38. The cautionary command warns of the movement to be performed and shall be given first. The cautionary command may include additional instructions such as "ADVANCE", "RETIRE", etc. The executive command serves as the signal for the movement to be carried out. Throughout this manual, words of command are printed in capital letters. A dash separates the cautionary from the executive portion of the command, e.g., RIGHT IN – CLINE.
39. As a guide, the cautionary command should be drawn out over at least two paces of quick time and the interval between the cautionary and executive commands should be two paces. The pause will be as consistent as possible.
40. AS YOU WERE shall only be ordered when another word of command cannot be used to have a squad adopt a previous position or to cancel an incorrect order before it has been completed.
41. The following are examples of correct words of command:

- a. SQUAD, MOVE TO THE RIGHT IN THREES, RIGHT – TURN, BY THE LEFT, QUICK – MARCH;
- b. PLATOON, GENERAL SALUTE, PRESENT – ARMS;
- c. NO. 1 PLATOON, AT THE HALT, ON THE LEFT, FORM PLA – TOON;
- d. COMPANY, ON THE LEFT, INTO CLOSE COLUMN, FORM PLA – TOONS; and
- e. BATTALION, MOVE TO THE RIGHT IN COLUMN OF ROUTE, RIGHT – TURN.

42. Troops fall in on parade in line, with their front rank remaining the same until dismissed. The cautionary commands ADVANCE and RETIRE indicate a turn or movement in the direction of the front or rear rank (see also Chapter 3, paragraphs 9 to 11 and Chapter 7, paragraph 1). Thus:

- a. SQUAD RETIRE, RIGHT – TURN, for a squad halted or moving to the right in threes and required to turn to the right;
- b. SQUAD ADVANCE, RIGHT – TURN, for a squad halted or moving to the left in threes and required to turn to the right;
- c. SQUAD RETIRE, ABOUT – TURN, for a squad advancing and required to turn about; and
- d. SQUAD, MOVE TO THE LEFT, RIGHT – TURN, for a squad retiring and required to turn to the left flank.

43. SQUAD ADVANCE (RETIRE) is used whenever turning into line. After every turn, the directing flank is given BY THE LEFT (RIGHT).

44. Light infantry (less Princess Patricia's Canadian Light Infantry, which drills as a line regiment) and rifle regiments, which maintain traditions of special agility and alertness on the battlefield, may use combined orders when addressing only their own troops or like units; e.g., SQUAD WILL TURN AND MOVE TO THE RIGHT IN THREES. AT THE SHOULDER, QUICK – MARCH. The squad will carry out each order in sequence.

NOTE

Words of Command are given in the primary language of the unit. As such, In a unilingual English language unit then words of command are normally in English only. In units designated as bilingual, both official languages are used. In this case, foot drill will be done in the language of the majority on parade while weapons drill will be conducted in the other official language.

STANDARD PAUSE

45. The standard pause between each drill movement is two beats of quick time.
46. In the early stages of training, the squad shall call out the time when executing drill movements.
47. To warn the squad that the time is to be called out, the instructor will precede the command for the movement with the cautionary command CALLING OUT THE TIME. For example, on the command CALLING OUT THE TIME, RIGHT – TURN, the squad:
 - a. executes the first movement of the turn on the executive order and simultaneously calls out "One";
 - b. after completing the first movement, calls "Two", "Three" while observing the standard pause; and
 - c. when executing the final movement, calls out "One".

48. After completing a movement on the march, a recruit squad shall call the step for three paces; e.g., on quick march, "Left-Right-Left".

MECHANICAL TRAINING AIDS

49. **Drums.** A drum may be used to sharpen the execution of foot drill and rifle exercises at the halt, to beat the time for troops who are learning to judge correct timings and to beat the cadence.

50. **Metronome.** A metronome is an instrument that emits an audible sound and can be adjusted to indicate the cadence for various movements. It may be used by the instructor to establish and maintain the correct cadence. It is especially useful when used in conjunction with the drum. The accuracy of the metronome should be checked frequently with a watch.

51. **Pace Sticks.** A pace stick is used by a drill instructor or monitor to measure distance, interval and length of pace on the march (see Chapter 6).

INSPECTION

52. Inspections shall be carried out at the open order.

53. Ranks shall be dressed after completing the move to open order and before the inspection. They may also be dressed after moving to close order.

54. The inspecting officer or NCO will normally inspect the front and rear of each rank, commencing at the right flank of the front rank and proceeding in an anti-clockwise direction around each rank in turn. A supernumerary rank should normally not be inspected.

55. If a band is in attendance it may be inspected, though this is not usual unless it is an integral part of the unit on parade.

56. Ranks are inspected in the position of attention. Ranks not under inspection at the time may be ordered to stand at ease. Similarly, during the inspection of one unit or sub-unit, other units or sub-units not under inspection at the time may be ordered to stand at ease.

57. During an inspection, an individual ordered to adjust clothing or equipment shall do so immediately, maintaining position within the ranks. After the adjustment is finished, the position of attention will be resumed.

58. The inspection of an individual shall commence at the head and work down to the feet to ascertain that the service member:

- a. is properly equipped for the parade, with clothing and equipment clean and in good repair;
- b. is properly dressed, with all clothing, badges, ribbons, etc., worn correctly; and
- c. has high standards of personal hygiene and grooming, e.g., hair at correct length, shaved and washed.

FUNDAMENTALS OF FOOT DRILL

59. The individual who consistently maintains perfect balance on the completion of movements demonstrates:

- a. quick reflexes;
- b. steadiness;
- c. physical control of the body;

- d. mental alertness; and
- e. mastery of the basic skills.

60. Constant checking during all phases of training must be stressed to ensure the individual's attention to proper bearing.

BASIC SKILLS

61. The basic movements of foot drill are performed as follows:

a. **“Bend the ___ knee.”** One leg is kept braced with the foot firm and flat on the ground by applying pressure to the toe and the ball of the foot. The opposite knee is bent to the front of the body so that the toes hang directly below at a natural angle. The foot is raised 15 cm clear of the ground in quick time and during movements at the halt; the thigh is raised parallel to the ground for all movements executed in slow time (see also special procedures for foot drill on a floating vessel in Chapter 13).

b. **“Straighten the ___ leg.”** The leg is straightened to the ground by forcing the toe down so that the impact is taken on the ball of the foot.

c. **“Shoot the ___ foot forward.”** One leg is kept braced with the foot on the ground. The other foot is shot forward with the knee braced, ready to carry the weight of the body forward.

d. **“Shift the weight to the ___.”** Body weight is shifted by transferring the weight onto the ball of the foot being straightened to the ground and the balance is maintained by placing the foot flat and firm.

62. The phrase “Place the foot flat on the ground” means place the foot naturally on the ground without slapping or exaggeration.

SECTION 2

COMPLIMENTS

GENERAL

1. Compliments are formal marks of respect and courtesy, i.e., salutes.
2. The military salute is a traditional demonstration of trust and respect. Although the method of saluting varies with circumstances, the paying of compliments is a fundamental requirement that is indispensable to service discipline.
3. In Canada, military compliments are only paid to the Sovereign; the Governor General; members of the Royal Family; recognized foreign royalty; foreign heads of state or government; the Prime Minister; the Minister and Associate Minister of National Defence; lieutenant-governors; and commissioned officers. Exceptions, such as compliments paid to deceased service members, are as detailed in paragraphs 20 to 23 and paragraphs 25, 26, 28, 29 et 41.
4. Service individuals receiving a compliment shall acknowledge it.
5. Detailed instructions on the techniques of paying individual compliments are found elsewhere in this publication as follows:
 - a. at the halt – Chapter 2;
 - b. on the march – Chapter 3;
 - c. when bearing arms:
 - (1) rifle – Chapter 4,
 - (2) carbine – Chapter 5, and
 - (3) sword – Chapter 6;
 - d. when carrying pace stick or cane – Chapter 6.

FORMED MILITARY GROUPS

6. Compliments on behalf of a formed military group are normally given by the person in command of the group.
7. At the halt:
 - a. The person in command will order the group to attention before saluting.
 - b. When the group is armed, it shall be brought to attention and then may be brought to the shoulder arms position before the person in charge gives the appropriate salute.
8. On the march:
 - a. The person in charge of a formed military unit shall personally salute when passing junior officers (Captains and Lieutenants) superior to himself in rank. When passing senior officers superior to himself in rank, the person in charge shall order EYES RIGHT/LEFT and salute with the hand while turning head and eyes in the required direction.

- b. When bearing arms at the trail, the person in command shall shoulder arms before proceeding as detailed in subparagraph a. above.

INDIVIDUAL

9. Officers shall salute all officers of higher rank and shall return all compliments paid them. Senior officers receiving compliments from marching troops on a ceremonial parade shall hold the salute as each individual component passes directly by in review.
10. Non-commissioned members shall salute all commissioned officers.
11. Officers and non-commissioned members not part of a formed military group shall all pay individual compliments to an approaching higher ranking officer (see also paragraph 12). The senior officer receiving the salute shall return the compliment, while military persons accompanying that officer give an eyes right/left in the same manner as saluting without headdress (paragraph 15) during the exchange of compliments or greetings.
12. When an officer approaches a group of non-commissioned members, the senior of the group or the person who recognizes the officer first shall take command and call the group to attention: (GROUP, ATTENTION) the senior or person in charge shall then alone salute. Junior members shall draw their senior's attention to approaching officers if the circumstances require and allow.
13. Individual compliments to a formed military group on the march and under the command of an officer shall be paid by halting, turning to face the group and saluting. The salute should be maintained until the entire group has passed.
14. While bearing arms, individuals shall pay compliments to officers by saluting at the shoulder arms position. Sentries shall pay compliments in accordance with Chapter 10, Section 4.
15. When in uniform and not wearing headdress, compliments shall be paid by standing at attention. If on the march, arms shall be swung and the head turned to the left or right as required.

CIVILIAN DRESS

16. Appropriate compliments shall be paid when recognizing an officer dressed in civilian clothing.
17. When dressed in civilian clothes, all members shall stand at attention and male members (less Sikhs) shall remove headdress, on any occasion when a salute would be correct in uniform and extreme winter weather conditions allow. On the march, the headdress is raised or removed, if applicable, and the head turned right or left. When headdress is not worn, it is correct to turn the head as required and offer a polite greeting.

SPECIAL CIRCUMSTANCES

18. **Buildings.** Salutes are not given indoors in either public or service buildings except on parades, ceremonial occasions, in areas so designated by commanders, or when entering or leaving the office of an officer who should be paid compliments by virtue of his rank or appointment. Further:
 - a. it is correct to turn the head and offer a polite greeting when meeting an officer in the common area of a public or service building; and
 - b. it is not customary for those other than Sikhs working in a building to wear headdress when visiting another office in the same building. In this circumstance, compliments are paid by briefly coming to attention at the office door.
19. **Cenotaphs.** Officers and men shall salute individually and formed military groups shall pay compliments when passing the National War Memorial and cenotaphs to military dead.
20. **Colours.** Individuals and formed military groups shall pay compliments to uncased Colours, except when the Colour is part of an escort to the deceased during a funeral.

- a. Halted armed groups shall present arms.
- b. Military groups marching past uncased Colours shall give eyes right/left.
- c. See also paragraph 30.

21. **Religious Services and Buildings.** Conventional marks of respect and courtesy shall be observed during religious services and in places of worship, depending on the customs of the religion involved and the faith of the member (see A-DH-265-000/AG-001, CAF Dress Instructions, Chapter 2, Section 3 for further explanation).

22. **Funerals.** The following compliments shall be paid at state, military and civilian funerals:

- a. The remains of the deceased take seniority and alone receive compliments during a funeral.
- b. Members shall wear headdress and pay respects by saluting when passing the casket at a vigil.
- c. Formed military groups shall be halted and turned to face a passing funeral procession, and the officer or member in charge will salute the deceased while passing. Individual compliments shall be paid in a similar fashion.
- d. Individuals and formed military groups bearing arms shall salute a passing funeral procession by presenting arms.
- e. Salutes, as above, shall be accorded the casket during interments.
- f. At the end of a Service funeral, the officiating chaplain will proceed to the foot of the grave to pay his respects. Service members should then proceed to the foot of the grave, in order of seniority, to pay individual respects by saluting. When numbers warrant, members may approach in small informal groups.
- g. See also paragraph 25.

23. **Guards and Sentries.** Detailed instructions for paying compliments by guards and sentries are found in Chapter 10.

24. **Courtesy Salutes**

- a. Foreign officers shall be saluted in the same manner as Canadian Armed Forces officers and commissioned officers of the Royal Canadian Mounted Police, unless the circumstances clearly dictate otherwise.
- b. Service members may express their respect for individual civilians by using a salute as a formal means of greeting or farewell.
- c. Courtesy and protocols require the senior person to be on the right of a junior. Seniors participating in a event normally arrive last and depart first (see Battalion Ceremonial Chapter 9, sections 1 and 2).

25. **Funerals, Memorials and Commemorative Services.** Compliments to the dead shall be paid during the sounding of the calls "Last Post" and "Rouse" when they are used in funerals, memorial and commemorative services. (A Royal or General Salute will be ordered if appropriate). Compliments will commence on the first note and terminate on the last of each call when sounded. Compliments shall be paid as follows:

- a. All ranks who are not part of a formed military group shall salute.
- b. Formed military groups will be brought to attention and all officers shall salute.
- c. The funeral guard will present arms, while the escort will remain at the order, officers who are part of the escort will salute with the hand. In the latter case, the salute shall be held for the brief silent interval (10 second pause) between "Last Post" and "Rouse".

- d. During commemorative services, eg, Remembrance Day, compliments commence on the first note and terminate on the last note of each call when sounded, except for that weapons salutes shall be held through the silent interval between the "Last Post" and "Rouse"; and
- e. On defence establishments, all vehicles in the vicinity shall be stopped and the occupants shall alight dismount and pay compliments.

Note: interval between calls shall be 10 seconds for funerals, 1 minute for memorial services and 2 minutes for commemorative services

26. Lecture Rooms

- a. When a visiting officer or dignitary senior to the instructor enters a lecture room, theatre, etc., the instructor or senior member present shall call the group to attention (SQUAD or GROUP ATTENTION). All members of the class shall sit at attention, arms straight at the side, head and eyes to the front and heels together.
- b. Where it may be impracticable or hazardous to call the group to attention, the order, STAND FAST, will be given. Members of the group shall suspend all possible action, without causing physical danger to themselves or others, or damage to equipment, until the order CARRY ON is given.

27. Anthems and Salutes (see also paragraph 30). When the Royal Anthem, Royal Salute, Vice-Regal Salute, National Anthem (see A-AD-200-000/AG-000, Honours, Flags and The Heritage Structure of the Canadian Forces soon to become A-DH-200-000/AG-000; The Heritage Structure of the CAF) or the national anthem of a foreign country is played, all shall stand and:

- a. all ranks who are not part of a formed military group shall salute. The salute shall commence with the playing of the first note of music and shall be cut away at the end of the last note;
- b. formed military groups shall be called to attention and all officers and the NCMs or the person in charge shall salute; formed military groups bearing arms shall present arms;
- c. on defence establishments, all vehicles within hearing distance shall be stopped and the occupants shall dismount and pay compliments;
- d. anthems are not sung when played as part of a salute, or on a parade other than a church parade or remembrance or commemorative service/ceremony. If ordered to sing on a drumhead or remembrance ceremony, the parade will be brought to attention and all will join in the singing of the National Anthem. In this case officers do not salute.
- e. Sentries shall shoulder arms on hearing the national anthem unless in the vicinity of guards turned out to salute an important personage when they shall present arms in time with the guard. (see Chapter 10, Section 3, Para 16)
- f. at the discretion of the parade commander the National Anthem may be played at ceremonies such as graduations or changes of command. However, the National Anthem will not be played immediately preceding or following a general salute; and
- g. the Royal Anthem is not normally played during a ceremony (except as a Salute) or during a Remembrance ceremony.

28. National Flag. When the National Flag is hoisted or lowered at defence establishments, all ranks in or out of uniform within view shall face the flagpole or mast, stand at attention and pay compliments as follows:

- a. All who are not part of a formed military group shall salute.
- b. Unarmed military groups shall be halted facing the flagpole and the officer or non-commissioned member in charge of the group shall salute;
- c. Armed parties shall present arms.

- d. Motor vehicles in view shall be stopped and the occupants shall alight dismount and pay compliments.
- e. The same rules shall be followed during the raising and lowering of foreign flags

29. **Parades.** CAF members who are spectators at a parade shall:

- a. stand at the arrival and departure of a reviewing officer or dignitary. When troops on parade are armed, the signal to stand at the arrival shall be the parade commander's order to SHOULDER – ARMS. At the departure, all ranks will remain standing after the last Royal/General Salute until the reviewing officer or dignitary leaves the parade area;
- b. salute when uncased Colours pass directly in front of them. Guns are the Colours of formed artillery units and will be treated as such when they roll past in review on formal ceremonial parades;
- c. salute during the playing of National Anthems and Royal Salutes; and
- d. stand at attention during the playing of the General Salute.

30. **Personal Attendants.** Officers in personal attendance on a dignitary shall not salute during a Royal or General Salute to that dignitary or when a National Anthem is played as a salute for that dignitary. Those in personal attendance are defined as aides, equerries and the like closely accompanying a dignitary on a podium or parade, etc. Those personal attendants do not salute when their principals are saluted but should salute if their principals initiate the salute. eg, salute during a wreath laying.

31. **Reporting**

- a. When reporting to an officer or dignitary, the following procedure shall be observed:
 - (1) march forward, halt two paces in front of the officer or dignitary;
 - (2) salute, remain at attention, await acknowledgement;
 - (3) deliver the message, receive instructions, etc. (see subparagraph b. below);
 - (4) salute, await acknowledgement; and
 - (5) turn right and march off.
- b. At an investiture or when receiving a decoration, take one pace forward to receive the award and one pace back following the presentation.
- c. When a non-commissioned member reports to someone senior, other than an officer, the procedure outlined above shall be followed without the salute.

32. **Vehicles**

- a. Compliments shall be paid to passengers in staff cars bearing distinguishing flags or general officer car plates.

When wearing headdress, the senior passenger in a staff car and the passenger in the front seat of other vehicles shall salute. When not wearing headdress they shall return compliments by sitting at attention (see also A-DH-265-000/AG-001, CAF Dress Instructions, Chapter 2, Section 3, paragraph 12).

- b. Service personnel driving a vehicle, motorcycle or bicycle shall not salute or return a salute.
- c. Passengers riding in the rear of trucks shall pay compliments by sitting at attention.

33. **Other Occasions.** Compliments shall be paid on other occasions as notified from time to time in the appropriate regulations, orders and instructions.

MILITARY HONOURS AND GUN SALUTES

34. Further information on this subject is contained in A-AD-200-000/AG-000, Honours, Flags and **The Heritage Structure of the Canadian Forces** soon to become A-DH-200-000/AG-000; **The Heritage Structure of the CAF**.

35. Gun salutes are normally paid independent of other honours, and need not accompany or be accompanied by other honours.

36. Gun salutes shall normally commence at an appropriate time so as to terminate with the receiving dignitary's arrival in location.

37. If the location is one in which troops have been drawn up for review or a guard of honour has been mounted, the point of arrival is normally the podium.

38. When gun salutes and arms drill salutes are connected in the same ceremonial event, the event commander can coordinate the two, as well as the musical salute, for best effect. When circumstances prevent adequate warning of the dignitary's approach, it may be most effective to render the gun and arms drill salutes together. On these occasions, the gun salute shall normally commence on the final movement of the present arms, and the arms salute shall be concluded in the normal manner and the parade continued regardless of the fact that the gun salute may still be underway.

39. Gun salutes shall not be fired so as to cause aural discomfort to the receiving dignitary.

COMMISSIONED WARSHIPS AND BOATS

40. Service personnel shall salute when:

- a. boarding or leaving a commissioned warship; and
- b. mounting the quarter deck.

41. Compliments in boats shall be paid as follows:

- a. The officer in charge of a boat or the coxswain shall salute. One member of the boat's crew shall be detailed to salute if the design of the boat places the officer or coxswain in an inconspicuous position.
- b. In service whalers under oars, compliments are paid by giving the order OARS. One stroke after the order is given, the crew sit to attention with their oars horizontal and at right angles to the fore and aft line of the boat with blades feathered. In service boats under sail, the sheets are let fly. In service boats under power, engines are throttled down to idle and the propeller drive disengaged to take way off the boat.
- c. When a boat is alongside a landing place or accommodation ladder or is made fast, the boatkeepers shall sit to attention and the senior occupant shall salute. All passengers and crew who are not engaged in keeping the boat alongside shall:
 - (1) in a decked-in power boat, stand at attention facing the officer or dignitary being saluted; and
 - (2) in an open boat, sit at attention.
- d. Salutes shall not be exchanged when boats carrying officers of equal rank pass each other.
- e. All compliments paid by or in boats shall be discretionary having due regard to safe seamanship practices.

42. The Side shall be piped when the following personnel board Her Majesty's Canadian ships between the hours of colours and sunset:

- a. the Sovereign;
 - b. member of the Royal Family of equivalent rank of captain (N) or above when in naval uniform;
 - c. the Governor General of Canada and the Lieutenant-Governors of Provinces within their areas of responsibility;
 - d. Canadian and Commonwealth officers of the rank of commodore or Brigadier-General and above when in uniform;
 - e. all officers in uniform holding an appointment in command of a formation or group of ships, or an officer in command of a single ship;
 - f. members of a court martial attending or leaving the court;
 - g. the officer of the guard when flying his pennant;
 - h. all naval officers of other than Commonwealth nations in uniform at all hours; and
 - i. a body when being brought aboard or sent out of ship, at all times.
43. The Side is normally piped for an officer entitled to it even though accompanying an officer holding a senior rank or appointment who is not so entitled.

ANNEX A

DEFINITIONS

advance

A unit is advancing when it is moving in the direction the front rank would face in line. (action de couvrir)

alignment

A straight line on which a body of troops is formed or is to form.

appointment

Positions of command within units and sub-units, e.g., company commander, division commander or platoon commander.

battalion

A military formation consisting of two or more companies.

battery

An artillery formation approximately the size of a company.

brigade/air group

A military formation consisting of two or more battalions/wings and supporting formations. (brigade)

cadence

The number of beats to the minute. (cadence)

changing direction

To form a new front, i.e., to change the front of the unit, but not its formation, to face to the right or left.

close order

The normal distance (one pace) between ranks in line.

colours

- When used alone, or unless otherwise specified, Standards, Guidons, Queen's, and Command/College/Regimental Colours, and Air Squadron Standards.
- The English term "colours" is also used within Maritime Command to indicate the time (normally 0800 hours) when the National Flag and ships' ensigns are raised.

column

Sub-units one behind the other on parallel and successive alignments, at such a distance from one another that, when formed at an angle of 90 degrees to either flank, they will be brought into line with a seven-pace interval between platoons and a ten-pace interval between companies.

DEFINITIONS (CONT)

column close

A column with distance reduced to suit requirements, with a minimum distance of 12 paces between platoons and 15 paces between companies.

column of route

A unit turned to the right or left out of line, flank file leading, with officers and supernumeraries positioned to lead or follow the formation.

column of threes

A unit in threes turned to the right or left out of line, flank file leading, but with officers and supernumeraries in their normal positions as in line.

company

A military formation consisting of two or more platoons.

covering

The act of aligning one person or group directly in rear of another.

depth

The extent of ground occupied by a body of service personnel from front to rear.

distance

The space between service personnel or bodies of service personnel from front to rear.

division

- Two or more brigades.
- A sub-unit of a ship's company.
- A sub-unit of a guard of honour or of another guard. (division)

dressing

The act of taking up correct alignment and covering.

file, moving to a flank in

A unit in two ranks moving to a flank.

file, single

Service personnel, one behind the other on a frontage of one person.

DEFINITIONS (CONT)

file, blank

A blank file is the second single file from the left, when:

- in three ranks, this single file is without a centre and/or rear rank person; and
- in two ranks, this single file is without a rear rank person.

flank

Either side of a body of service personnel, as opposed to its front and rear. Designated as either the right or the left flank

flank, directing

The flank by which units march or dress.

flank, inner

The directing flank serving as a pivot when a body of service personnel changes direction.

flank, outer

The flank opposite the directing flank.

flight

A military formation approximately the size of a platoon.

form

The method of changing direction but not for-mation.

form squad

The method of changing formation but not direction.

front

The direction in which troops are facing or moving. (front)

frontage

The extent of ground covered laterally by a body of service personnel. As a general rule distances are 1.5 paces per file at the full arm dressing and 1 pace per file for all other intervals of dressing.

guides, right or left

Individuals on the right and left of the front rank, whose specific duties are to maintain correct distances, intervals from other units when on the march and on whom the remainder of the members in their unit march, take up and maintain dressing. The guides are not to be covered off (see 'covering'). Guides may be used to indicate unit and sub-unit parade square positions for fall-in.

DEFINITIONS (CONT)

incline

To face, and if on the march to move, in a direction of 45 degrees from the front to the indicated flank in a new direction.

interval

The space between individuals or bodies of service personnel on the same alignment.

line

Bodies of service personnel formed up on the same alignment.

marker

An individual placed to indicate the position which a body of service personnel will occupy when covering and falling in.

open order

A standard increased distance (two and one-half paces) between ranks in line.

pace

The length of a standard stride measured from heel to heel.

platoon

A basic military formation of approximately 30 service personnel, normally formed in three ranks, having a right marker, a platoon commander and a platoon warrant officer.

rank

A line of service personnel, side by side, on one alignment, separated by an interval.

rank, front

The rank which is leading when a unit is advancing.

rank, leading

The rank in front whether retiring or advancing.

rank, rear

The rank which is in the rear when the unit is advancing.

retiring

A unit is retiring when it is moving in the direction opposite to that which the front rank would face in line.

ship's company

The officers and crew of a ship.

DEFINITIONS (CONT)**standard pause**

The pause between movements of drill. The standard pause for drill at the halt is based on two beats of quick time. The standard pause for drill on the march is the period of time required to take two paces.

squad

A small military formation of less than platoon size which is adopted to teach drill movements.

squadron

A military formation approximately the size of a company.

sub-unit

One of the component bodies forming a unit; i.e., a platoon is a sub-unit of a company

supernumeraries

Officers who form in front of and warrant officers and senior non-commissioned officers who form in rear of their respective formations without filling a parade appointment.

troop

A military formation approximately the size of a platoon.

wheel

A movement by which a body of service personnel facing a flank changes direction without changing formation.

wing

A military formation approximately the size of a battalion.

CHAPTER 2

SQUAD DRILL AT THE HALT
WITHOUT ARMS

FORMATION OF A SQUAD

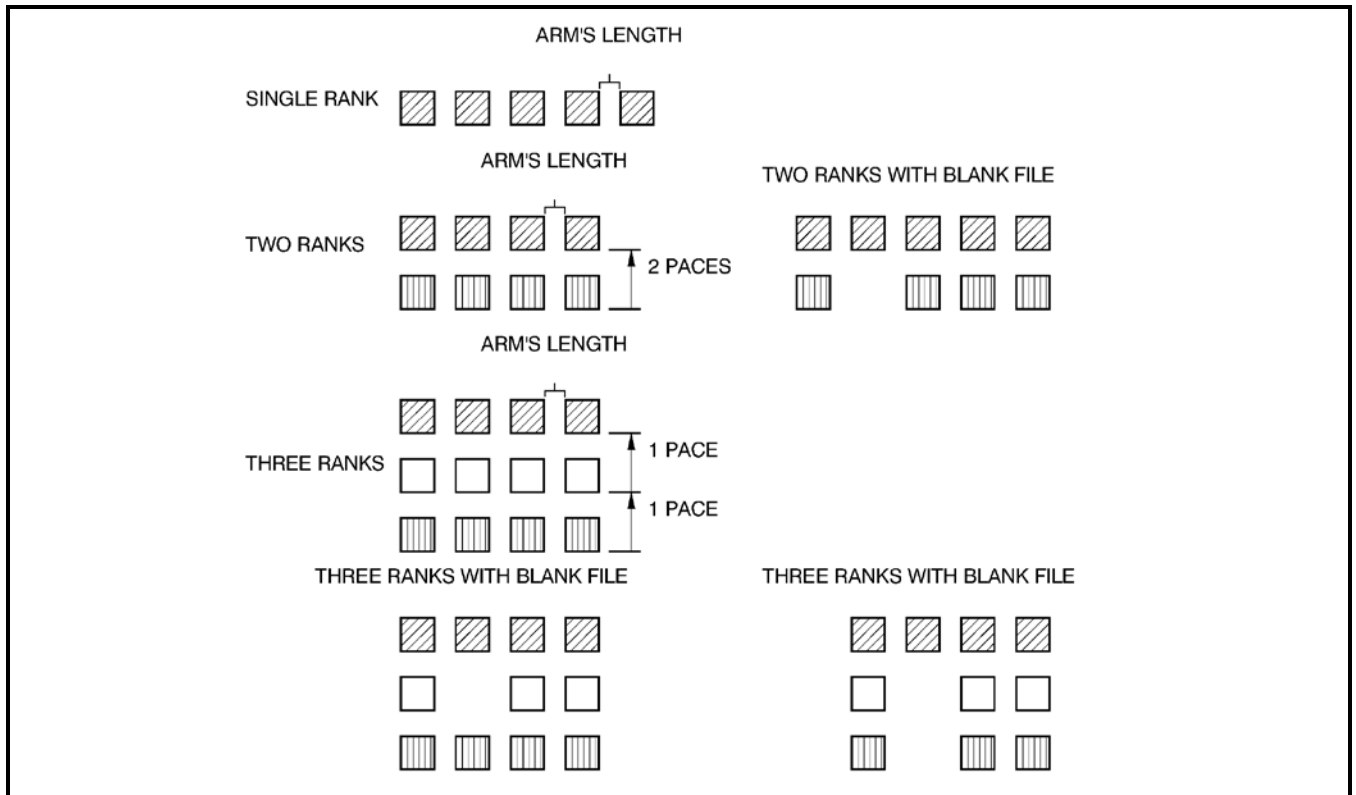

Figure 2-1 Squad Formations

1. As soon as practicable after arrival at the recruit training establishment, recruits shall be instructed on squad formations. These formations are essential to maintain control and ensure uniformity throughout recruit training.
2. On the command FORM UP IN SINGLE (TWO) (THREE) RANKS – MOVE, all persons so ordered will:
 - a. assume the position of attention;
 - b. observe the standard pause;
 - c. stepping off with the left foot, march forward towards the instructor; and
 - d. the first individual approaching the instructor will halt three paces directly in front, and the remainder will cover him and/or fall in on his left at arm's length intervals in accordance with Figure 2-1.
3. The instructor shall decide what formation to use. As a guide, a squad of:
 - a. five or fewer form a single rank;
 - b. six to nine form up in two ranks; and
 - c. ten or more form up in three ranks.

POSITION OF ATTENTION

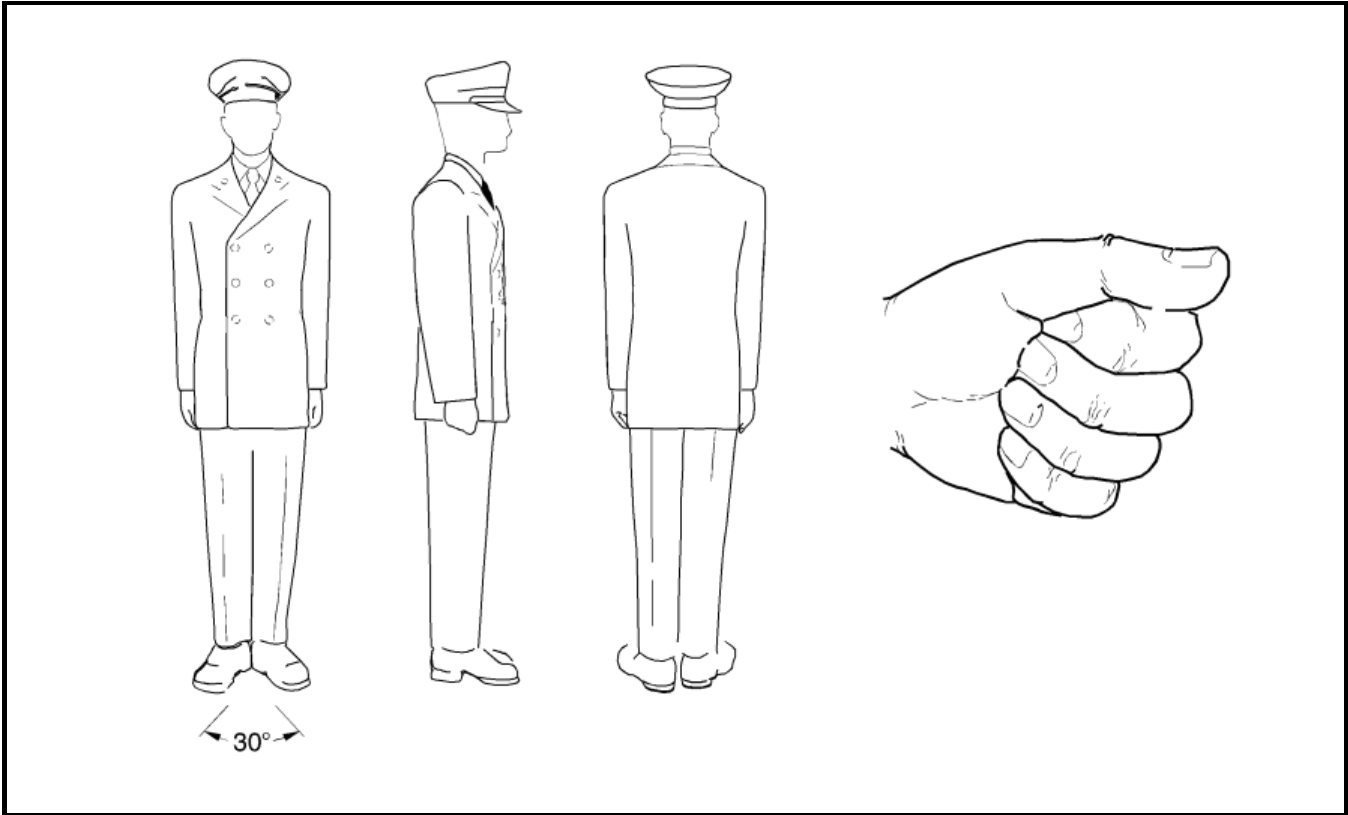

Figure 2-2 Position of Attention

4. The position of attention is one of readiness for a word of command. Alertness and exactness in this position is important, and therefore personnel should not be kept at attention longer than necessary.
5. The position of attention is the position adopted by all when addressing a superior.
6. The position of attention is as follows (Figure 2-2):
 - a. heels together and in line;
 - b. feet turned out to form an angle of 30 degrees;
 - c. body balanced and weight distributed evenly on both feet;
 - d. shoulders level, square to the front;
 - e. arms hanging as straight as their natural bend will allow, with elbows and wrists touching the body;
 - f. wrists straight, the back of the hands outwards;
 - g. fingers aligned, touching the palm of the hand, thumbs placed on the side of the forefinger at the middle joint with the thumbs and back of the fingers touching the thighs lightly and the thumbs in line with the seam of the trousers; and
 - h. head held erect, neck touching the back of the collar, eyes steady, looking their height and straight to the front.
7. No part of the body should be strained.

POSITION OF STAND AT EASE

8. The position of standing at ease is an intermediate position between attention and standing easy. It allows no relaxation but can be maintained without strain for a longer time than the position of attention.

STAND AT EASE FROM ATTENTION

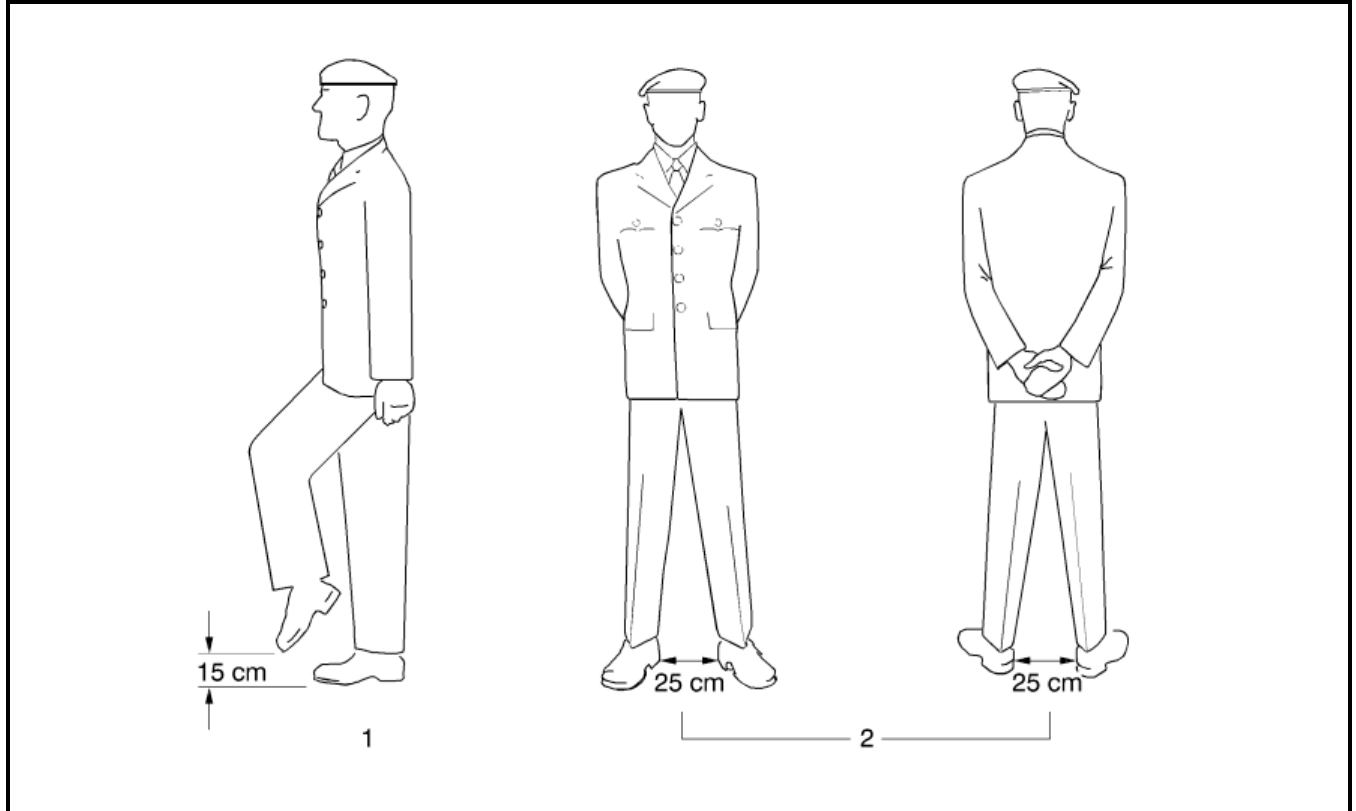

Figure 2-3 Position of Stand at Ease from Attention

9. On the command **STAND AT EASE BY NUMBERS, SQUAD – ONE**, squad members bend the left knee (Figure 2-3).
10. On the command **SQUAD – TWO**, squad members shall:
 - a. carry the left foot to the left, straightening it in double time, and place it smartly flat on the ground with the inside of the heels 25 cm apart;
 - b. simultaneously, with a quick motion, bring the arms behind the back, stretched to their full extent, and place the back of the right hand in the palm of the left, with thumbs crossed right over left, the fingers together and extended; and
 - c. balance the body with the weight evenly distributed on both feet.
11. On the command **STAND AT – EASE**, the two movements are combined.

STAND EASY

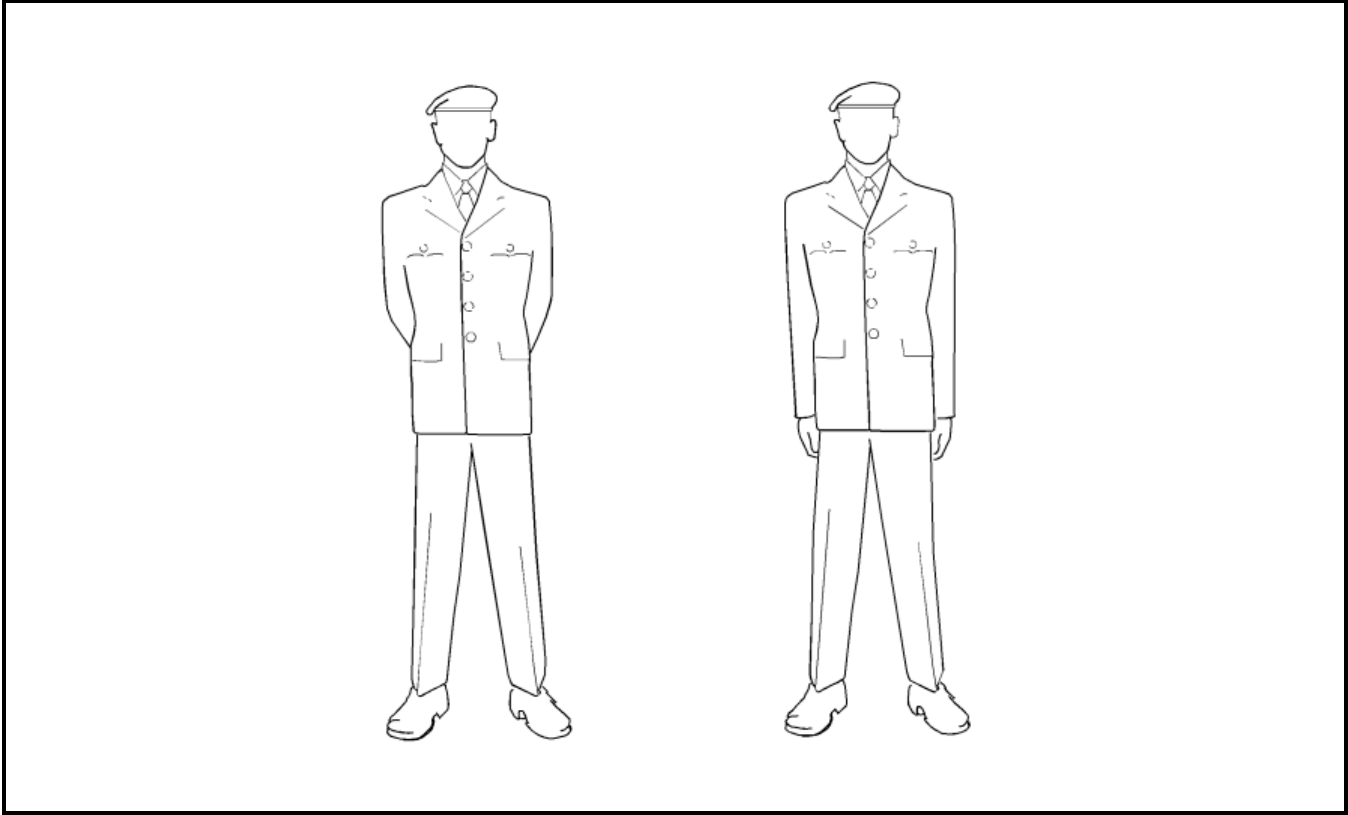

Figure 2-4 Position of Stand Easy

12. The position of stand easy is ordered when it is desirable to permit troops to relax. This command is only given when the squad is in the position of stand at ease.

13. On the command STAND – EASY, squad members shall (Figure 2-4):

- a. close the hands and bring the arms to the position of attention;
- b. observe a standard pause; and
- c. relax.

14. When standing easy, squad members may, with permission, move all but their feet and adjust clothing and equipment, but they shall not smoke or talk.

STAND AT EASE FROM STAND EASY

15. On the cautionary command SQUAD, squad members shall assume the position of stand at ease.

ATTENTION FROM STAND AT EASE

16. On the command ATTENTION BY NUMBERS, SQUAD – ONE, squad members shall bend the left knee and shift their balance to the right foot.

17. On the command SQUAD – TWO, squad members shall:

- a. straighten the left leg in double time, place the foot smartly on the ground, toe touching first, followed by the heel, and with heels aligned; and

b. simultaneously, with a quick motion, bring the arms and hands to the position of attention.

18. On the command ATTEN – TION, the two segments of the movements are combined as one.

CARRYING OF ARTICLES

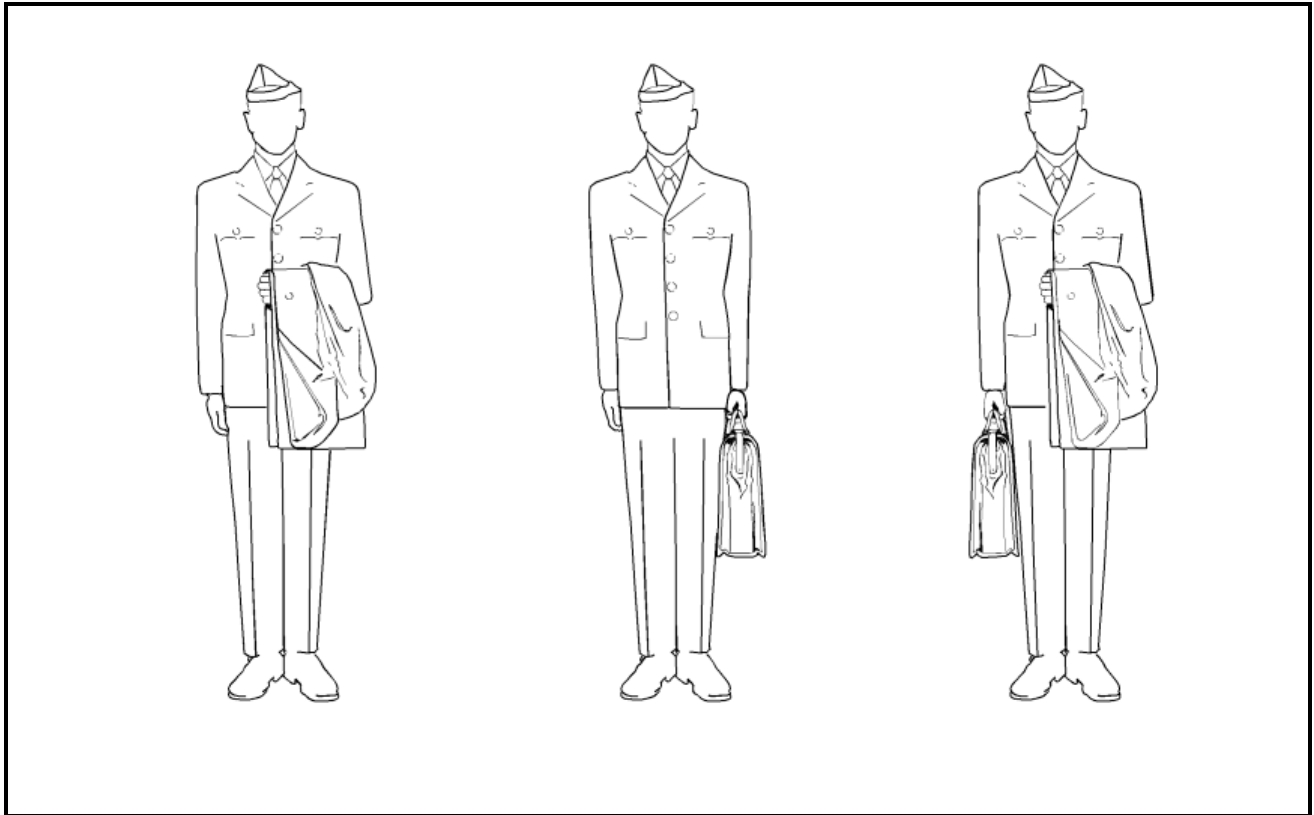

Figure 2- 5 Carrying of Articles

19. If any one article is carried, such as a briefcase, umbrella or raincoat, it shall be carried in the left hand. If an article is carried when marching, the left arm is not swung.

20. Articles shall be carried in the manner illustrated in Figure 2-5.

21. In all positions at the halt, the free arm shall be maintained at the side as for the position of attention.

REMOVE HEADDRESS

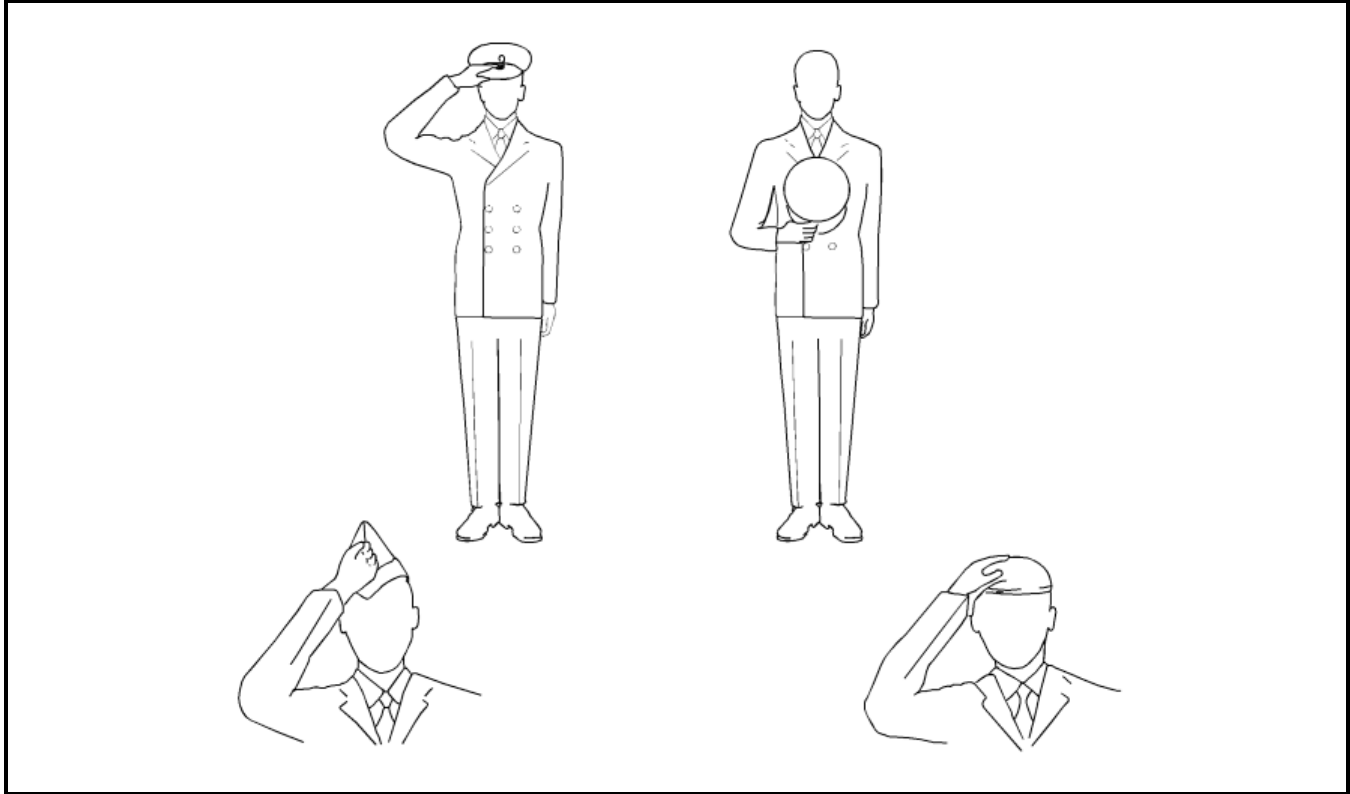

Figure 2-6 Remove Headdress

22. The order to remove headdress is customarily given on such occasions as outdoor church parades, during the consecration of colours and whenever it is desirable to honour a dignitary by giving three cheers. When ordered in connection with a religious event, it is optional for a CAF member to remove or not to remove his or her headdress for religious or spiritual reasons.

23. When ordered, all ranks on parade shall remove their headdress with the exception of:

- a. adherents of faiths for whom this is not permitted or acceptable (e.g., Sikhs);
- b. musicians when on parade with instruments;
- c. when ordered in connection with a religious event, it is optional for members to remove or retain his or her headdress in accordance with his or her belief.

24. On the command REMOVE HEADDRESS BY NUMBERS SQUAD – ONE, squad members shall bring the right hand to the front of the headdress by the shortest route and grasp it in the front between the thumb and fingers, with the fingers aligned and parallel to the shoulders as much as practicable (Figure 2-6).

25. On the command SQUAD – TWO, squad members shall maintain the bend in the right arm, cut the upper arm to the right side of the body and the forearm parallel to the ground, and bring the right hand to the centre of the body. Maintaining the grasp on the peak of the headdress, squad members shall hold the headdress above the hand and in the centre of the chest.

26. On the command REMOVE – HEADDRESS, the two movements are combined. The standard pause shall be observed between the movements.

27. When a unit is carrying arms, all action is carried out with the left hand when the command REMOVE – HEADDRESS is ordered.

28. Religious tenets, including those which are sexually based, shall be respected in a place of worship (see also A-DH-265-000/AG-001, CAF Dress Instructions).

STAND AT EASE WITH HEADDRESS REMOVED

29. On the command STAND AT – EASE, squad members shall assume the position for standing at ease when carrying articles, except that the right arm and hand will maintain the headdress in the position as detailed in paragraph 25.

STAND EASY WITH HEADDRESS REMOVED

Figure 2-7 Stand Easy with Headdress Removed

30. On the command STAND – EASY, squad members shall extend the right arm down the side with headdress held below the hand and, after a standard pause, relax (see Figure 2-7).

REPLACE HEADDRESS

31. On the command REPLACE HEADDRESS BY NUMBERS, SQUAD – ONE, squad members shall replace the headdress with the right hand. When wearing other than a service or wedge cap, two hands shall be used.

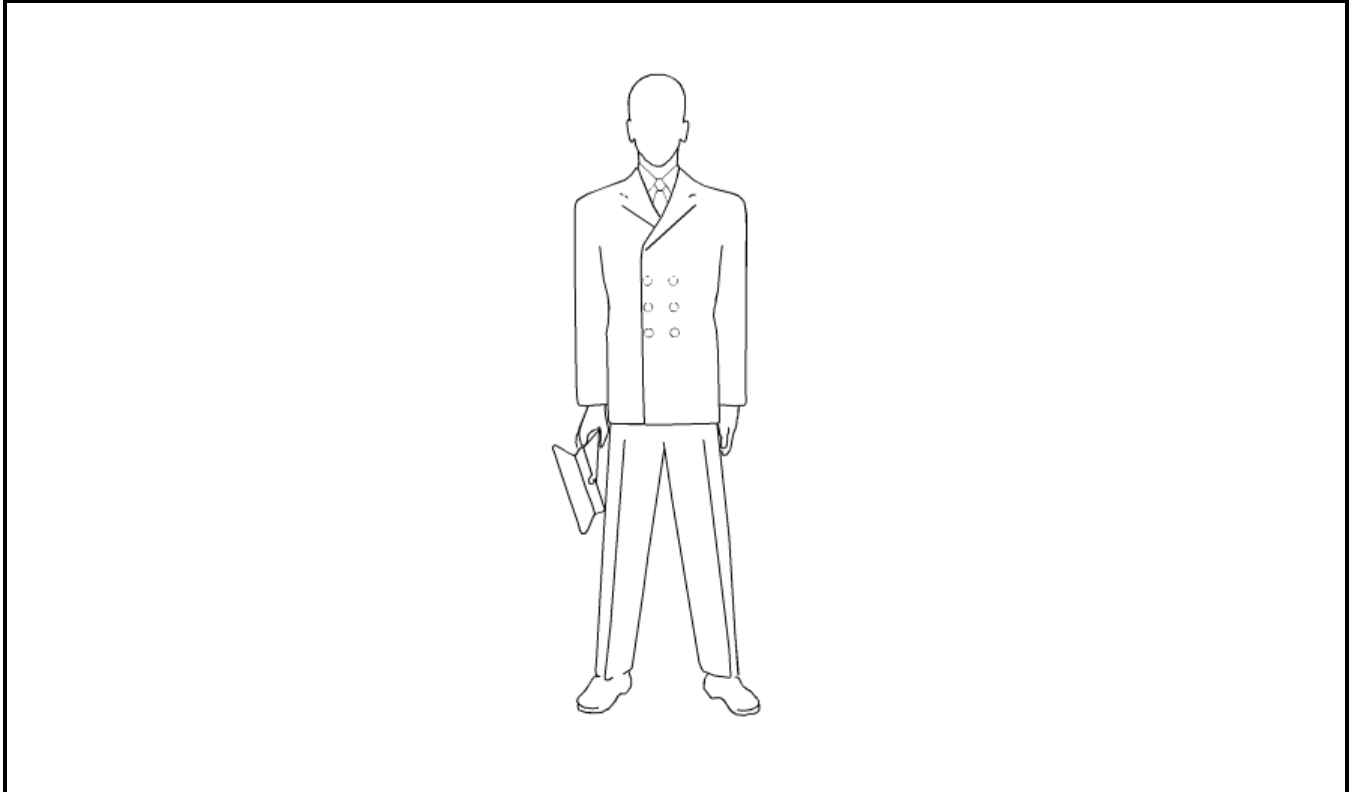
32. On the command SQUAD – TWO, resume the position of attention by cutting the right arm or arms to the side.

33. On the command REPLACE – HEADDRESS, the two movements are combined. The standard pause shall be observed between movements.

34. Once the headdress has been adjusted, the hand/hands remain at the head with the elbows towards to the body. Once ATTEN-TION is given, cut the arm/arms to the side (position of attention). If personnel carrying arms wearing headdress that requires the use of both hands to place it on the head, on the command REPLACE – HEADDRESS, the weapon shall first be placed between and gripped with the knees as for unfixed bayonets (Chapter 4), thus freeing both hands, after a standard pause, to complete the activity.

35. Officers carrying swords shall be ordered to return swords prior to removing headdress and shall draw swords upon the executive command ATTEN – TION following the command REPLACE – HEADDRESS, observing a standard pause between movements.

SALUTING, AT THE HALT, WITHOUT ARMS

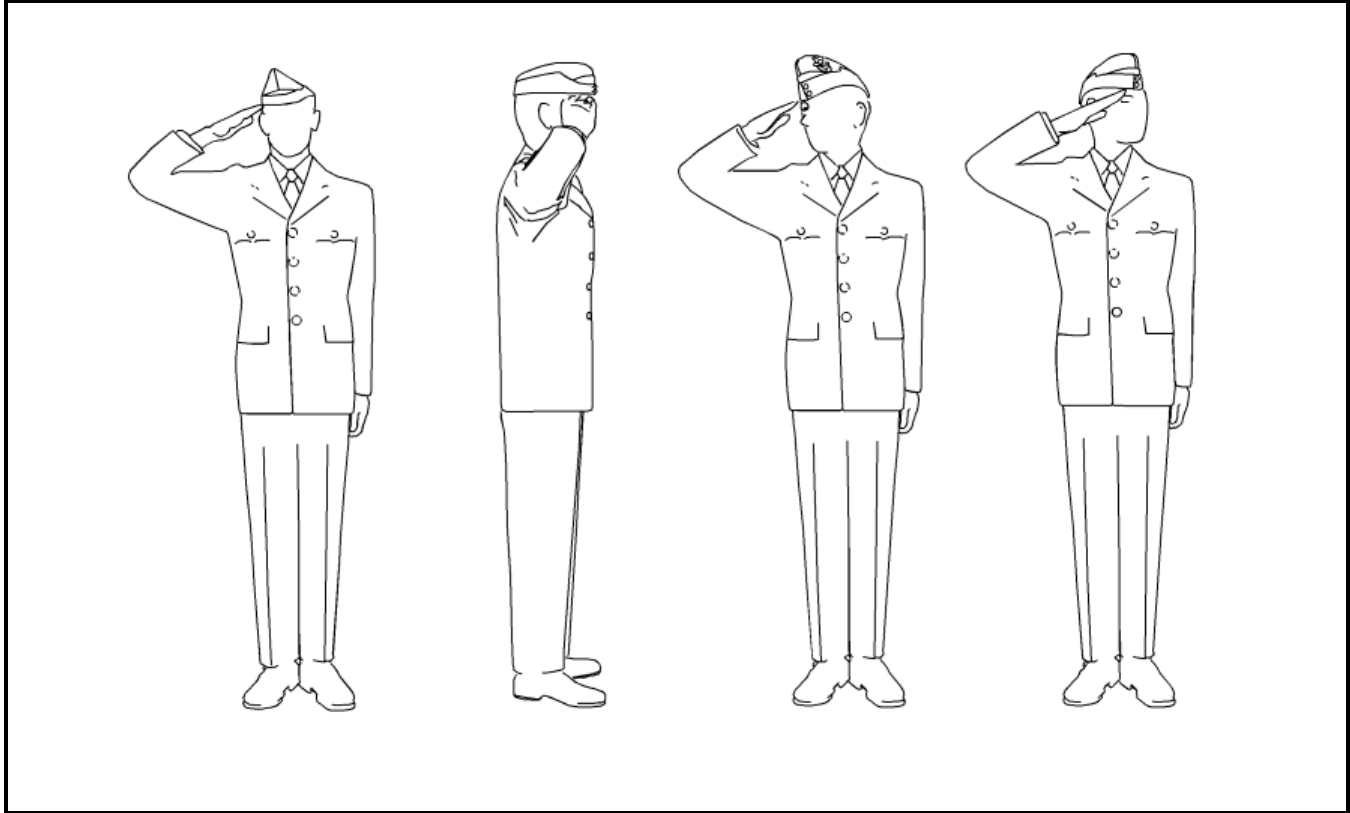

Figure 2-8 Saluting, at the Halt, without Arms

36. The salute is given with the right hand. When physical incapacity or carrying of articles makes a salute with the right hand impracticable, compliments will be paid by turning the head and eyes to the left or right or standing to attention, as appropriate (see also Chapter 1, Section 2).

37. On the command TO THE FRONT SALUTE BY NUMBERS, SQUAD – ONE, squad members shall:

- a. bend the right elbow and open the palm of the right hand as it passes the shoulder; and
- b. force the right hand by its shortest route to the front of the headdress (Figure 2-8) so that:
 - (1) the palm of the hand is facing down,
 - (2) the thumb and fingers are fully extended and close together,
 - (3) the tip of the second finger is in line with the outside of the right eyebrow and touching the outside edge of the headdress or arm of glasses, if worn,
 - (4) the hand, wrist and forearm are in a straight line and at a 45 degree angle to the upper arm,
 - (5) the elbow is in line with the shoulders, and
 - (6) the upper arm is parallel to the ground.

38. On the command SQUAD – TWO, the hand is brought sharply to the position of attention by the shortest route, without slapping the thigh. The hand is closed after the forearm is lowered below shoulder level.

39. On the command TO THE FRONT – SALUTE, the two movements are combined. The standard pause shall be observed between movements.

40. On the command TO THE RIGHT (LEFT) SALUTE BY NUMBERS, SQUAD – ONE, saluting shall be executed as detailed in paragraph 37, except that:

- a. the head and eyes shall be turned smartly to the right (left) as far as possible without straining;
- b. when saluting to the left, the right hand, wrist and arm are brought further over to the left to the correct position in line with the outside edge of the right eyebrow; and
- c. when saluting to the right, the arm is moved to the rear, with the tip of the second finger remaining in line with the outside edge of the right eyebrow.

41. On the command SQUAD – TWO, the hand is brought sharply to the position of attention, and simultaneously the head and eyes are turned smartly to the front.

42. On the command TO THE RIGHT (LEFT) – SALUTE, the two movements are combined. The standard pause shall be observed between movements.

43. When wearing headdress other than a cap with a peak, the second finger is 2 cm above and in line with the outer tip of the right eyebrow.

TURNING AND INCLINING AT THE HALT

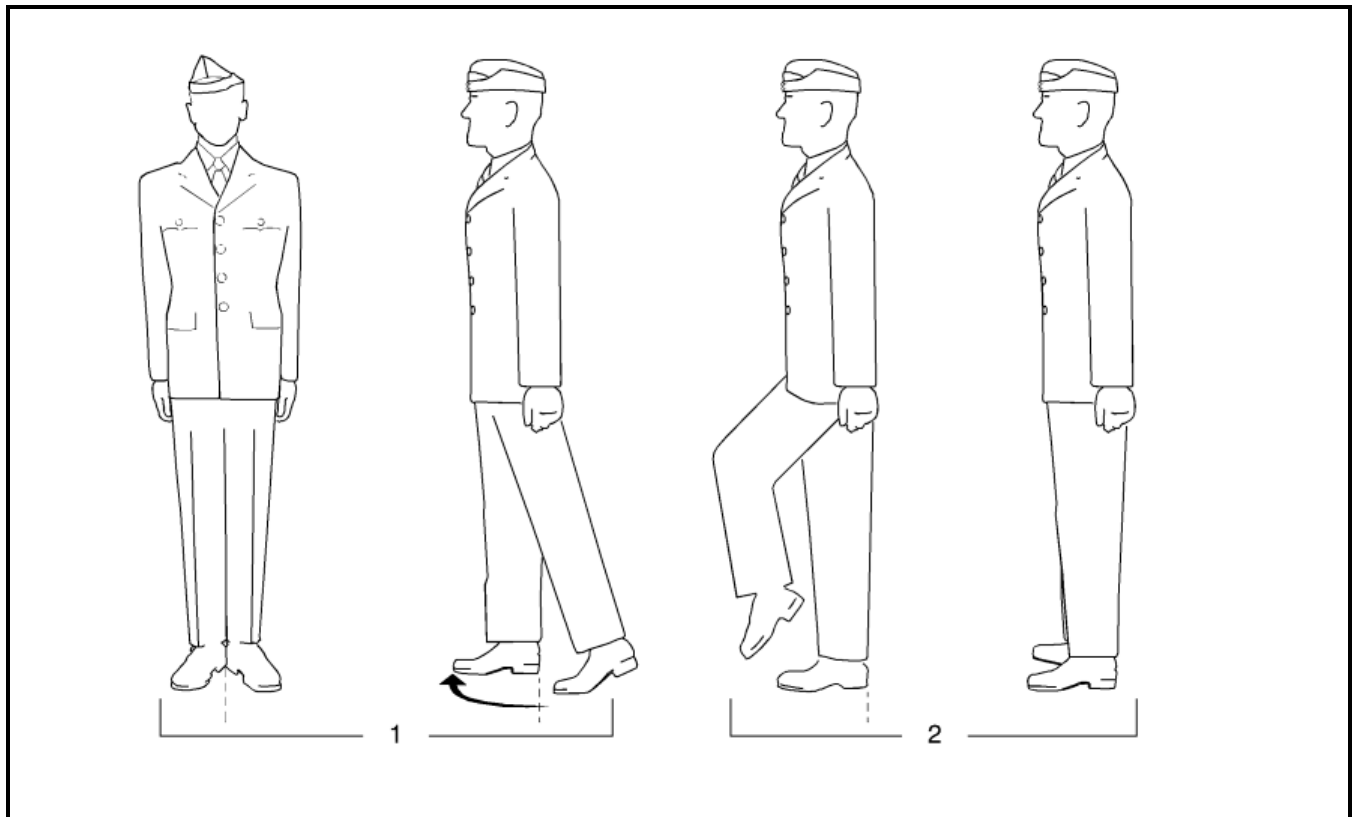

Figure 2-9 Right Turn

44. Turns and inclines are made to change direction: right or left turns change direction by 90 degrees, about turns by 180 degrees, and right and left inclines by 45 degrees.

45. On the command RIGHT TURN BY NUMBERS, SQUAD – ONE, squad members shall turn 90 degrees to the right by pivoting on the right heel and left toe and raising the left heel and right toe simultaneously. Both knees will be kept braced during the turn, arms at the sides and body erect. On the completion of the movement, the weight of the body is placed on the right foot and the left leg is braced with the heel off the ground as illustrated in Figure 2-9.

46. On the command SQUAD – TWO, squad members shall bend the left knee, straighten it in double time and smartly place the left foot beside the right to assume the position of attention.

47. On the command RIGHT – TURN, the two movements are combined. The standard pause shall be observed between the movements.

48. On the command RIGHT IN – CLINE, the drill as described for a right turn is followed, but the turn is only made through 45 degrees.

49. On the command LEFT – TURN, the drill as described for the right turn is followed, except that the details of moving the feet and direction are reversed.

50. On the command LEFT IN – CLINE, the drill as described for a left turn is followed, but the turn is only made through 45 degrees.

51. On the command ABOUT – TURN, the drill as described for the right turn is followed, except that the pivot to the right is made through 180 degrees. Balance is maintained by bracing the legs and locking the thighs (Figure 2-10).

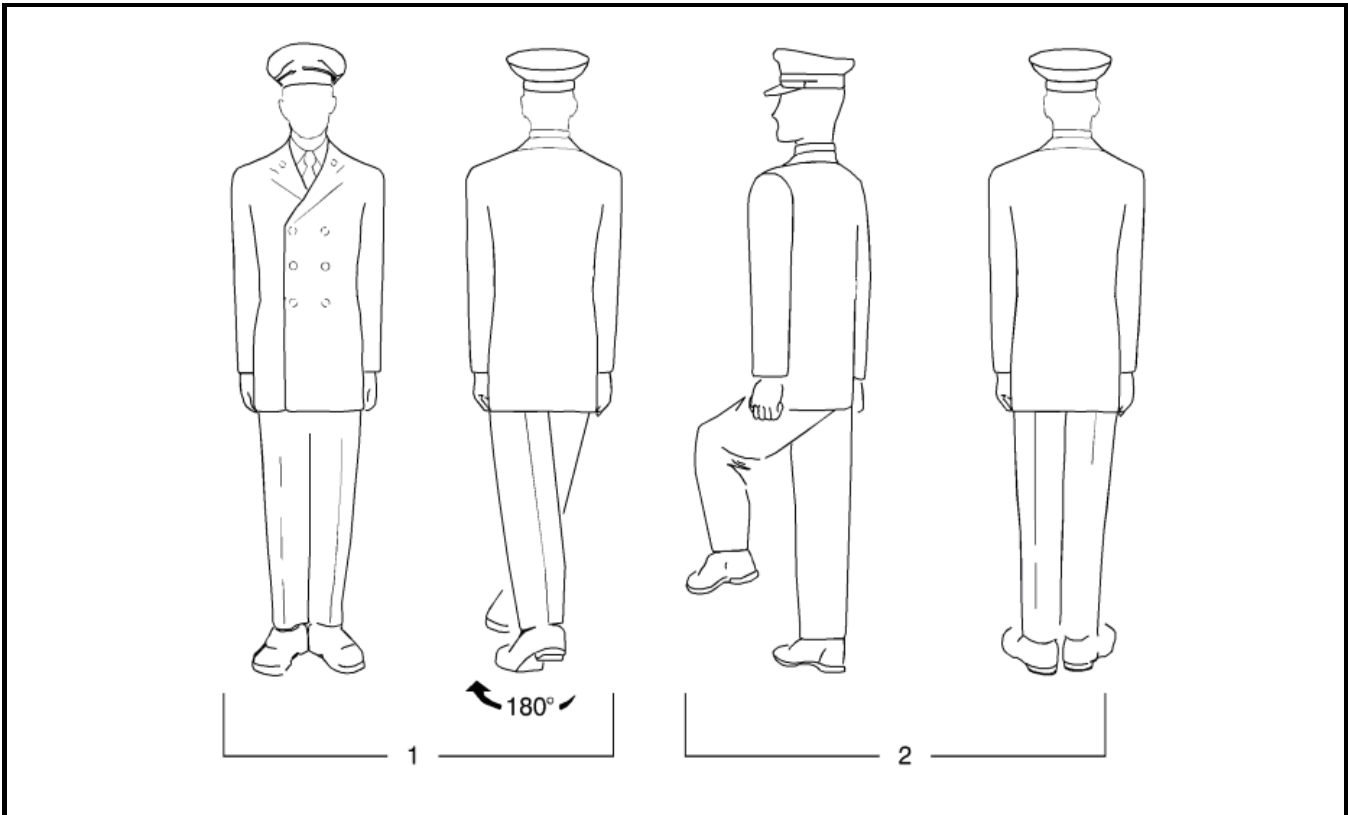

Figure 2- 10 About Turn

CLOSING TO THE RIGHT (LEFT)

52. Close march paces to the right (left) shall not be ordered when the distance required to move exceeds eight paces. When the distance is greater, the squad shall be turned and marched the required distance.

53. On the command ONE PACE RIGHT CLOSE MARCH BY NUMBERS, SQUAD – ONE, squad members shall:

- a. bend the right knee, carry the foot to the right and place it smartly on the ground with the inside of the heels one side pace 25 cm apart;

- b. balance the weight of the body evenly on both feet; and
 - c. keep the arms still at the sides.
54. On the command SQUAD – TWO, squad members shall shift the weight of the body to the right foot, bend the left knee and place the left foot smartly by the right to assume the position of attention.
55. On the command ONE PACE LEFT CLOSE MARCH BY NUMBERS, SQUAD – ONE, the drill as outlined above in paragraphs 53 and 54 is followed except that the details of moving the feet and the direction are reversed.
56. On the command ONE PACE RIGHT (LEFT) CLOSE – MARCH, the two movements are combined, observing the timing noted in paragraph 57.
57. The timings for the above movements are counted as follows:
- a. for one pace, “one-one”;
 - b. for two paces, “one-one, pause, one-two”;
 - c. for three paces, “one-one, pause, one-two, pause, one-three”; and
 - d. etc.

CALLING THE ROLL

58. On the command ATTEN – TION, ANSWER TO YOUR NAME, STAND AT – EASE, each squad member shall come to attention as his name is called and answer in one of the following ways:
- a. “Sir” or “Ma’am” if the person calling the roll is an officer or a chief warrant officer;
 - b. “Warrant” when the roll is called by a warrant officer;
 - c. “Sergeant”, “Master Corporal” or “Corporal” or equivalent when the roll is called by a member holding these ranks; or
 - d. “Present” if the person calling the roll is below the rank of Corporal.
59. When the roll-call is supervised by a person senior in rank to the person calling the roll, each squad member shall answer to his name with the correct response for the rank of the supervisor.
60. When a senior is in the ranks and the roll is called by a junior with no senior rank supervising the roll-call, both shall use the other’s rank title in calling and answering the name.
61. Each squad member shall stand at ease after answering his name.

NUMBERING

62. Numbering is used to:
- a. designate individuals in the squad; and
 - b. determine the number of persons on parade.
63. On the command SQUAD – NUMBER, the front rank only shall count off from right to left, the right-hand member calling out ONE and the next, TWO, and so on. The head and eyes remain still. There is no pause between numbers.

64. Each individual in the centre and rear rank takes the number of the front rank individual being covered.

65. When an error in numbering occurs, the command AS YOU WERE, may be ordered followed by the last correct number called out. The squad member so designated repeats his number and the numbering drill continues. If the command AS YOU WERE, SQUAD – NUMBER is ordered, the squad will renumber from the beginning.

PROVING

66. Proving is used to identify the flank man when the squad is being divided into several groups. It may also be used by members of the squad to identify themselves. It may be necessary to number the squad prior to proving.

67. On the command NUMBERS __, __, __ – PROVE, the members designated raise their left forearm parallel to the ground, keeping their left elbow close to the body and the hand closed as for the position of attention.

68. On the command ATTEN – TION, the members who proved adopt the position of attention.

PACES FORWARD AND TO THE REAR

69. When taking paces forward and to the rear:

- a. the cadence shall be in quick time;
- b. the length of each step shall be one half pace (35 cm); and
- c. the arms shall be kept still at the sides.

70. A group shall not be moved forward or back more than three paces by this method. When the distance is greater the squad will be marched the required distance.

71. On the command ONE PACE FORWARD MARCH BY NUMBERS, SQUAD – ONE, squad members shall:

- a. shoot the left foot forward one half pace, forcing the weight forward on the left foot, with the right heel raised; and
- b. keep the arms still at the sides.

72. On the command SQUAD – TWO, squad members shall bend the right knee, straighten it in double time, place the right foot smartly on the ground beside the left and assume the position of attention.

73. On the command ONE PACE FORWARD – MARCH, the movements are combined, observing the timing noted in paragraph 77.

74. On the command ONE PACE STEP BACK MARCH BY NUMBERS, SQUAD – ONE, squad members shall:

- a. shoot the left foot to the rear one half pace with the weight forward on the right foot and the left heel raised; and
- b. keep the arms still at the sides.

75. On the command SQUAD – TWO, squad members shall bend the right knee, straighten it in double time, place the right foot smartly on the ground beside the left, and assume the position of attention.

76. On the command ONE PACE(S) STEP BACK – MARCH, the two movements are combined, observing the timing noted in paragraph 77.

77. The timings for the above movements are counted as follows:

- a. for one pace, “one-two”;
- b. for two paces, “one, one-two”; and
- c. for three paces, “one, one, one-two”.

78. On the command TWO PACES FORWARD (STEP BACK) – MARCH, the movement shall be carried out as detailed above, except that the left foot shall be brought in to the right to assume the position of attention.

DRESSING A SQUAD

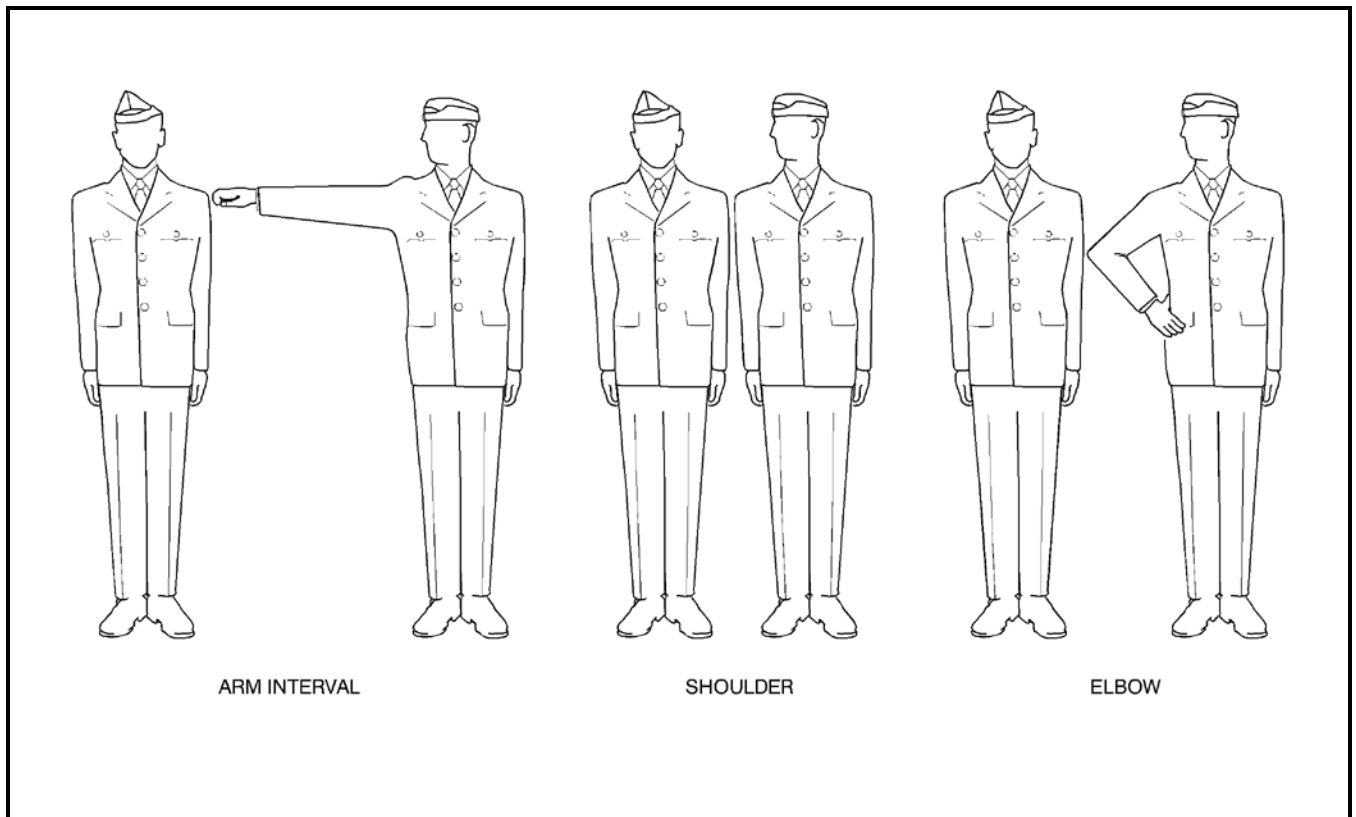

Figure 2- 11 Dressing a Squad

79. On the command RIGHT DRESS BY NUMBERS, SQUAD – ONE:

- a. the right-hand individual of the front rank stands fast; and
- b. the remainder take a half pace forward by shooting the left foot forward, bending the right knee and adopting the position of attention.

80. On the command SQUAD – TWO:

- a. the right file stands fast;
- b. the remainder turns head and eyes to the right as far as possible without straining; and

- c. simultaneously, the front rank, except the right-hand individual, shoots the right arm its full extent behind the shoulder of the one on the right. The hand is closed as in the position of attention, back of the hand uppermost and arm parallel to the ground.
81. On the command SQUAD – THREE:
- a. the right-hand individual of the front rank stands fast; and
 - b. the remainder takes up correct alignment, distance and covering by taking short, quick paces until they are in the correct position. Movement starts with the left foot (see Figure 2-11).
82. As a guide to taking up correct alignment, each member of the squad except those in the right file moves to a position from which the lower portion of the face of the second person to the right can just be seen. Correct covering is taken up by glancing to the front without moving the head. The interval is correct when the closed hand is touching the left shoulder of the person on the right.
83. On the command RIGHT – DRESS, the three movements are combined. The standard pause shall be observed between the movements.
84. On the command EYES – FRONT, squad members shall snap the head and eyes to the front and cut the right arm smartly to the rear of the individual on the right and to the position of attention without slapping the thigh.
85. On the command SHOULDER DRESSING, RIGHT – DRESS, dressing is carried out as for the right dress, except that the arms are not raised and dressing is taken up without arm's length interval. Enough lateral space is left between the shoulders of each person in the rank to manipulate weapons.
86. On the command ELBOW DRESSING, RIGHT – DRESS, dressing is carried out as for the right dress except:
- a. the right hand is placed on the hip or belt as applicable;
 - b. fingers closed, pointed down and extended forward;
 - c. thumbs to the rear; and
 - d. the point of the elbow forced forward and touching the individual's arm on the right.
87. When dressing by the left, the same drill is followed except the head and eyes are turned left and the left arm is raised. The left-hand individual stands fast, looks to the front, and those in the file behind adopt the appropriate distance between ranks.
88. Dressing may be ordered by the centre when required if more than one squad is on parade in line or mass. The command is INWARD – DRESS and flanking squads shall dress by their left or right as appropriate.
89. When a squad is formed with only one person in the blank file, that individual shall dress with the front rank when the squad is advancing and with the rear rank when the squad is retiring. When the squad is moving to a flank, the individual shall dress with the directing flank.
90. When bearing arms, dressing is completed by raising the left arm rather than the right arm.

OPEN ORDER MARCH

91. The open order is executed as follows:
- a. the front rank shall move forward three half paces, the rear rank shall step back three half paces and the centre rank shall stand fast;
 - b. the cadence shall be in quick time; and

c. the arms shall be kept still at the sides.

92. On the command OPEN ORDER – MARCH, the movements will be executed as for three half paces forward and to the rear, the final movement being executed by bending the right knee, straightening it in double time and placing the right foot smartly on the ground by the left and assuming the position of attention.

93. The timing for the movements is counted as one, one, one-two.

94. When formed in two ranks, the front rank stands fast and the rear rank steps back three half paces (see figures 2-12 and 2-13).

CLOSE ORDER MARCH

95. On the command CLOSE ORDER – MARCH, the squad shall reverse the movements in paragraphs 91 to 94.

ORDERING A SQUAD ON PARADE

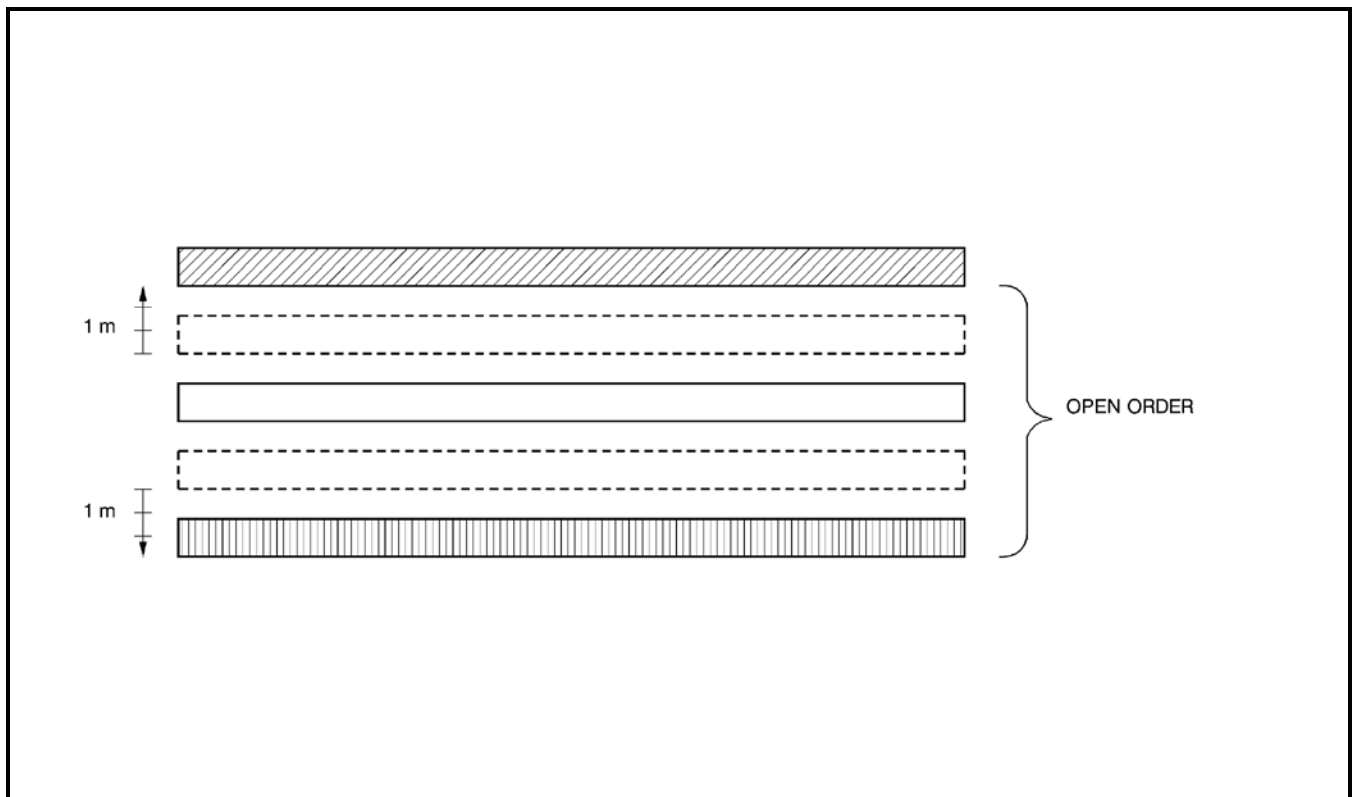

Figure 2- 12 Open Order – March (Three Ranks)

96. Prior to being fallen in on parade, the squad shall form itself up in three ranks at the edge of the parade ground and stand at ease. When the squad is formed up, the instructor may detail one person to act as marker, the marker shall then take up the position of the right-hand person of the front rank and stand at ease. If the instructor does not detail a marker, the right-hand person shall assume this duty. The instructor shall then proceed onto the parade ground and halt three paces in front of where he wishes the marker to fall in.

97. On the command MARKER, the person detailed as marker shall:

- a. come to attention and observe the standard pause;
- b. march in quick time to a position three paces in front of, and facing the instructor and halt; and
- c. remain at attention.

98. The instructor then turns right and marches to a position three paces in front and centre of where the squad will fall in.

99. On the command FALL – IN, squad members shall:

- a. come to attention;
- b. observe the standard pause;
- c. march onto the parade ground, and halt on the left of and covering off the marker; and
- d. remain at attention.

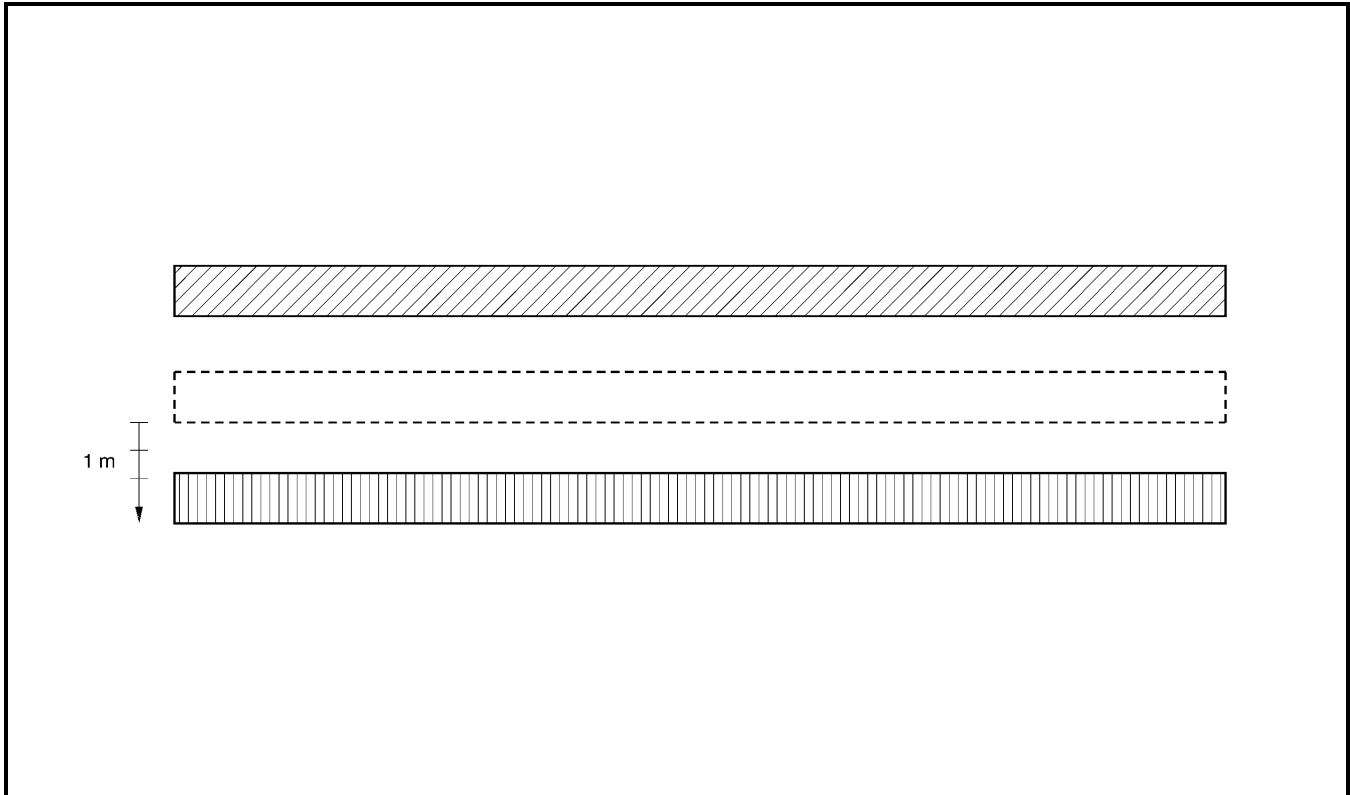

Figure 2- 13 Open Order – March (Two Ranks)

100. The instructor shall then proceed as required, e.g., OPEN ORDER – MARCH; RIGHT – DRESS; EYES – FRONT; and STAND AT – EASE.

DISMISSING A SQUAD

101. The command DIS – MISS signifies the end of a parade, period of instruction, etc. The squad shall be in line and at attention when dismissed.

102. On the command DIS – MISS, squad members shall:

- a. turn right;
- b. observe the standard pause;
- c. salute, if an officer is on parade;
- d. observe the standard pause; and

- e. march off independently, in quick time, from the place of parade.

FALLING OUT OF RANKS

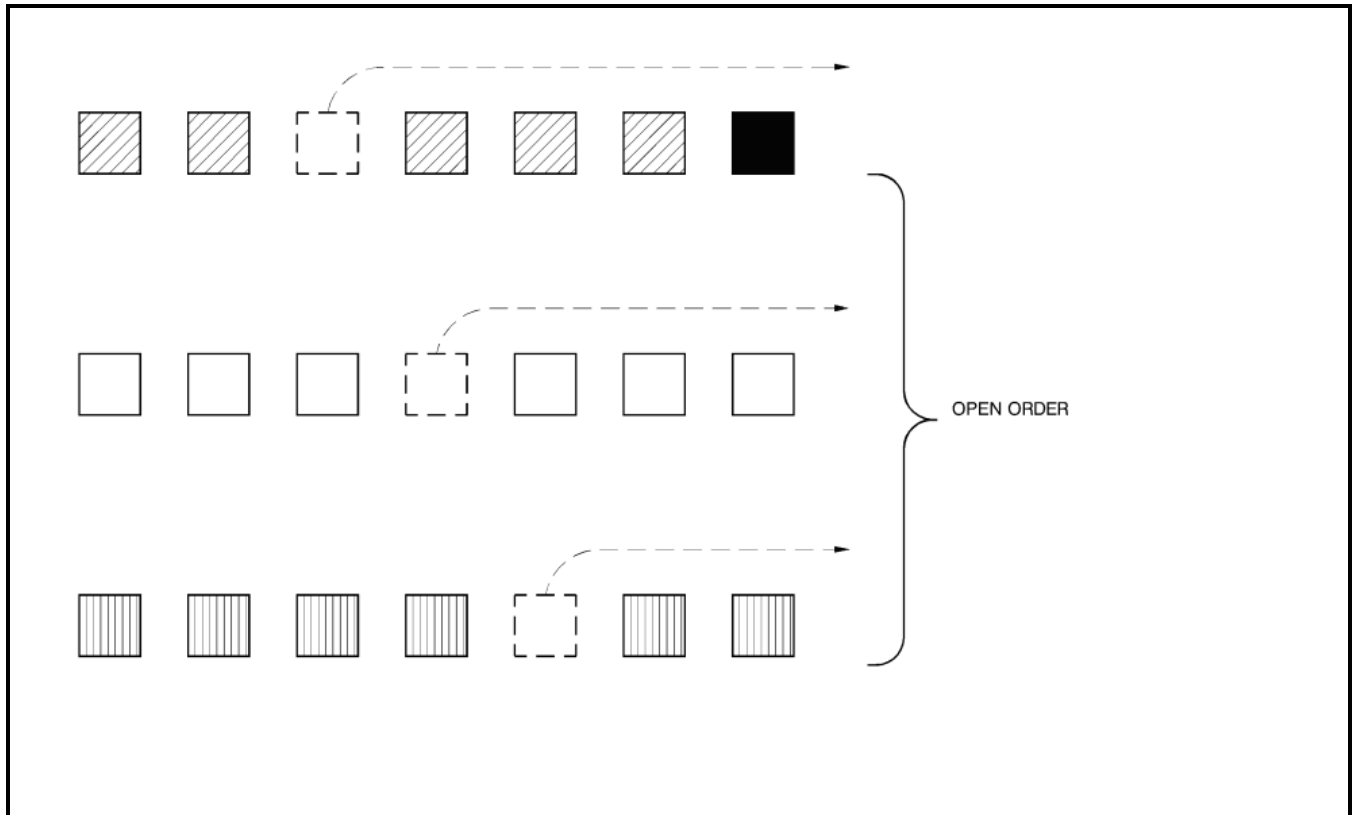

Figure 2- 14 Falling out of Individuals

103. The squad shall be at the open order when it is required to fall individuals out.
104. The command FALL – OUT shall be used when an individual is called out of the squad.
105. On the command FALL – OUT, the person ordered shall come to attention, and, after a standard pause, march, wheeling immediately, to the right flank of his rank and then proceed in the required direction, ensuring that he does not proceed in front of or with the ranks of another sub-unit (see Figure 2-14).

FALLING INDIVIDUALS IN

Figure 2- 15 Falling in of Individuals

106. On the command **FALL – IN**, the individual ordered marches to the left rank of the squad and returns to his position by marching in rear of his rank, wheeling into his original position and halting. The individual shall pick up his dressing and either remain at attention or stand at ease as required (see Figure 2-15).

SIZING IN THREE RANKS

107. A squad is sized to align individual member's heights for aesthetic balance and give the best general impression to a spectator.

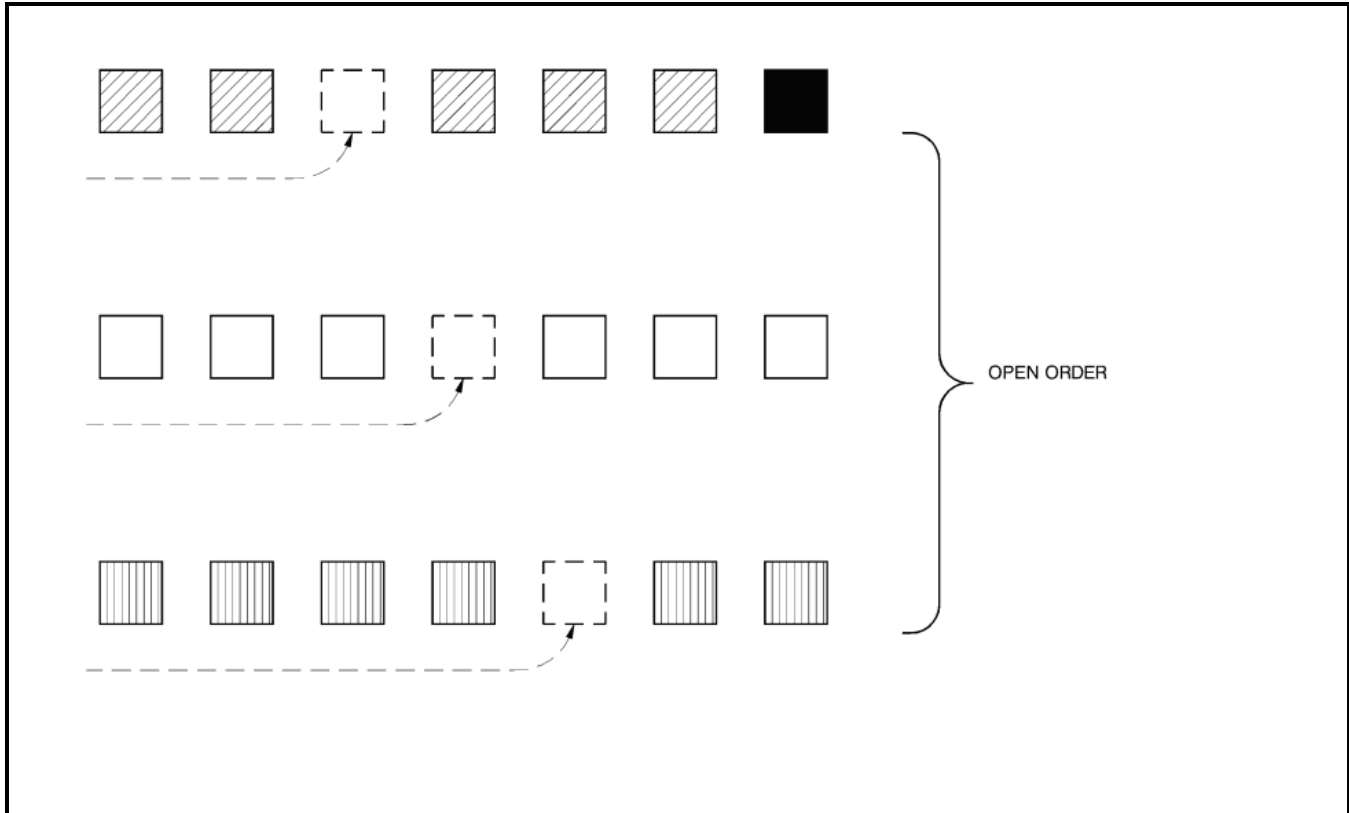
108. On the command **TALLEST ON THE RIGHT, SHORTEST ON THE LEFT, IN THREE RANKS – SIZE**, the squad shall turn right, observe the standard pause, then arrange themselves according to height, with tallest on the right and shortest on the left in three ranks, shoulder to shoulder dressing and covering off front to rear.

109. The instructor shall give the commands **OPEN ORDER – MARCH**; and **SQUAD – NUMBER**.

110. On the command **EVEN NUMBERS ONE PACE STEP BACK – MARCH**, the even numbers shall step back one half pace.

111. On the command **NUMBER ONES STAND FAST; ODD NUMBERS RIGHT, EVEN NUMBERS LEFT – TURN**, the squad shall act as ordered.

112. On the command **REFORM THREES, QUICK – MARCH** (Figure 2-16):

- a. the right file shall stand fast;
- b. the remainder of the odd numbers shall march forward and form up on the left of the number one of each rank;

- c. the even numbers of each rank shall wheel around to the right and follow the odd numbers of their respective rank; and
- d. when each member arrives in his new position, he shall halt at arm's-length interval, observe the standard pause, turn left and remain at attention.

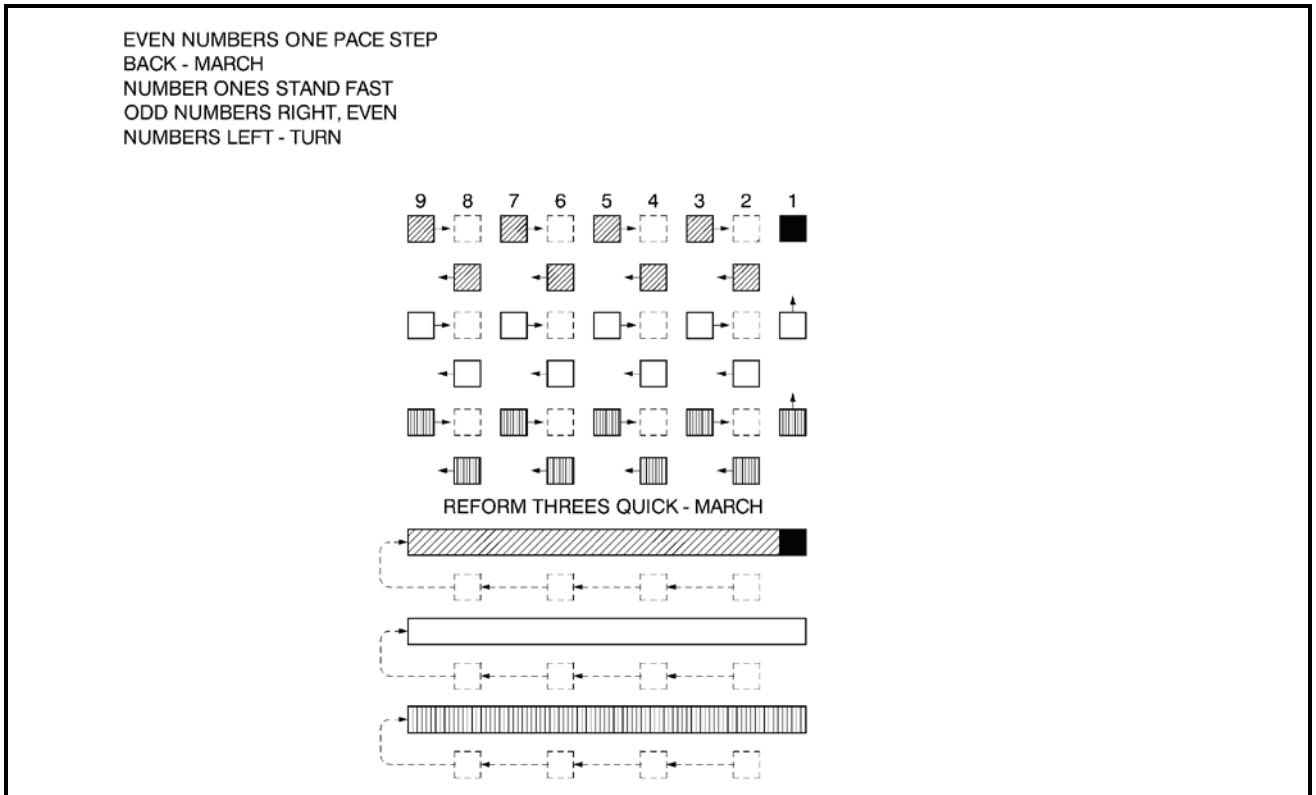

Figure 2- 16 Sizing in Three Ranks

SIZING IN TWO RANKS AND REFORMING THREES

113. On the command TALLEST ON THE RIGHT, SHORTEST ON THE LEFT, IN TWO RANKS – SIZE, the squad shall turn right, observe the standard pause, then arrange themselves according to height, with tallest on the right and shortest on the left in two ranks, shoulder to shoulder dressing and covering off front to rear.
114. On the command MARKER STAND FAST, FRONT RANK RIGHT, REAR RANK LEFT – TURN, the ranks shall act as ordered.
115. On the command REFORM THREES, QUICK – MARCH, the squad reforms three ranks as follows:
 - a. the marker remains the right-hand person of the front rank;
 - b. the second member of the front rank becomes the right-hand person of the centre rank;
 - c. the third member of the front rank becomes the right-hand person of the rear rank;
 - d. the rear rank wheels right following the front rank and as each member closes up towards his new position, he shall follow the procedure as detailed in subparagraphs a., b. and c; and
 - e. when each member arrives in his new position, he shall halt at arm's-length interval, observe the standard pause, turn left and remain at attention.

SIZING IN SINGLE RANK AND REFORMING THREES

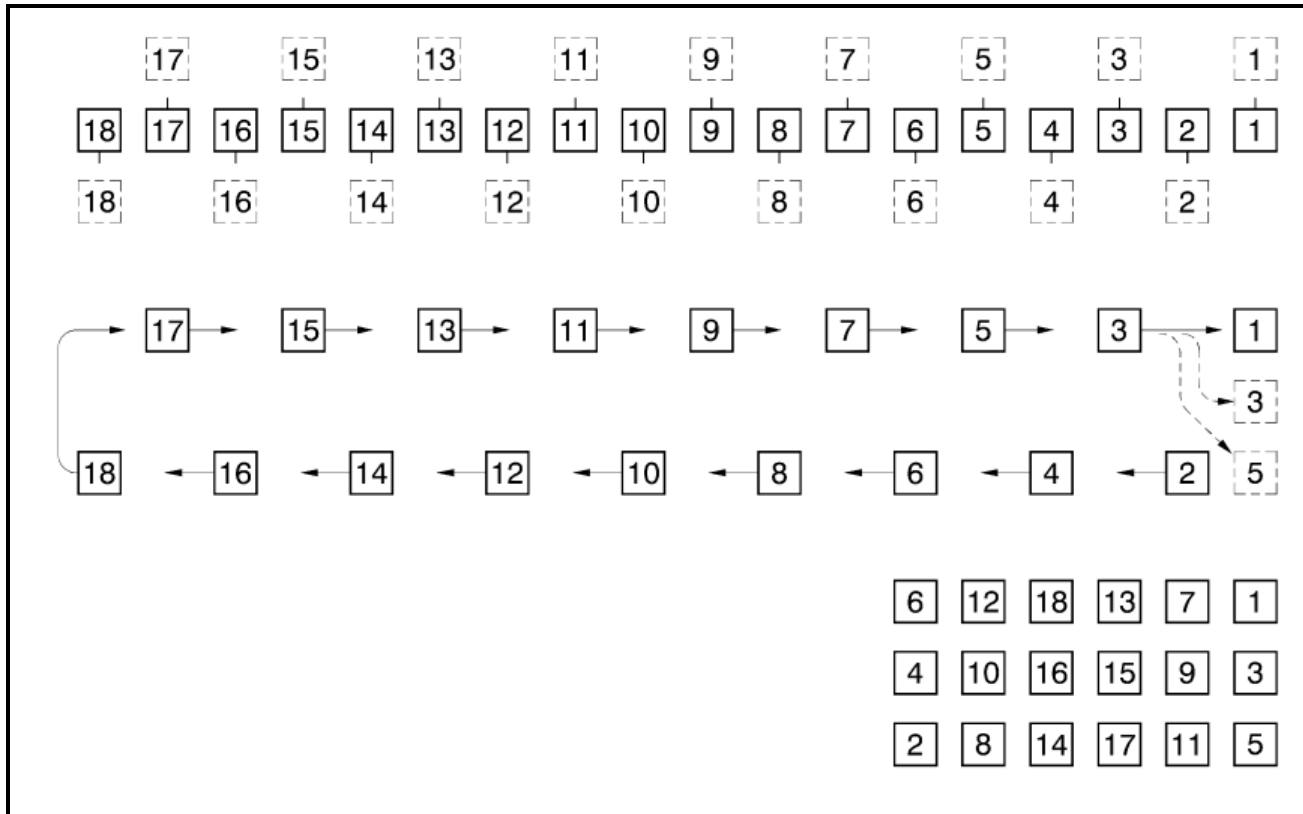

Figure 2- 17 Sizing in Single Rank

116. On the command TALLEST ON THE RIGHT, SHORTEST ON THE LEFT, IN A SINGLE RANK – SIZE, the squad shall turn right, observe the standard pause, then arrange themselves according to height, with tallest on the right and shortest on the left in one single rank, shoulder to shoulder dressing and covering off front to rear.

117. On the command SQUAD – NUMBER, the squad shall act as ordered.

118. On the command ODD NUMBERS ONE PACE FORWARD, EVEN NUMBERS ONE PACE STEP BACK – MARCH, the squad shall act as ordered.

119. On the command NUMBER ONE STAND FAST, ODD NUMBERS RIGHT, EVEN NUMBERS LEFT – TURN, the squad shall act as ordered.

120. On the command REFORM THREES, QUICK – MARCH, the squad reforms three ranks (Figure 2-17) as follows:

- a. number one remains the right-hand person of the front rank;
- b. number three becomes the right-hand person in the centre rank;
- c. number five becomes the right-hand person in the rear rank, and so on; and
- d. when each person arrives in his new position, he shall halt, at arm’s-length interval, observe the standard pause, turn left and remain at attention.

FORMING TWO RANKS FROM THREE

121. Prior to forming two ranks from three ranks, the squad shall be in close order, dressed at arm’s length interval and numbered.

122. On the command FORM TWO RANKS BY NUMBERS, SQUAD – ONE, the centre rank takes one pace left.

123. On the command SQUAD – TWO:

- a. the odd numbers of the centre rank take two half paces forward toward the front rank and assume the position of attention; and
- b. the even numbers of the centre rank take two half paces to the rear into the rear rank and assume the position of attention.

124. On the command FORM TWO – RANKS, the two movements are combined. A standard pause shall be observed between the movements.

125. After forming two ranks, the squad shall be dressed.

126. When there is a blank file, the left-hand person of the centre rank moves in the opposite direction to that indicated. An exception occurs in the case of a one-person blank file and an even numbered frontage. In this case, the left-hand person of the centre rank acts according to the standard rule.

REFORMING THREE RANKS FROM TWO

127. Prior to reforming three ranks, the squad shall be in close order.

128. On the command REFORM THREE RANKS BY NUMBERS, SQUAD – ONE:

- a. the original odd numbers of the centre rank take two half paces to the rear; and
- b. the original even numbers of the centre rank take two half paces forward.

129. On the command SQUAD – TWO, the centre rank takes one half pace right close march.

130. On the command REFORM THREE – RANKS, the two movements are combined. A standard pause shall be observed between the movements.

131. After reforming three ranks the squad shall be dressed.

FORMING FOUR OR MORE RANKS

132. If required, squads may be formed into more than three ranks. For a single squad, this is most simply done when originally assembled. For more than one squad, a single multiple-ranked formation can be assembled by ordering squads together.

133. Common multiple-ranked formations are those with six, nine and twelve ranks.

134. The number of ranks formed shall normally be greater than the number of files.

CHAPTER 3
SQUAD DRILL ON THE MARCH
WITHOUT ARMS

FUNDAMENTALS

1. The Canadian Armed Forces (CAF) march and manoeuvre on foot in quick, slow and double time at the cadences and pace lengths described in paragraphs 5 to 8.
2. The quick march can be maintained for long periods of time and is the standard for routine duty.
3. The slow march is derived from the normal cadence used by former soldiers, who had to manoeuvre over uneven battlefields, and from formal parade steps. The slow march is now used only on ceremonial occasions and its style has evolved slightly to emphasize dignity and stateliness.
4. Double time is used to move troops rapidly from one point to another.

PACE LENGTH AND CADENCES

5. The standard lengths of pace are:
 - a. quick and slow time – 75 cm;
 - b. stepping out in quick and slow time – 85 cm;
 - c. stepping short in quick time and slow time – 55 cm;
 - d. double time – 1 m;
 - e. half pace in quick time (used for marching forward and back three paces or less, see Chapter 2, paragraphs 69 and 70) – 35 cm; and
 - f. side pace – 25 cm.
6. When marching the cadence is:
 - a. in quick time, 120 paces per minute;
 - b. in slow time, 60 paces per minute;
 - c. in double time, 180 paces per minute;
 - d. for extended funeral processions, 75 paces per minute (a faster slow march); and
7. During recruit training, the cadence in quick time may be increased to 140 paces per minute to encourage agility and alertness.
8. All units shall practice and be prepared to march and manoeuvre with other elements of the CAF at the standard cadences. However, two other traditional quick march cadences may be ordered by parade commanders of units parading alone or with others units sharing these customs:
 - a. for foot guards regiments on their own parades, 116 paces per minute.
 - b. for Scottish/Highland regiments on their own parades, 110 paces per minute; **and**

- c. for light infantry (less Princess Patricia's Canadian Light Infantry, which drills as a line regiment) and rifle regiments, which have traditions of maintaining special agility and alertness on the battlefield, 140 paces per minute on their own parades;

WORDS OF COMMAND

9. Except for certain commands used in sentry drill, all commands to commence marching are given when personnel are at the position of attention.

10. On the march, executive commands are given as the foot, specified in the following list, is forward and on the ground, unless otherwise directed:

Word of Command	Foot
HALT (except when marching in slow time, when the command will be given "on the right foot")	left
STEP OUT, or STEP SHORT	left
CHANGE TO QUICK (SLOW or DOUBLE) TIME	right
MARK TIME (when marching)	right
FORWARD	left
ABOUT TURN	right
RIGHT TURN, RIGHT INCLINE, RIGHT FORM, or ON THE RIGHT FORM SQUAD	left
LEFT TURN, LEFT INCLINE, LEFT FORM, or ON THE LEFT FORM SQUAD	right
CHANGE STEP	right
SALUTE (on the march)	left
EYES RIGHT, or EYES FRONT	left
FORM SINGLE FILE (on the march)	right
REFORM RANKS FROM SINGLE FILE (on the march)	right

11. As illustrated in Figure 3-1, unless the directing flank is changed for a special movement, it is always:
 - a. when advancing in line, the right flank;
 - b. when retiring in line, the left flank; and
 - c. when in threes, the original front rank, i.e., when moving to the right flank, the dressing is by the left; when moving to the left flank, the dressing is by the right.

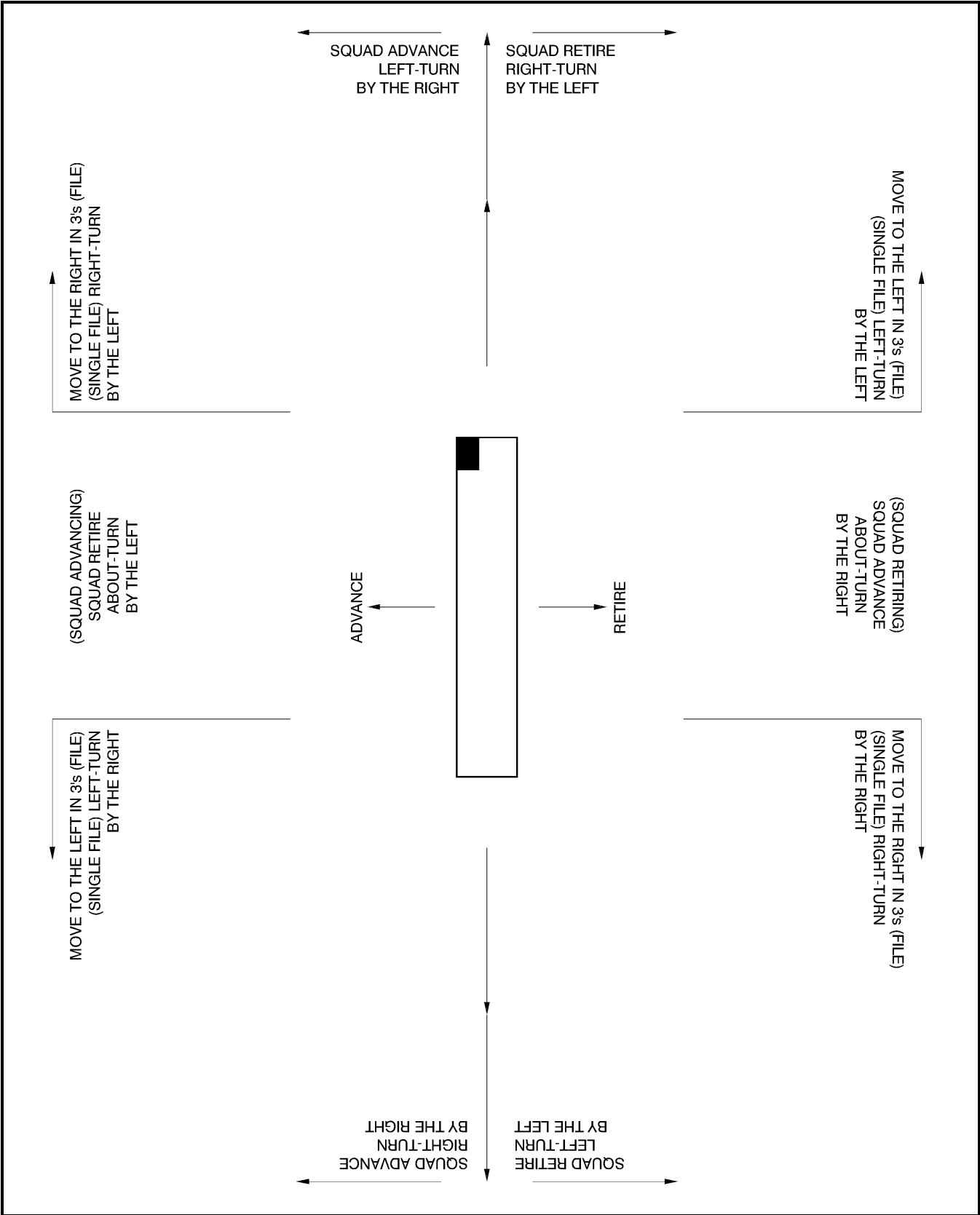

Figure 3-1 Advance/Retire and Directing Flanks

MARCHING AND HALTING IN QUICK TIME

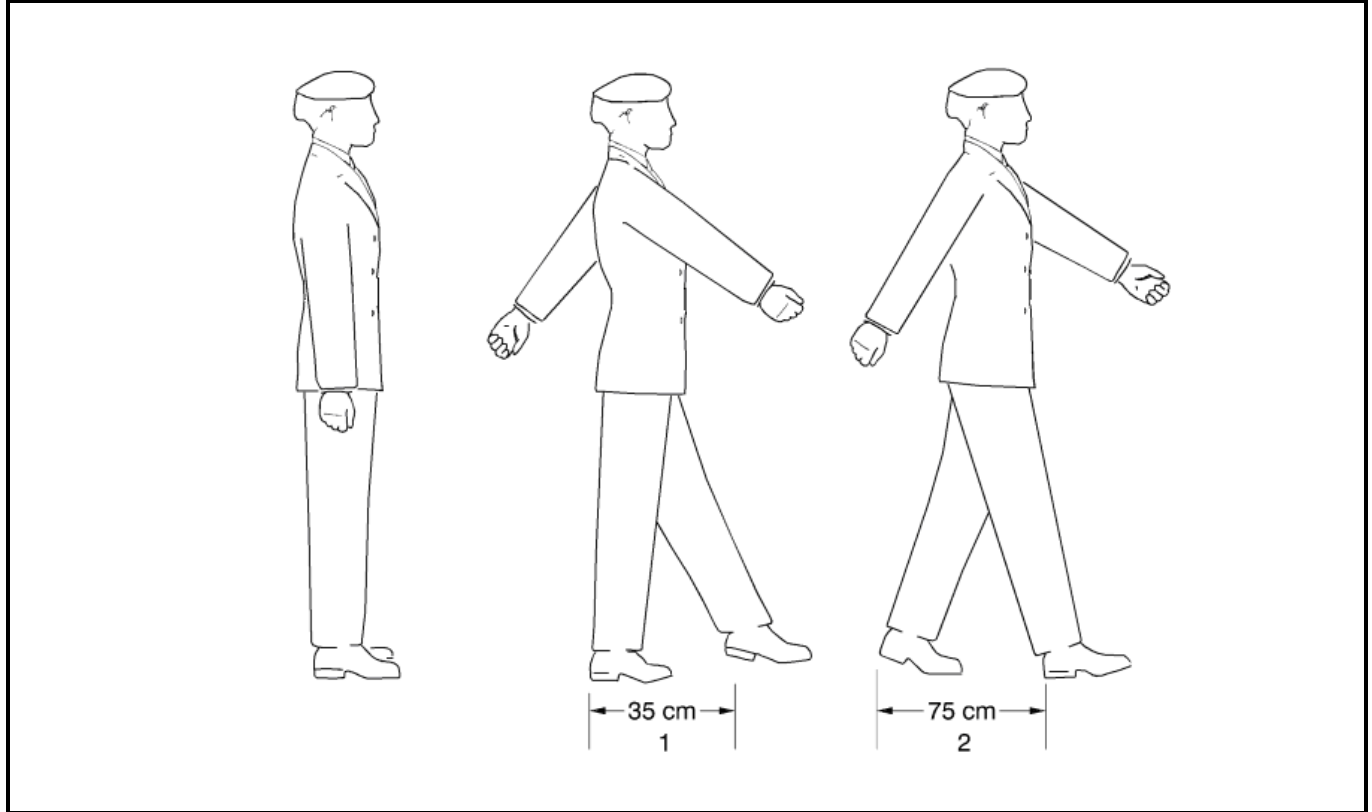

Figure 3-2 Marching in Quick Time

12. As illustrated in Figure 3-2, on the command QUICK MARCH BY NUMBERS, SQUAD – ONE, squad members shall:
 - a. shoot the left foot forward one half pace, toe up;
 - b. strike the heel on the ground first and keep the toe pointed directly forward; and
 - c. simultaneously, swing the right arm straight forward and the left arm straight to the rear, waist high.
13. On the command SQUAD – TWO, squad members shall:
 - a. continue marching with subsequent paces of standard length;
 - b. bring the legs forward successively in a straight line;
 - c. swing the arms forward successively in a straight line from the shoulder, front to rear, with hands closed as in the position of attention; and
 - d. maintain dressing by the directing flank.
14. During basic training, recruits shall be directed to swing arms breast-pocket high in order to build agility. Commanding officers may continue this direction at their discretion.
15. On the command QUICK – MARCH, the two movements are combined.

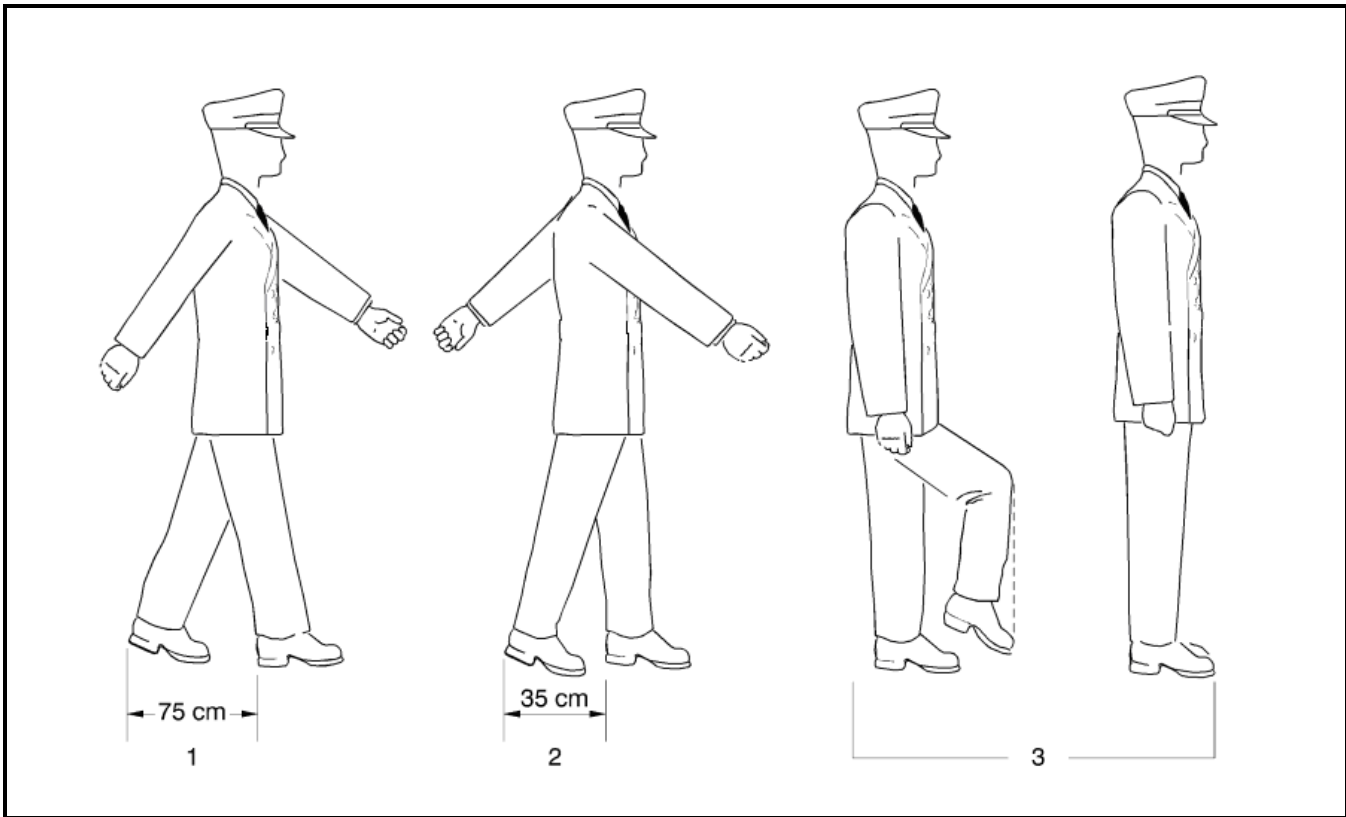

Figure 3-3 Halting in Quick Time

16. As illustrated in Figure 3-3, on the command HALT BY NUMBERS, SQUAD – ONE given as the left foot is forward and on the ground, squad members shall:

- a. check the forward movement by placing the right foot flat on the ground naturally, using the heel as a brake; and
- b. swing the left arm forward and the right arm to the rear.

17. On the command SQUAD – TWO, squad members shall:

- a. take a half pace with the left foot, placing it flat on the ground; and
- b. swing the right arm forward and the left to the rear.

18. On the command SQUAD – THREE, squad members shall:

- a. bend the right knee, straightening it in double time; and
- b. simultaneously, cut the arms to the side as quickly as possible and assume the position of attention.

19. On the command SQUAD – HALT, the three movements are combined in quick time. The timing is called as “one, one-two”.

20. The command QUICK – MARCH shall always be given to ensure that troops step off in time with a band or another body of troops which is already on the march. It is given on successive right feet of the group which is already moving, i.e., QUICK on the right foot of the marching troops and MARCH on the next right foot.

21. The quick march is performed in a brisk and forceful manner. It may be desirable when marching long distances out of the general public eye to permit the troops to relax. If so, the commander may order MARCH AT – EASE. The cadence and pace length remain unchanged, but the troops may otherwise relax. The command to

return to normal marching style is MARCH AT ATTENTION. Commanders shall not permit troops to march at ease in public parades, ceremonies or when entering or leaving barracks.

MARCHING AND HALTING IN DOUBLE TIME

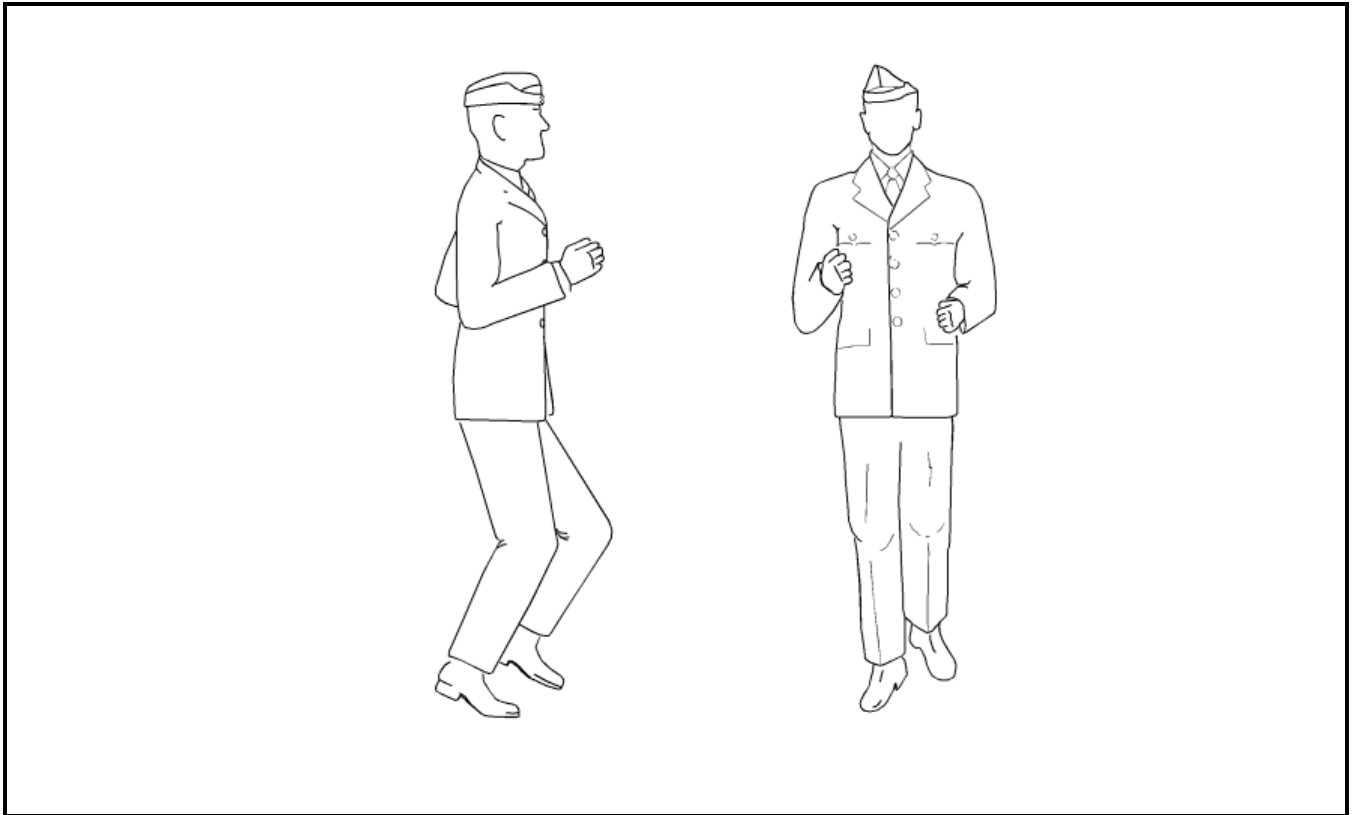

Figure 3-4 Marching in Double Time

22. As illustrated in Figure 3-4, on the command DOUBLE – MARCH, squad members shall:
 - a. step off with the left foot and double on the balls of the feet with easy swinging strides, inclining the body slightly forward;
 - b. raise the feet clear of the ground at each pace;
 - c. bend the arms at the elbow and, with the hands closed, swing the arms naturally from the shoulder; and
 - d. maintain dressing by the directing flank.
23. On the command SQUAD – HALT given as the left foot is forward and on the ground, squad members shall:
 - a. complete two forward paces; and
 - b. bring the right foot to the left after the second pace and simultaneously cut the arms to the sides and assume the position of attention.
24. It is normal to change into quick time before ordering HALT from double time.

MARCHING AND HALTING IN SLOW TIME

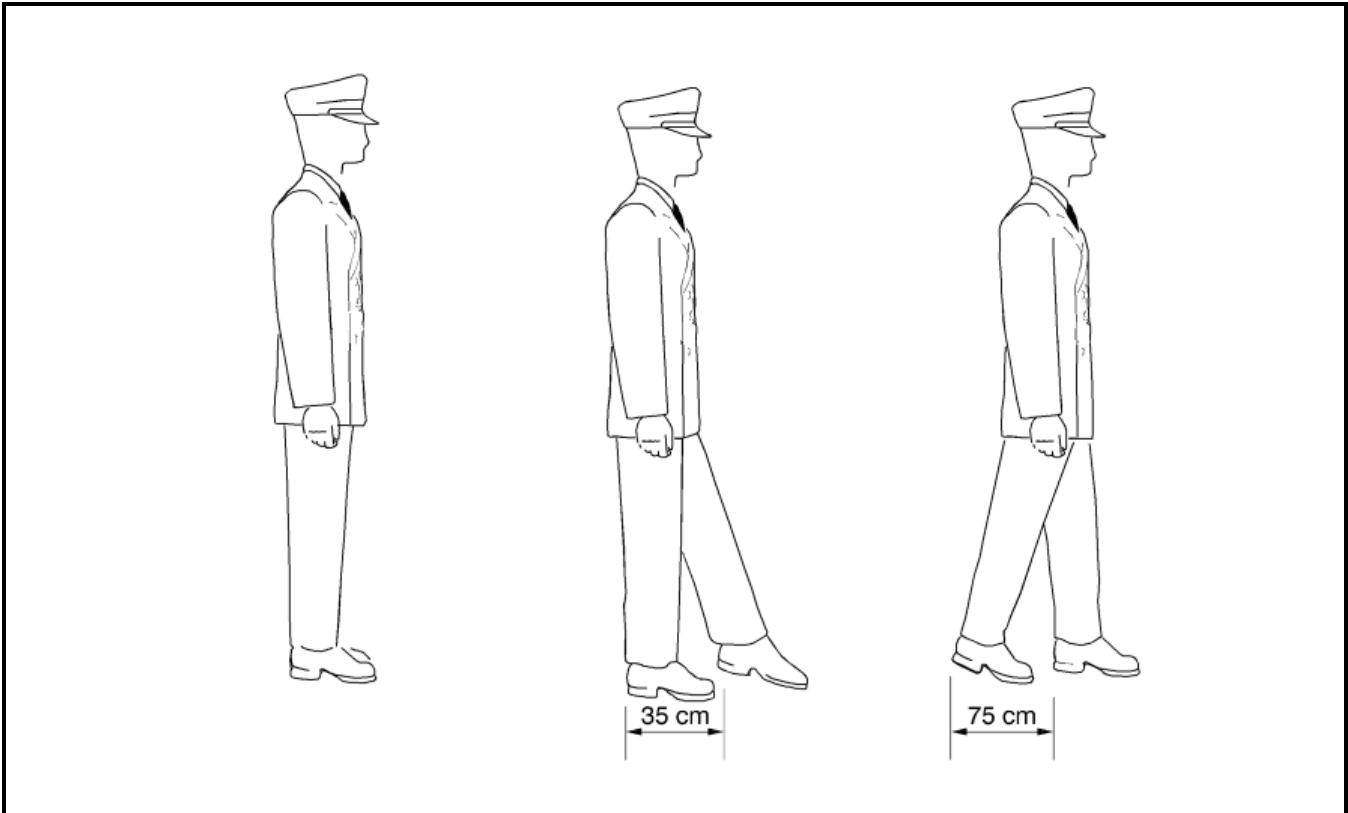

Figure 3-5 Marching in Slow Time

25. The slow march develops balance and good carriage and is traditionally part of CAF ceremonial.
26. As illustrated in Figure 3-5, on the command SLOW – MARCH, squad members shall:
 - a. maintain the head and body erect and square to the front, arms steady at the sides, the neck firmly in the back of the collar;
 - b. shoot the left foot forward smoothly, with the toes just clear of the ground turned out slightly and pointing downwards. Then, without hesitation, complete a gliding half pace, with the ball of the left foot coming to the ground first. All subsequent paces are of standard length and accomplished in the same manner as above. There is no hesitation between the shooting and gliding motions; and
 - c. the leg that is forward is straightened as much as possible.
27. Until balance and coordination are achieved, the slow march may be taught initially by having the squad stroll along at a rate of 60 paces to the minute, arms held behind the back and with the toe pointed down, making sure consecutive movements of the feet are smooth and without hesitation. After further practice, the arms shall be held at the sides until the slow march is perfected.

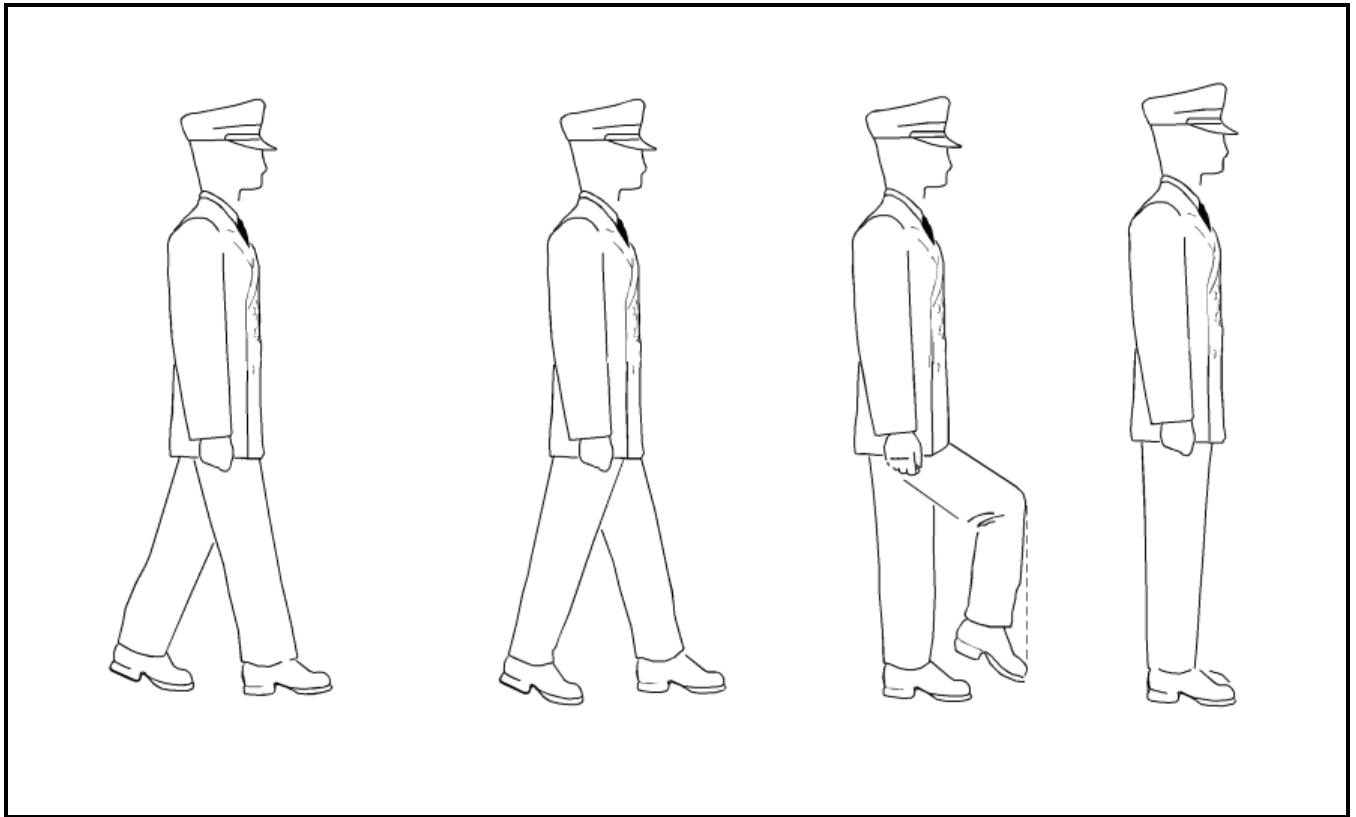

Figure 3-6 Halting in Slow Time

28. As illustrated in Figure 3-6, on the command SQUAD HALT BY NUMBERS, SQUAD – ONE, given as the right foot is forward and on the ground, squad members shall take a further half pace with the left foot in slow time.

29. On the command SQUAD – TWO, squad members shall bend the right knee and bring the right foot forward in quick time and assume the position of attention.

30. On the command SQUAD – HALT, the two movements are combined. The timing is counted as “one-two”.

31. The slow march is tiring over long distances and is therefore only used during the most important parts of ceremonies. During some funerals the circumstances may require marching in slow time for long distances without the normal change to quick time. The commander may then order FUNERAL – PACE. Cadence, pace and body posture remain unchanged, but the troops may change the formal gliding motion of the feet to a more relaxed walking motion. Care must be taken to keep ankles relaxed and avoid pointing toes up. Formal foot motion is resumed on the command ATTEN – TION.

STEPPING OUT AND STEPPING SHORT

32. Stepping out is used to increase the distance to be covered without altering the cadence, and stepping short to decrease the distance to be covered without altering the cadence.

33. On the command STEP – OUT given as the left foot is forward and on the ground:

- a. the pace shall be lengthened by about 10 cm on the next left foot; and
- b. the squad shall continue to step out until the command QUICK – MARCH is ordered.

34. On the command QUICK – MARCH given as the left foot is forward and on the ground, the pace will be shortened to the normal length on the next left foot.
35. On the command STEP – SHORT given as the left foot is forward and on the ground:
 - a. the pace shall be shortened by about 20 cm on the next left foot; and
 - b. the squad shall continue to step short until the command QUICK – MARCH is ordered.
36. On the command QUICK – MARCH given as the left foot is forward and on the ground, the pace will be lengthened to the normal length on the next left foot.

MARK TIME, FORWARD AND HALT IN SLOW TIME

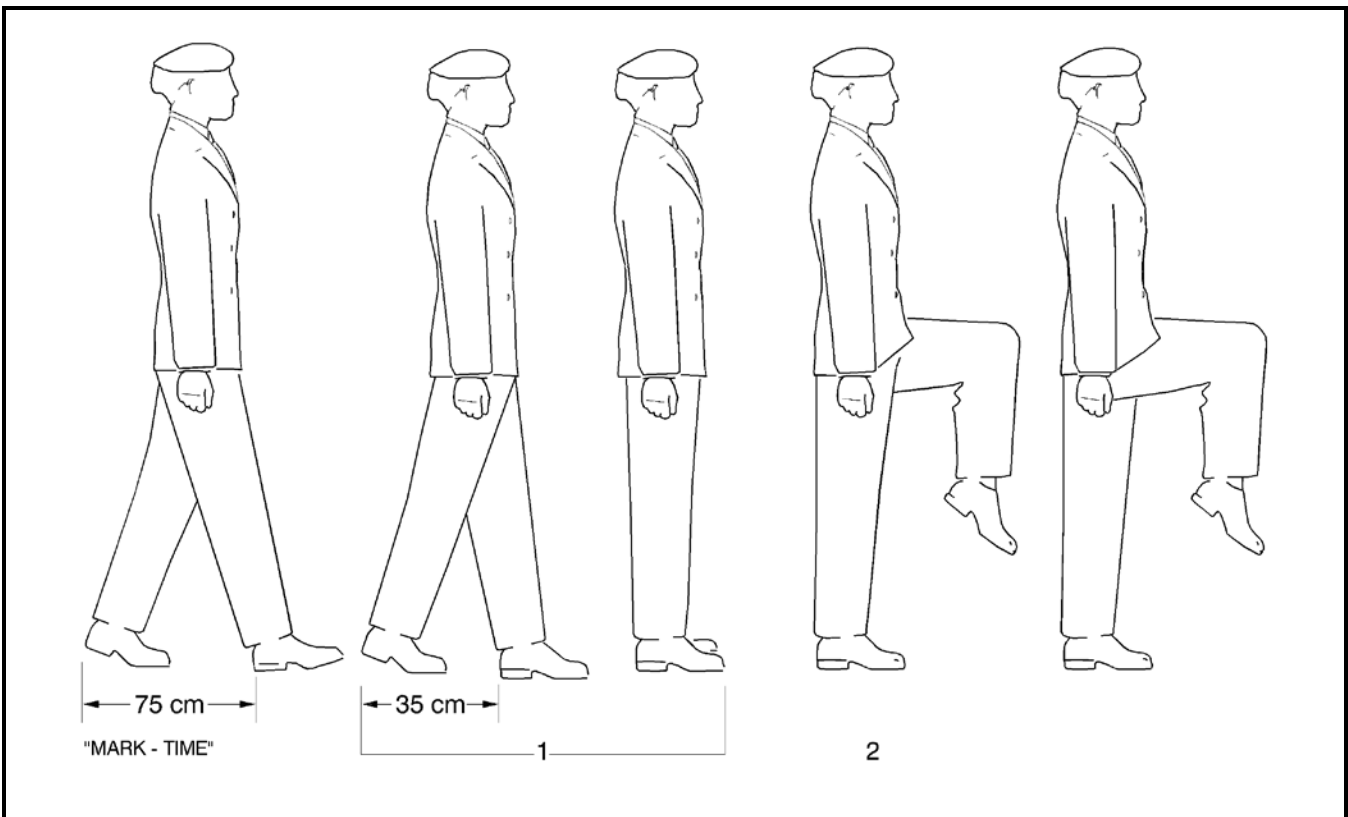

Figure 3-7 Marking Time in Slow Time

37. As illustrated in Figure 3-7, marking time is carried out at the same cadence as for marching. Only the legs are moved and the upper portion of the body remains in the position of attention with arms at the side.
38. On the command MARK TIME BY NUMBERS, SQUAD – ONE given as the right foot is forward on the ground, squad members shall:
 - a. take a half pace with the left foot, placing the foot flat on the ground naturally; and
 - b. maintaining the same cadence, bring the right foot into the left in a straight leg manner, not scraping the ground, and assume the position of attention.
39. On the command SQUAD – TWO, squad members shall:
 - a. bend the left knee so that the thigh is parallel to the ground and the foot at a natural angle;
 - b. place the toe on the ground before the heel as the leg is lowered;

- c. continue to mark time until the command FOR – WARD or HALT is given; and
 - d. avoid stamping feet.
40. On the command MARK – TIME, the two movements are combined.
41. The timing is:
- Count: LEFT – IN – LEFT – RIGHT – LEFT
- Foot: LEFT – RIGHT – LEFT – RIGHT – LEFT
42. On the command FOR – WARD given as the left foot is on the ground, squad members shall:
- a. maintaining the same cadence, straighten the right leg and assume the position of attention; and
 - b. shoot the left foot forward in a half pace, with the toe just clear of the ground, and continue marching in slow time.
43. On the command SQUAD – HALT given as the left foot is on the ground, squad members shall straighten the right leg in quick time and assume the position of attention.
44. The timing for the halt is counted as one in quick time.
45. To mark time from the halt the command shall be, SLOW MARK – TIME.

MARK TIME, FORWARD AND HALT IN QUICK TIME

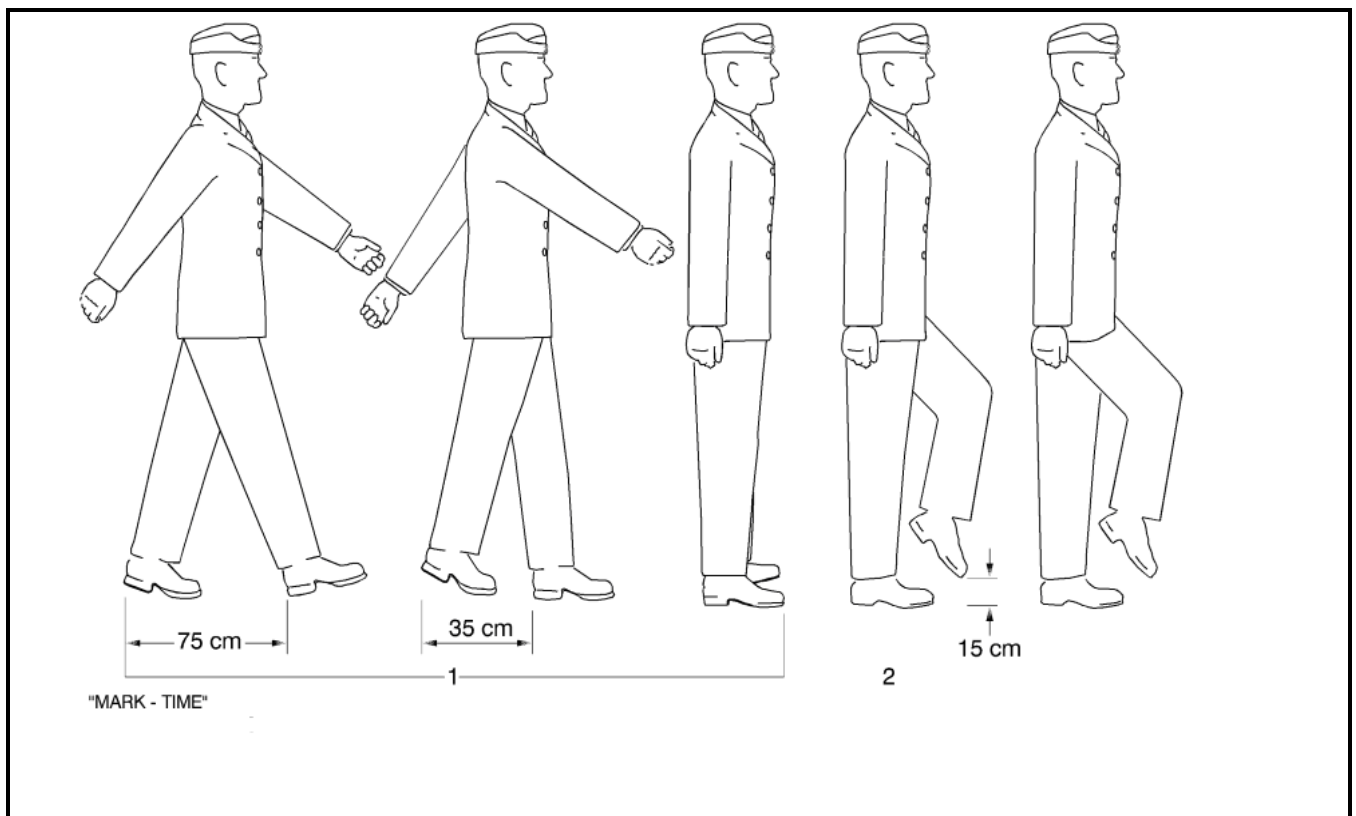

Figure 3- 8 Marking Time in Quick Time

46. Marking time in quick time is carried out at the same cadence as for marching (Figure 3-8).

47. On the command MARK TIME BY NUMBERS, SQUAD – ONE given as the right foot is on the ground, squad members shall:

- a. take a half pace with the left foot, placing the foot flat on the ground naturally;
- b. bring the right foot into the left in a straight leg manner, not scraping the ground;
- c. simultaneously, cut the arms to the sides and assume the position of attention; and
- d. maintain the same cadence.

48. On the command SQUAD – TWO, squad members shall:

- a. bend the left knee;
- b. place the toe on the ground before the heel as the leg is lowered; and
- c. continue to mark time until the command FOR – WARD or HALT is given.

49. On the command MARK – TIME, the two movements are combined.

50. The timing is:

Count: LEFT – IN – LEFT – RIGHT – LEFT

Foot: LEFT – RIGHT – LEFT – RIGHT – LEFT

51. On the command FOR – WARD given as the left foot is on the ground, squad members shall:

- a. straighten the right leg and assume the position of attention;
- b. shoot the left foot forward in a half pace; and
- c. continue marching in quick time, swinging the right arm forward and the left to the rear.

52. On the command SQUAD – HALT given as the left foot is on the ground, squad members shall:

- a. take a further mark time pace with the right foot;
- b. take a further mark time pace with the left foot; and
- c. straighten the right leg in double time and assume the position of attention.

53. The timing for the halt is counted “one, one-two”.

54. To mark time from the halt the command shall be, QUICK MARK – TIME.

WHEELS

55. As illustrated in Figure 3-9, on the command RIGHT (LEFT) – WHEEL, the leading file of threes wheels around one quarter of the circumference of a circle having a radius of 1.25 m, changing direction by 90 degrees.

56. The inner rank shall step short, the center rank shall maintain the length of pace and the outside rank shall step out, without altering the cadence, to enable the file to wheel in line.

57. Dressing is maintained by the inner flank while wheeling. The head will be kept to the front.

58. When the leading file has wheeled 90 degrees, it shall march in the new direction, resuming the normal pace. On completion of the wheel, the directing flank shall be confirmed or indicated by order, BY THE RIGHT (LEFT), normally maintaining the directing flank noted in paragraph 11.

59. The remaining files shall follow the lead file, wheeling at exactly the same point.

60. If the squad is ordered to halt or mark time, and only part of the squad has completed the wheel, the squad shall remain in this position unless the command REAR FILES – COVER is ordered. On the command REAR FILES – COVER, by taking short quick paces with the left foot first, the files at the rear cover off the files that are facing the new direction.

61. When it is desired to wheel less than an angle of 90 degrees, the command FOR – WARD is ordered when the leading file is facing the required direction.

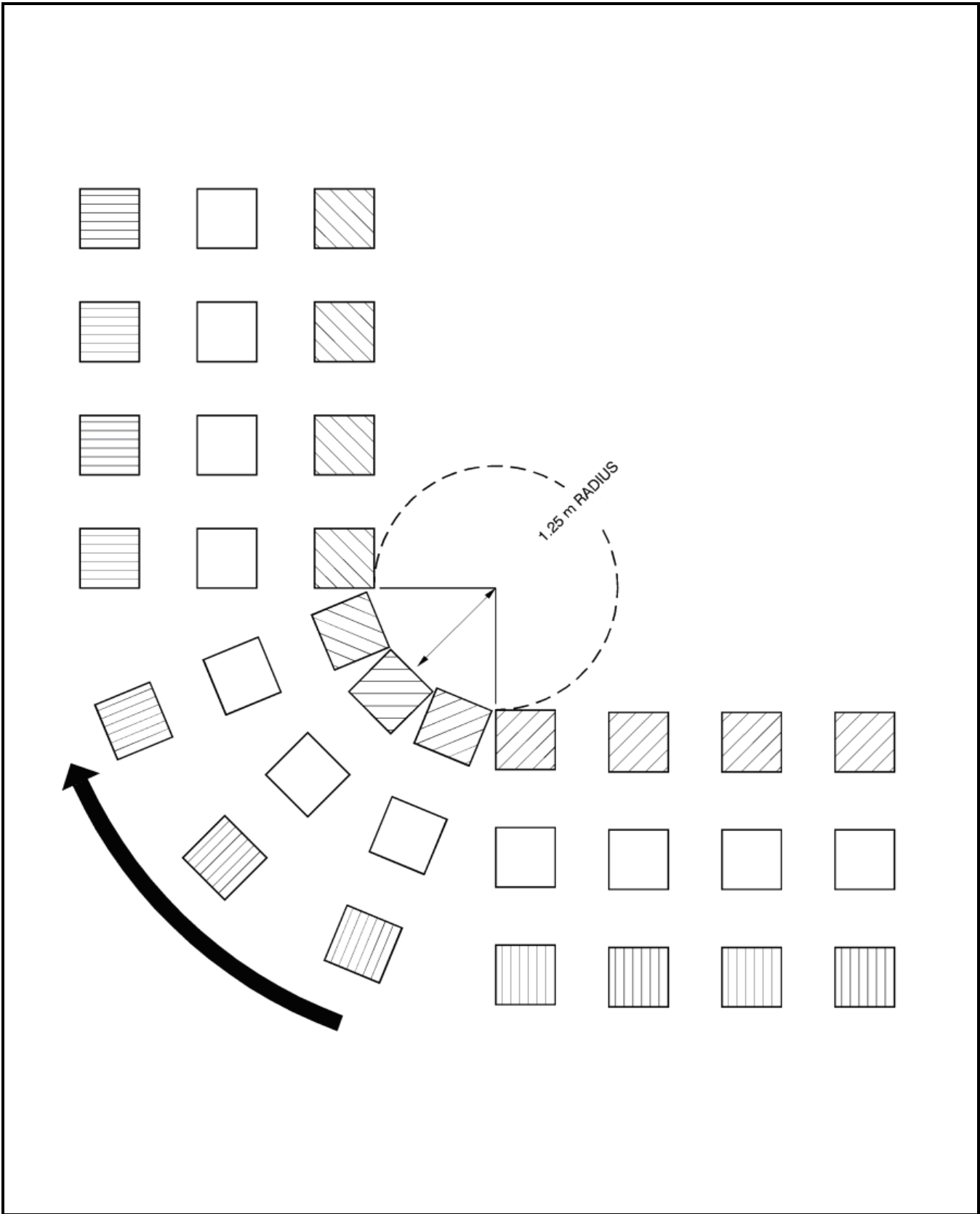

Figure 3-9 Wheeling

CHANGE STEP ON THE MARCH

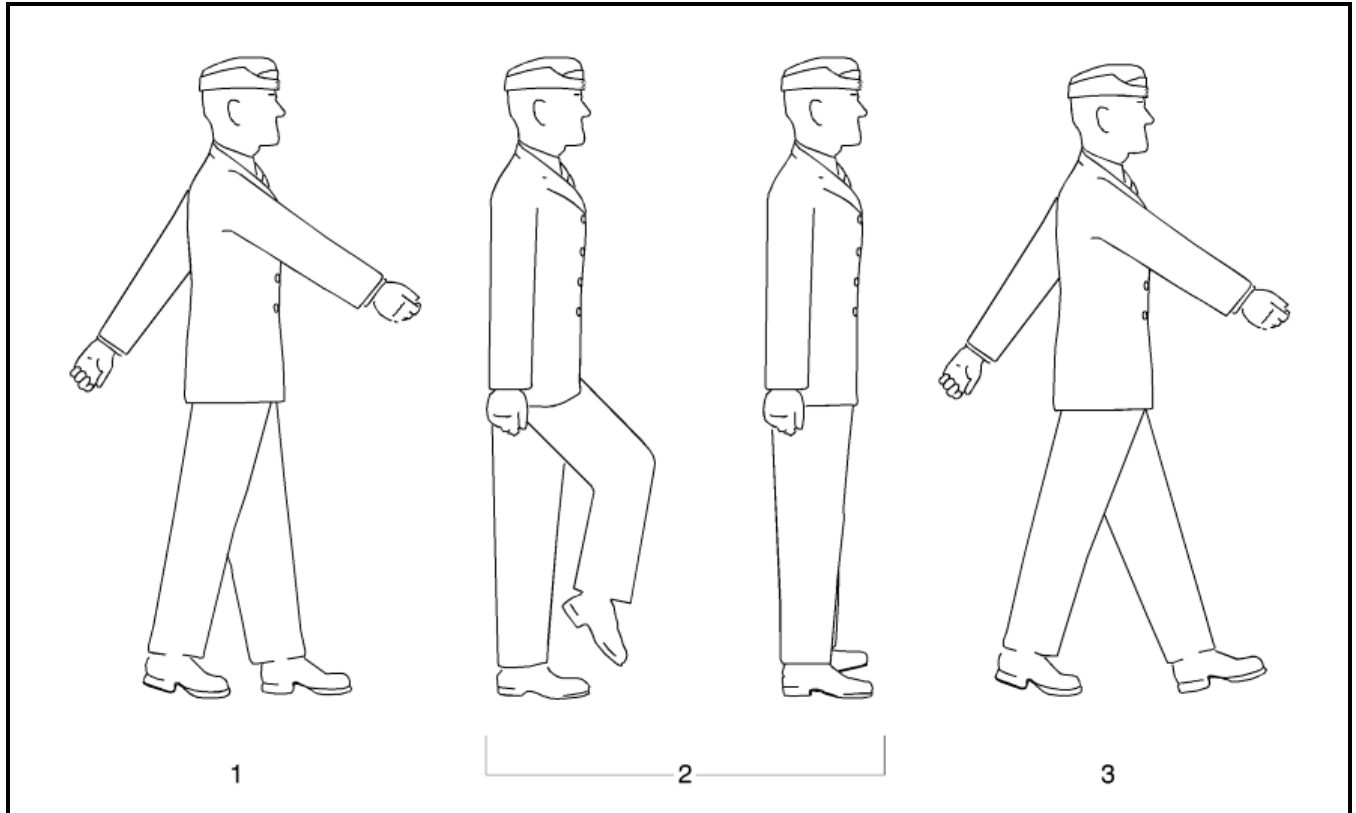

Figure 3-10 Change Step on the March in Quick Time

62. In slow time, on the command CHANGE STEP BY NUMBERS, SQUAD – ONE given as the right foot is forward and on the ground, squad members shall:

- a. complete a half pace with the left foot;
- b. force the weight forward on the left foot; and
- c. raise the right heel off the ground.

63. On the command SQUAD – TWO, squad members shall:

- a. bring the right foot forward in quick time by bending the right knee;
- b. straighten the right leg in quick time and place the right foot smartly beside the left; and
- c. as the right foot strikes the ground, shoot the left foot forward in a half pace just above the ground with the toe pointed down as in slow time.

64. On the command SQUAD – THREE, squad members shall complete the glide pace with the left foot and carry on slow marching.

65. On the command CHANGE – STEP, the three movements are combined. The timing is counted as “left, right, left” in quick time, thus maintaining slow march cadence while changing the step.

66. In quick time (Figure 3-10), on the command CHANGE STEP BY NUMBERS SQUAD – ONE given as the right foot is forward and on the ground, squad members shall:

- a. complete a half pace with the left foot;

- b. swing the right arm forward;
 - c. swing the left arm to the rear;
 - d. force the weight forward on the left foot; and
 - e. raise the right heel off the ground.
67. On the command SQUAD – TWO, squad members shall:
- a. cut the arms to the side as in the position of attention;
 - b. bring the right foot forward in double time by bending the right knee;
 - c. straighten the right leg in double time and place the right foot smartly beside the left; and
 - d. as the right foot strikes the ground, shoot the left foot forward in a half pace, landing on the heel with the toe up.
68. On the command SQUAD – THREE, squad members shall:
- a. swing the right arm forward;
 - b. swing the left arm to the rear; and
 - c. continue marching in quick time.
69. On the command CHANGE – STEP, the three movements are combined. The timing is counted, as “left, right, left” in double time, thus maintaining quick mark cadence.

CHANGE STEP WHEN MARKING TIME

70. In slow time or quick time, on the command CHANGE – STEP given as the right foot is on the ground, squad members shall:
- a. take two successive mark time paces with the left foot; and
 - b. continue marking time.
71. The timing is counted as “left, left-right” in the same cadence as marking time.

FORM HOLLOW SQUARE

72. The squad shall be in line in three ranks prior to forming hollow square (Figure 3-11).
73. On the command FORM HOLLOW SQUARE, CENTRE RANK RIGHT, REAR RANK LEFT – TURN, the squad acts as ordered.
74. On the command CENTRE RANK LEFT WHEEL, REAR RANK RIGHT WHEEL, QUICK – MARCH, the squad acts as ordered.
75. The command MARK – TIME shall be given when the rear individuals of the centre and rear ranks are one pace in front of the front rank.
76. On the command SQUAD – HALT, the squad acts as ordered.
77. On the command CENTRE RANK LEFT, REAR RANK RIGHT – TURN, the squad acts as ordered.
78. The reverse procedure is used to reform the squad into three ranks.

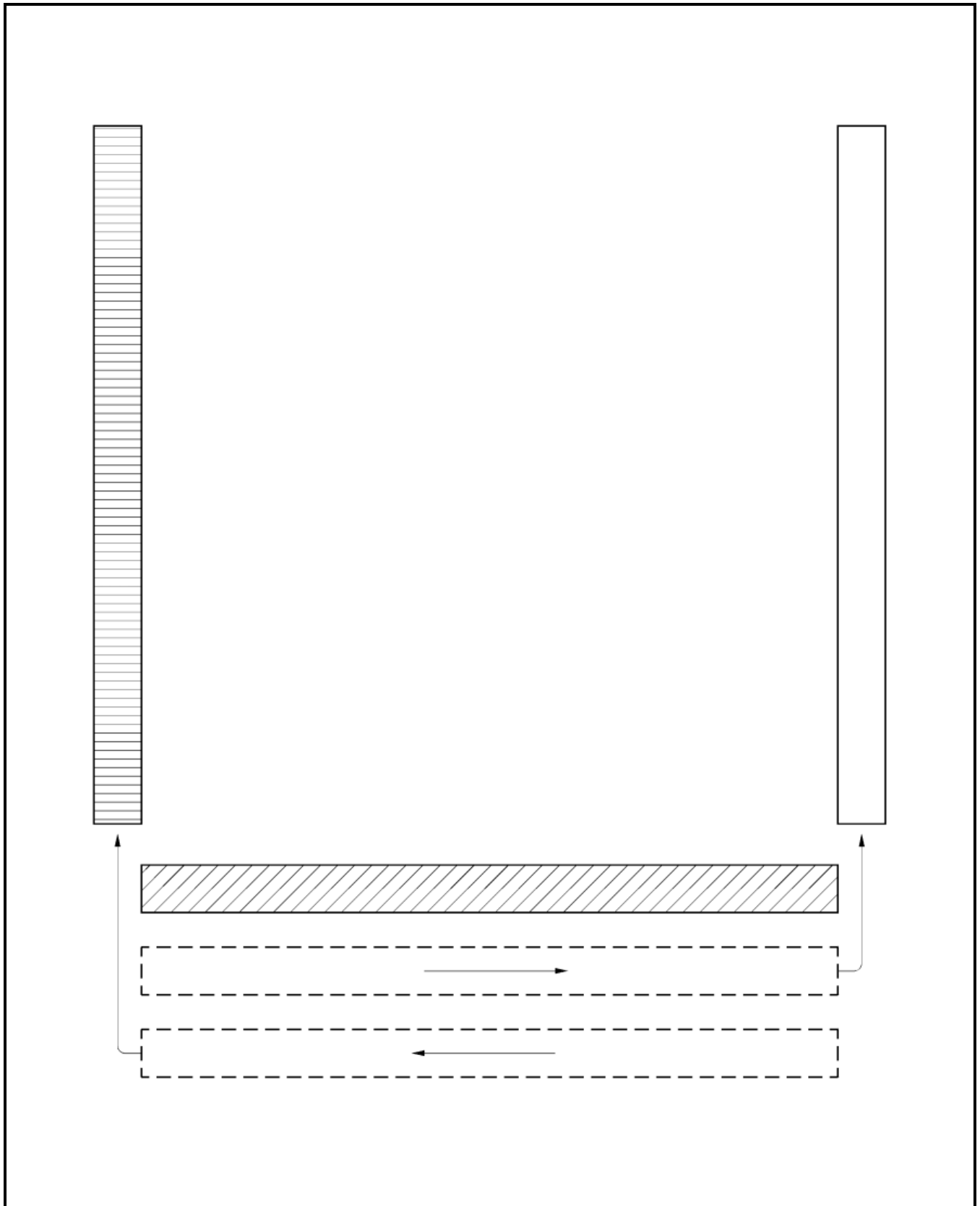

Figure 3- 11 Forming Hollow Square

SALUTE ON THE MARCH WITHOUT ARMS

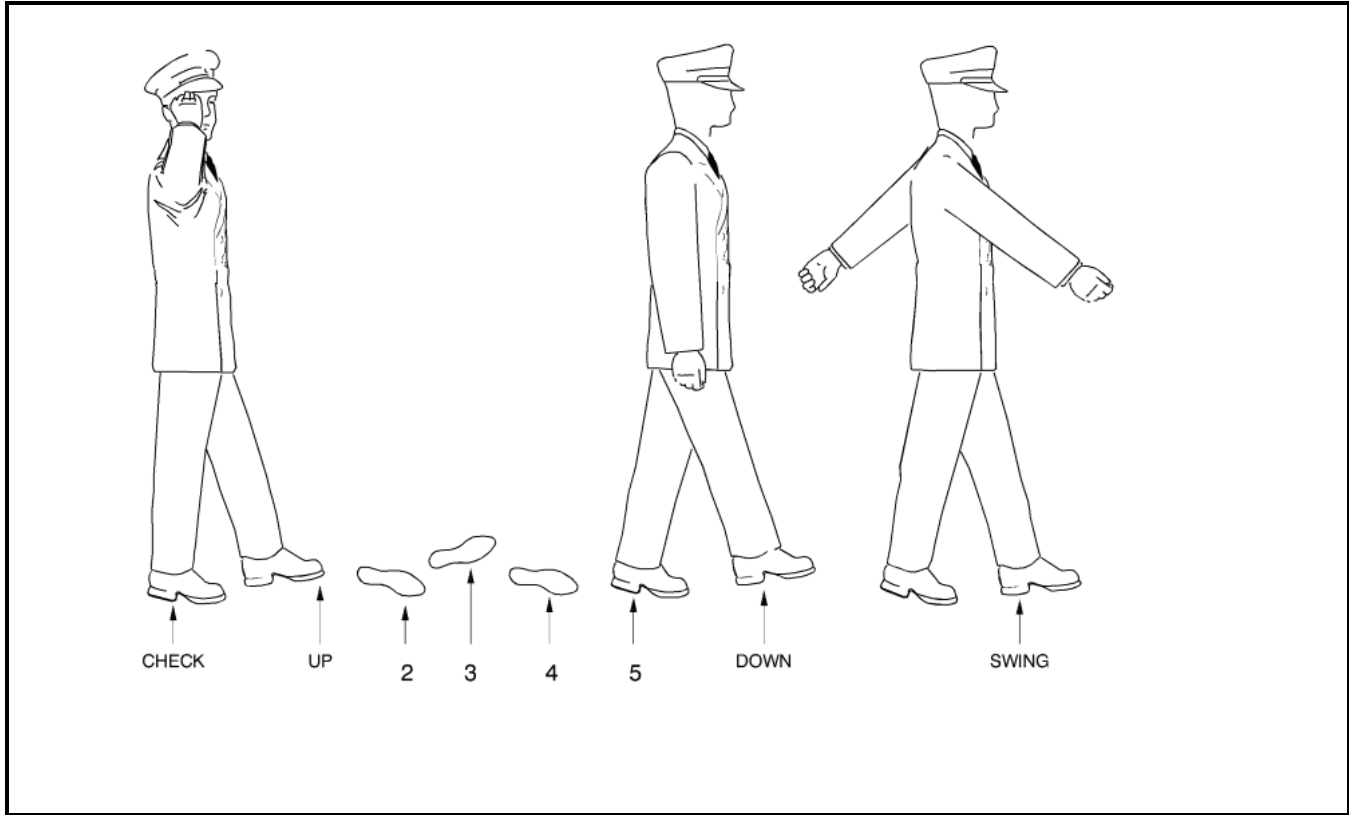

Figure 3-12 Saluting on the March without Arms

79. The movements of the salute to the front and to a flank shall be executed as described in Chapter 2, paragraphs 36 to 43.

80. When a service member salutes on the march, he shall commence the drill movement five paces before reaching an officer, look directly into the officer's eyes by turning his head in the required direction on the commencement of the salute, and complete the salute one pace beyond him. This permits the officer to return the salute before the member has passed (Figure 3-12).

81. On the command TO THE RIGHT (LEFT) SALUTE BY NUMBERS, SQUAD – ONE given as the left foot is forward and on the ground, squad members shall:

- a. complete the next pace with the right foot; and
- b. swing the left arm forward and the right arm to the rear normally.

82. On the command SQUAD – TWO, squad members shall:

- a. complete the next pace with the left foot;
- b. cut the left arm to the side; and
- c. cut the right arm forward to the side and then up into the salute in one continuous movement. While saluting, the head is turned right (left) as far as possible without straining as appropriate.

83. On the command SQUAD – THREE, squad members shall complete four paces in quick time, ending with the left foot forward.

84. On the command SQUAD – FOUR, squad members shall:
- complete a pace with the right foot; and
 - cut the right arm to the side.
85. On the command SQUAD – FIVE, squad members shall continue marching.
86. On the command TO THE RIGHT (LEFT) –SALUTE, the movements are combined.
87. The timing for the salute is counted as follows:
- Count: CHECK – UP – TWO – THREE – FOUR – FIVE – DOWN – SWING
- Foot: RIGHT – LEFT – RIGHT – LEFT – RIGHT – LEFT – RIGHT – LEFT
88. When teaching by numbers, on all commands the weight of the body is on the forward foot with the rear heel off the ground; however on the command SQUAD – TWO, the weight is on the rear foot with the toe up. The squad shall call the time in accordance with paragraph 87.

PAYING UNIT COMPLIMENTS WITH A SQUAD ON THE MARCH

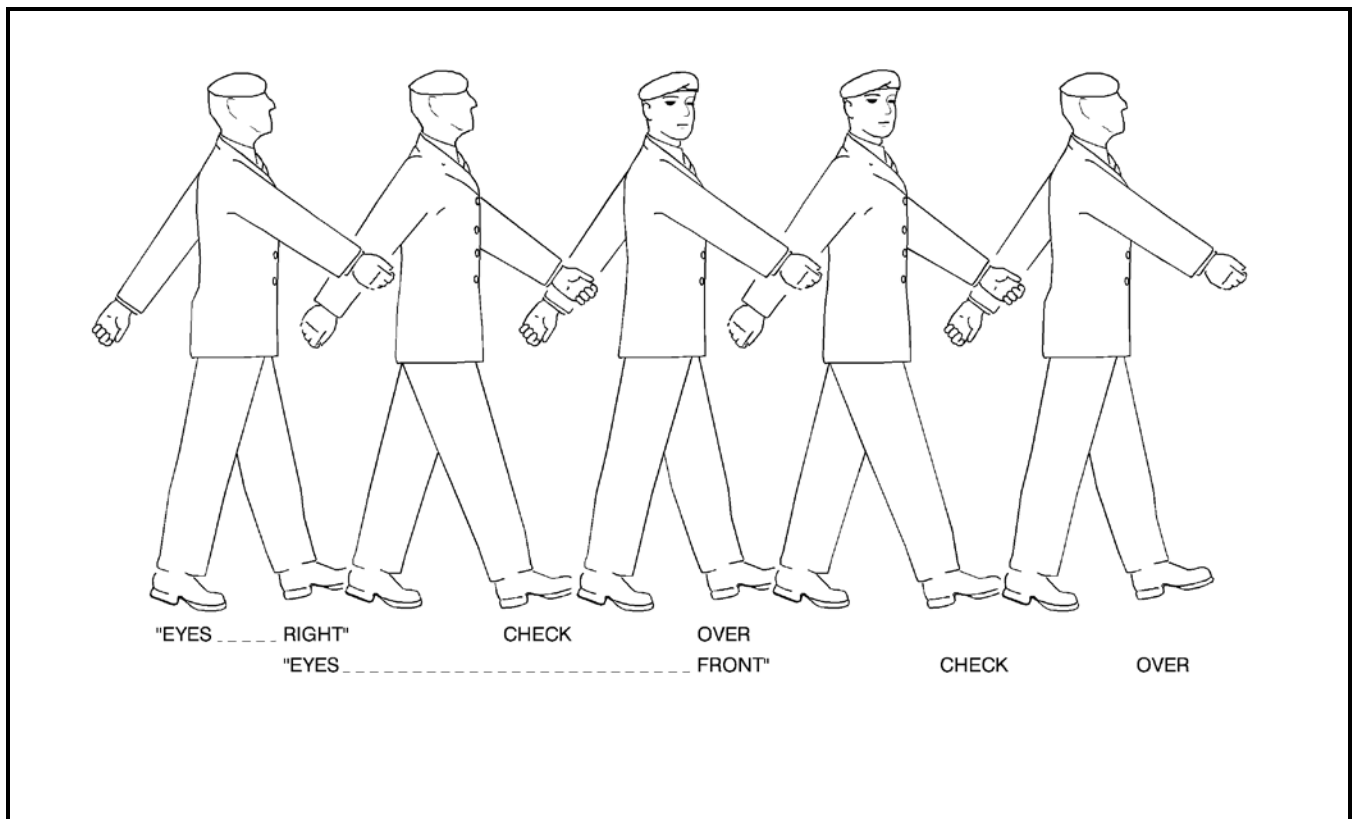

Figure 3-13 Eyes Right on the March without Arms

89. As illustrated in Figure 3-13, on the command EYES – RIGHT (LEFT), given as the left foot is forward and on the ground:
- squad members shall complete the next pace forward with the right foot and, as the left foot comes forward again and strikes the ground, turn the head and eyes to the right (left) as far as possible without straining and look directly into the eyes of the personage being saluted;

- b. squad members shall continue swinging arms;
 - c. the leading person on the directing flank shall maintain head and eyes to the front to keep direction; and
 - d. the person in command of the squad salutes.
90. On the command EYES – FRONT given as the left foot is forward and on the ground:
- a. squad members shall complete the next pace forward with the right foot and, as the left foot comes forward again and strikes the ground, cut the head and eyes smartly to the front; and
 - b. the person in command of the squad completes the salute on the right foot by checking his arms to his sides and commences to swing his arms on the following pace with the left foot.

URNS AND INCLINES ON THE MARCH IN SLOW TIME

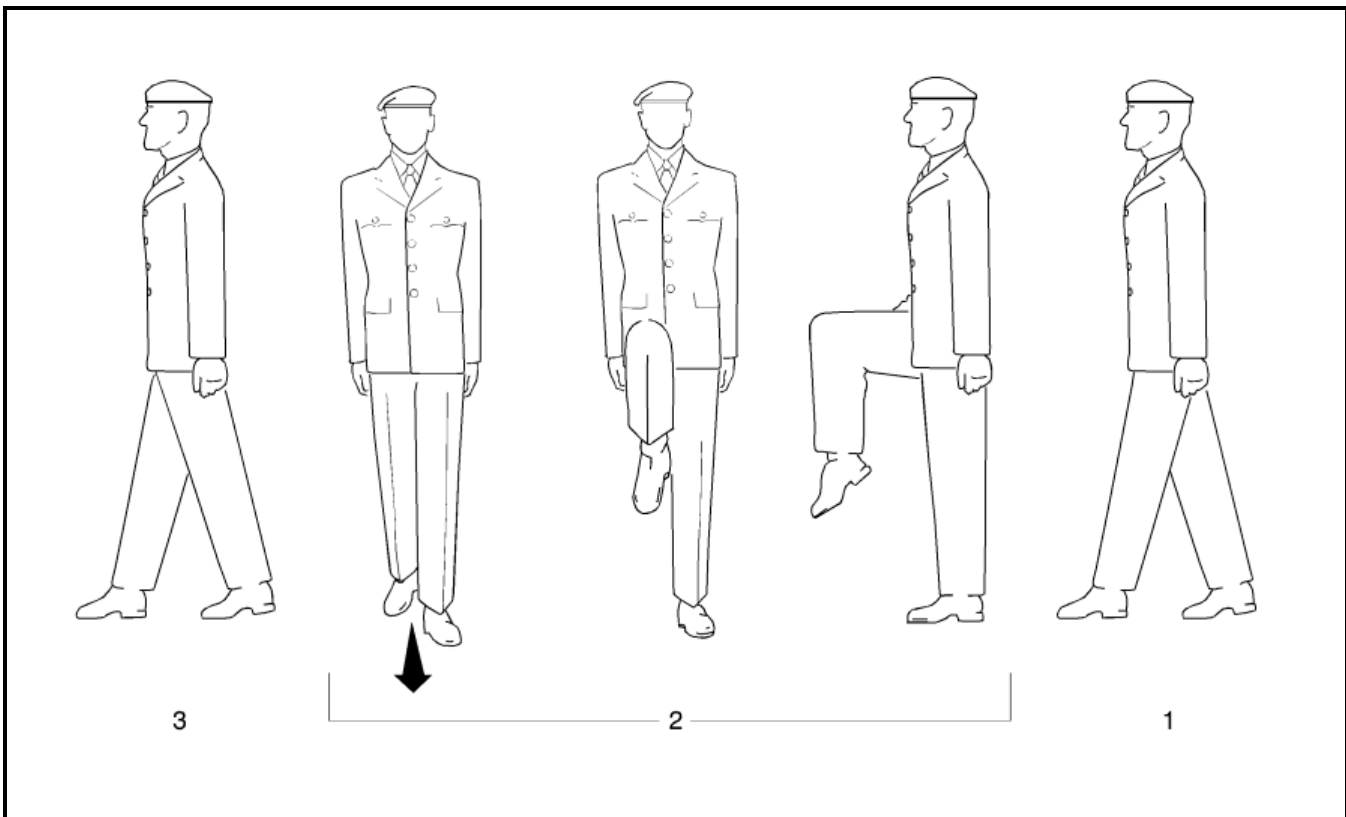

Figure 3-14 Turns in Slow Time

91. Turns and inclines on the march are executed to change direction (see Figure 3-14).
92. On the command LEFT TURN BY NUMBERS, SQUAD – ONE given as the right foot is forward and on the ground, squad members shall complete a half pace with the left foot and freeze.
93. On the command SQUAD – TWO, squad members shall:
- a. bend the right knee so the upper leg is parallel to the ground;
 - b. using the momentum of the knee, force the shoulders 90 degrees to the left to face the new direction, while simultaneously pivoting on the ball of the left foot 90 degrees to the left;
 - c. straighten the right leg as in the position of attention;

- d. immediately shoot the left foot forward in a half pace with the toe just clear of the ground;
- e. keep the body and head held up; and
- f. keep the arms, body and head steady.

94. On the command SQUAD – THREE, squad members shall complete the half pace with the left foot and continue marching.

95. On the command LEFT – TURN, the three movements are combined into one continuous movement and the cadence is maintained.

96. The timing is:

Count: CHECK – PIVOT – LEFT – RIGHT – LEFT

Foot: LEFT – RIGHT – LEFT – RIGHT – LEFT

97. On the command LEFT IN – CLINE, the drill described for turning to the left is followed except that the turn is made through 45 degrees.

98. On the command RIGHT TURN BY NUMBERS, SQUAD – ONE given as the left foot is forward and on the ground, squad members shall complete a half pace with the right foot.

99. On the command SQUAD – TWO, squad members shall:

- a. bend the left knee so the upper leg is parallel to the ground;
- b. using the momentum of the knee, force the shoulders 90 degrees to the right to face the new direction, while simultaneously pivoting on the ball of the right foot 90 degrees to the right;
- c. straighten the left leg as in the position of attention;
- d. immediately shoot the right foot forward in a half pace with the toe just clear of the ground;
- e. keep the body and head held up; and
- f. keep the arms, body, and head steady.

100. On the command SQUAD – THREE, squad members shall complete the half pace with the right foot and continue marching.

101. On the command RIGHT – TURN, the three movements are combined into one continuous movement and the cadence is maintained.

102. The timing is:

Count: CHECK – PIVOT – RIGHT – LEFT – RIGHT

Feet: RIGHT – LEFT – RIGHT – LEFT – RIGHT

103. On the command RIGHT IN – CLINE, the drill described for turning to the right is followed except that the turn is made through 45 degrees.

URNS AND INCLINES ON THE MARCH IN QUICK TIME

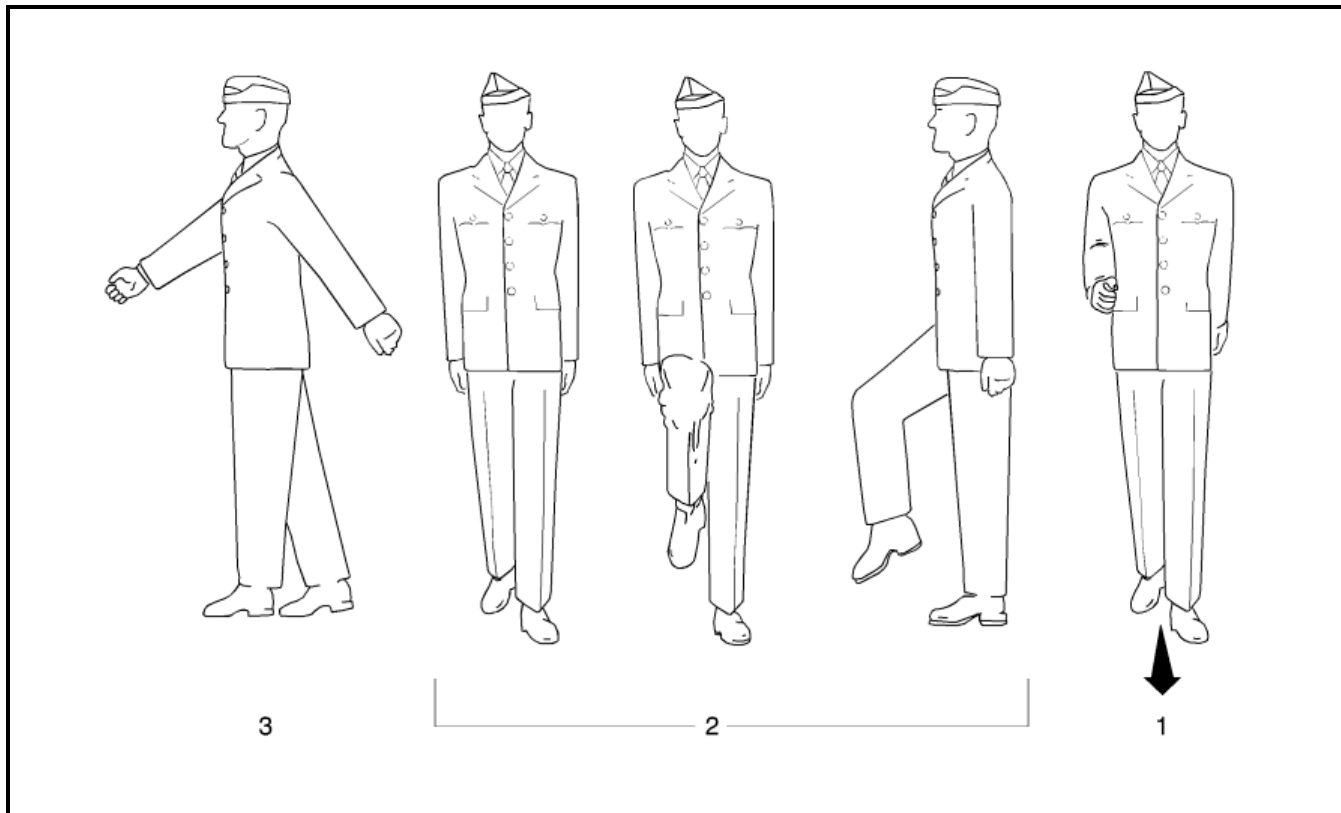

Figure 3-15 Turns in Quick Time

104. Turns and inclines on the march are executed to change direction (see Figure 3-15).

105. On the command LEFT TURN BY NUMBERS, SQUAD – ONE, given as the right foot is forward and on the ground, squad members shall complete a half pace with the left foot with the right arm swung forward and the left to the rear.

106. On the command SQUAD – TWO, squad members shall:

- a. cut the arms to the side as in the position of attention;
- b. bend the right knee;
- c. using the momentum of the knee, force the shoulders 90 degrees to the left to face the new direction, while simultaneously pivoting on the ball of the left foot 90 degrees to the left;
- d. straighten the right leg as in the position of attention;
- e. immediately shoot the left foot forward in a half pace with the toe just clear of the ground;
- f. keep the body and head held up; and
- g. keep the arms, body and head steady.

107. On the command SQUAD – THREE, squad members shall complete the half pace with the left foot and continue marching (swinging the arms).

108. On the command LEFT – TURN, the three movements are combined into one continuous movement and the cadence is maintained.

109. The timing is:

Count: CHECK – PIVOT – LEFT – RIGHT – LEFT

Feet: LEFT – RIGHT – LEFT – RIGHT – LEFT

110. On the command LEFT IN – CLINE, the drill described for turning to the left is followed except that the turn is made to 45 degrees.

111. On the command RIGHT TURN BY NUMBERS, SQUAD – ONE given as the left foot is forward and on the ground, squad members shall complete a half pace with the right foot, swing the left arm forward and the right to the rear.

112. On the command SQUAD – TWO, squad members shall:

- a. cut the arms to the side as in the position of attention;
- b. bend the left knee;
- c. using the momentum of the knee, force the shoulders 90 degrees to the right to face the new direction, while simultaneously pivoting on the ball of the right foot 90 degrees to the right;
- d. straighten the left leg as in the position of attention;
- e. immediately shoot the right foot forward in a half pace with the toe just clear of the ground;
- f. keep the body and head held up; and
- g. keep the arms, body and head steady.

113. On the command SQUAD – THREE, squad members shall complete the half pace with the right foot and continue marching.

114. On the command RIGHT – TURN, the three movements are combined into one continuous movement and the cadence is maintained.

115. The timing is counted as:

Count: CHECK – PIVOT – RIGHT – LEFT – RIGHT

Feet: RIGHT – LEFT – RIGHT – LEFT – RIGHT

116. On the command RIGHT IN – CLINE, the drill described for turning to the right is followed, except that the turn is made to 45 degrees.

ABOUT TURN ON THE MARCH IN SLOW TIME

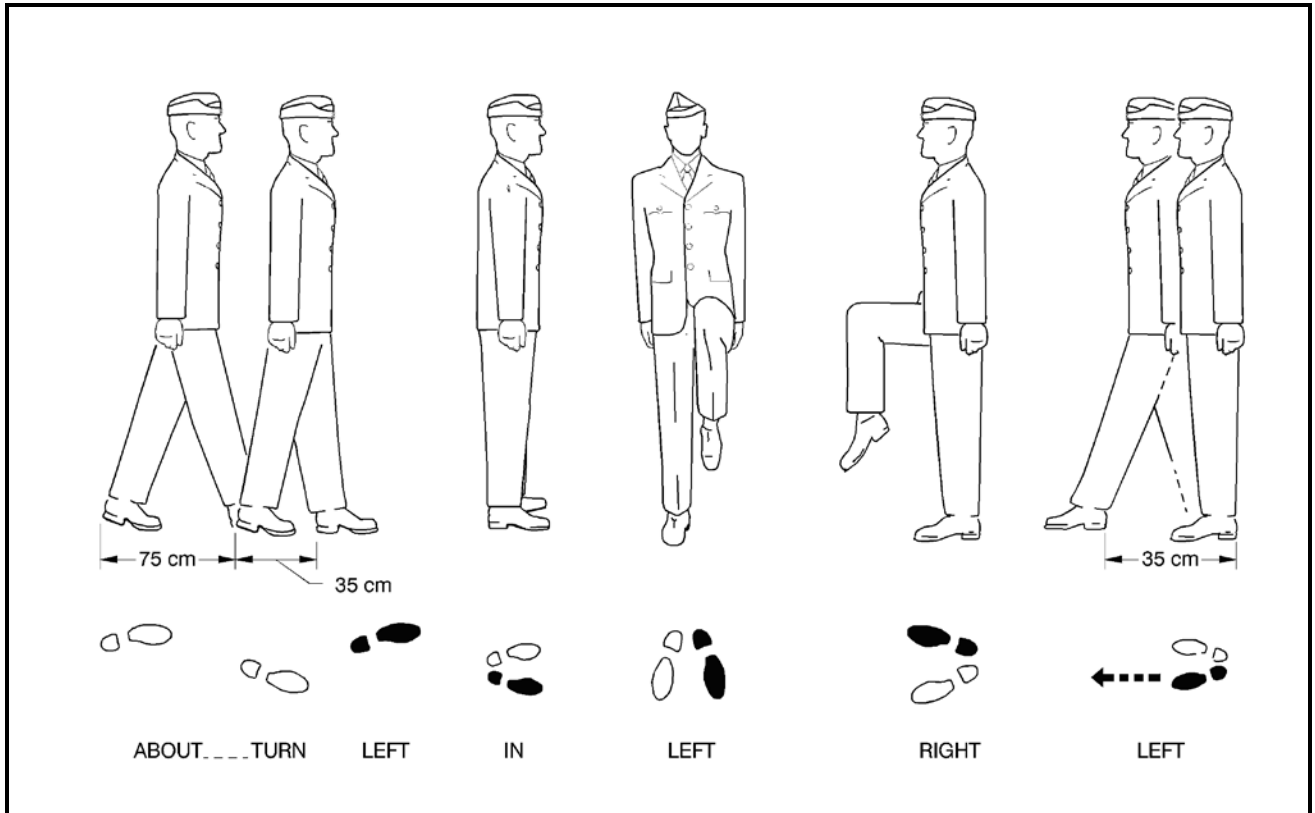

Figure 3-16 About Turn in Slow Time

117. On the command ABOUT TURN BY NUMBERS, SQUAD – ONE given as the right foot is forward and on the ground (Figure 3-16), squad members shall:

- a. take a half pace with the left foot placing the foot flat on the ground naturally;
- b. bring the right foot in to the left, in a straight-leg manner without scraping the ground, to the position of attention;
- c. maintain the same cadence; and
- d. keep the arms to the side.

118. On the command SQUAD – TWO, squad members shall:

- a. maintain the arms at the sides;
- b. pivot on the ball of the right foot to force the body through a turn of 90 degrees to the right;
- c. simultaneously, bend the left knee so that the thigh is parallel to the ground; and
- d. lower the leg smartly to the ground to assume the position of attention.

119. On the command SQUAD – THREE, squad members shall:

- a. maintain the arms at the sides;
- b. pivot on the ball of the left foot to force the body through a turn of 90 degrees to the right;
- c. simultaneously, bend the right knee so that the thigh is parallel to the ground; and

d. lower the leg smartly to the ground to assume the position of attention.

120. On the command SQUAD – FOUR, squad members shall step off in slow time with a half pace with the left foot in the new direction.

121. On the command ABOUT – TURN, the four movements are combined and the cadence is maintained.

122. The timing is:

Count: LEFT – IN – LEFT – RIGHT – LEFT

Feet: LEFT – RIGHT – LEFT – RIGHT – LEFT

ABOUT TURN ON THE MARCH IN QUICK TIME

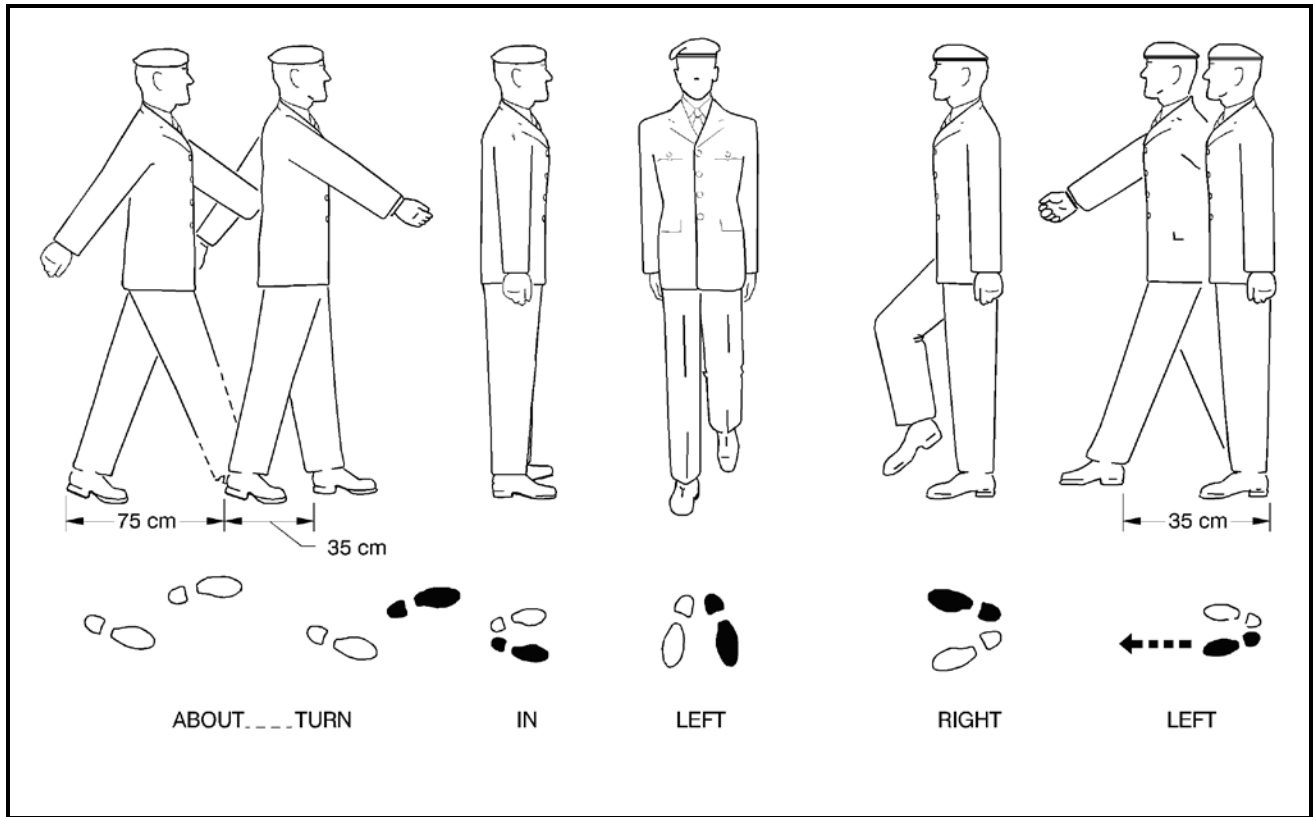

Figure 3-17 About Turn in Quick Time

123. On the command ABOUT TURN BY NUMBERS, SQUAD – ONE given as the right foot is forward and on the ground (Figure 3-17), squad members shall:

- take a half pace with the left foot, placing the foot flat on the ground naturally;
- bring the right foot in to the left, in a straight-leg manner above the ground, to the position of attention;
- simultaneously, cut the right arm down and the left in from the rear as the right foot comes in; and
- maintain the cadence.

124. On the command SQUAD – TWO, squad members shall:

- maintain the arms at the sides;

- b. pivot on the ball of the right foot to force the body through a turn of 90 degrees to the right;
- c. simultaneously, bend the left knee; and
- d. lower the leg smartly to the ground to assume the position of attention.

125. On the command SQUAD – THREE, squad members shall:

- a. maintain the arms at the sides;
- b. pivot on the ball of the left foot to force the body through a turn of 90 degrees to the right;
- c. simultaneously, bend the right knee; and
- d. lower the leg smartly to the ground to assume the position of attention.

126. On the command SQUAD – FOUR, squad members shall step off in quick time with a half pace with the left foot in the new direction.

127. On the command ABOUT – TURN, the four movements are combined and the cadence is maintained.

128. The timing is:

Count: LEFT – IN – LEFT – RIGHT – LEFT

Feet: LEFT – RIGHT – LEFT – RIGHT – LEFT

129. When a blank file of one person exists in a squad which is in line, the person shall commence to step short on the cautionary word of command RETIRE (ADVANCE), and execute the about turn with the new leading rank on the executive word TURN.

CHANGE TO QUICK TIME FROM SLOW TIME

130. On the command CHANGE TO QUICK TIME, QUICK – MARCH given as the right foot is forward and on the ground, squad members shall step forward with the left foot in quick time, swinging the right arm forward and the left arm to the rear.

CHANGE TO DOUBLE TIME FROM QUICK TIME

131. On the command CHANGE TO DOUBLE TIME, DOUBLE – MARCH given as the right foot is forward and on the ground, squad members shall step forward with the left foot in double time and with the arms in the position for marching in double time.

CHANGE TO QUICK TIME FROM DOUBLE TIME

132. On the command CHANGE TO QUICK TIME, QUICK – MARCH given as the right foot is forward and on the ground, squad members shall shorten the pace to the standard quick march length while completing four more paces in double time and then break into quick time.

CHANGE TO SLOW TIME FROM QUICK TIME

133. On the command CHANGE TO SLOW TIME, SLOW MARCH BY NUMBERS, SQUAD – ONE given as the right foot is forward and on the ground, squad members shall complete a half pace with the left foot, with the right arm swung forward and the left arm to the rear.

134. On the command SQUAD – TWO, squad members shall cut the arms to the sides as in the position of attention. The right foot is brought forward in double time, the right knee is bent and the right foot placed smartly

beside the left. As the right foot strikes the ground, the left foot is shot forward in a half pace just above the ground with the toe pointing down as in slow time.

135. On the command SQUAD – THREE, squad members shall complete the half pace with the left foot and carry on marching in slow time.

136. On the command CHANGE TO SLOW TIME, SLOW – MARCH, the three movements are combined. The timing is counted as “left, right, left” in double time.

CHANGE DIRECTION BY FORMING FROM THE HALT

137. A form changes the direction faced by a squad in line, while maintaining its formation (see Figure 3-18).

138. To change direction by forming from the halt to the halt, on the command AT THE HALT, CHANGE DIRECTION RIGHT, RIGHT – FORM:

- a. the leading person on the directing flank turns right;
- b. the remainder of the front rank makes a right incline; and
- c. the centre and rear rank stand fast.

139. On the command QUICK – MARCH:

- a. the leading person of the directing flank marches forward five paces and halts; and
- b. the remainder of the squad steps off, wheeling as necessary to regain their original position to the left of the directing flank, with each successive file halting in succession from right to left, facing the new direction.

140. To change direction by forming, from the halt to the mark time, on the command CHANGE – DIRECTION RIGHT, RIGHT – FORM:

- a. the leading person of the directing flank turns right;
- b. the remainder of the front rank makes a right incline; and
- c. the centre and rear rank stand fast.

141. On the command QUICK – MARCH:

- a. the leading person of the directing flank marches forward five paces and begins marking time on the fifth pace; and
- b. the remainder of the squad steps off, wheeling as necessary to regain their original position to the left of the directing flank, with each successive file marking time, in succession from right to left, facing the new direction.

142. On the command FOR – WARD or SQUAD – HALT, the squad acts as ordered.

143. Changing direction by forming to the left is executed as outlined above, except for “right” read “left”.

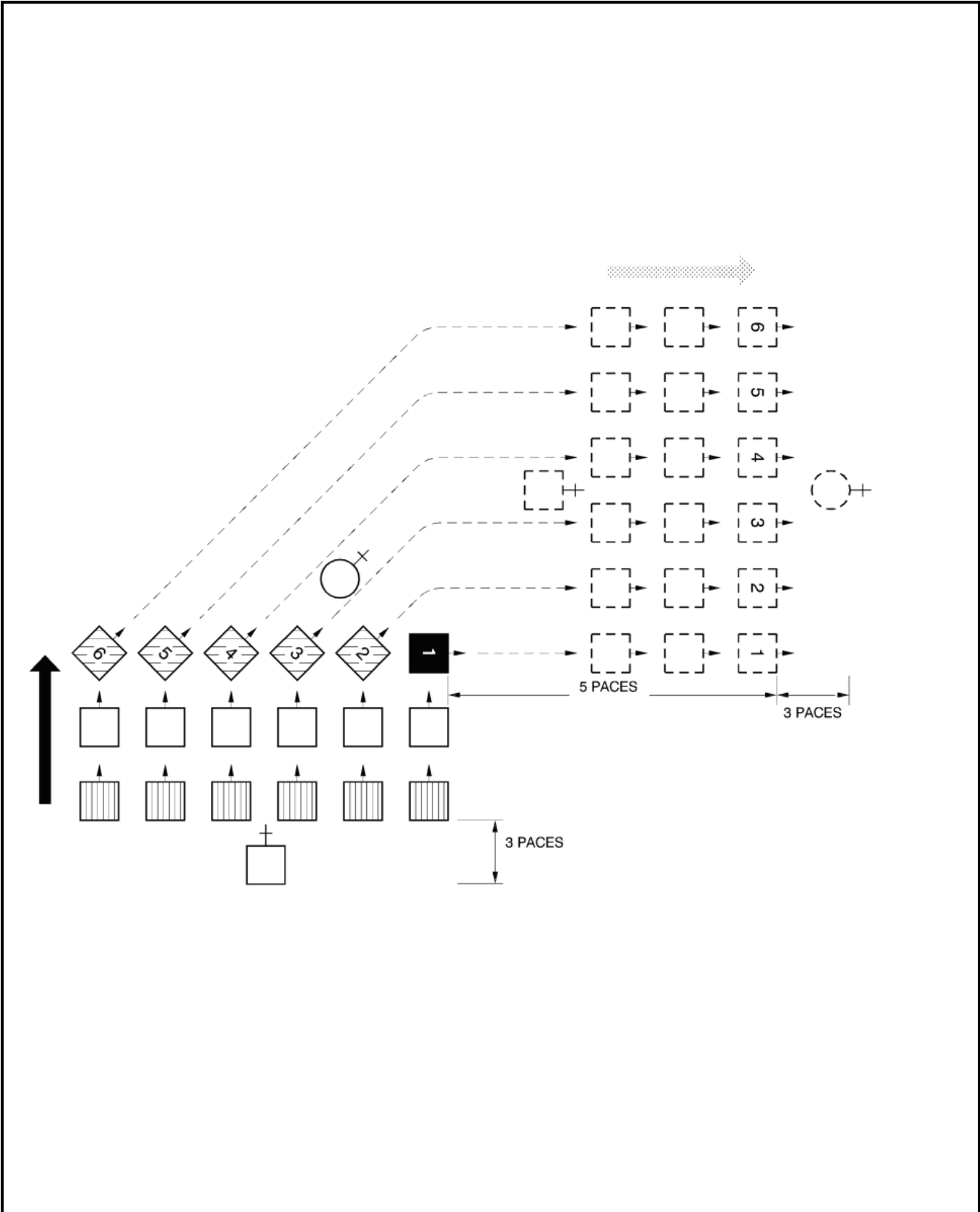

Figure 3- 18 Forming from the Halt

CHANGE DIRECTION BY FORMING ON THE MARCH

144. On the command AT THE HALT, CHANGE DIRECTION RIGHT, RIGHT – FORM given as the left foot is forward and on the ground:

- a. the leading person on the directing flank turns right, takes six paces forward and halts;
- b. simultaneously, the remainder of the front rank makes a right incline and steps off toward the new position in line with the right marker; and
- c. the centre and rear ranks wheel right to follow the leading individual in each file. Each file, as it reaches its position on the left of the directing flank facing the new direction, shall halt together in succession from the right.

145. On the command CHANGE DIRECTION RIGHT, RIGHT – FORM given as the left foot is forward and on the ground:

- a. the leading person of the directing flank turns right, takes five paces forward and marks time;
- b. simultaneously, the remainder of the front rank makes a right incline and marches toward its new position; and
- c. the centre and rear ranks wheel right, following the leading individual in each file. Each file, as it reaches its position on the left of the directing flank facing the new direction, shall mark time together in succession from the right.

146. On the command FOR – WARD or SQUAD – HALT, the squad acts as ordered.

147. Changing direction by forming to the left is executed as outlined above, except that the initial command is given as the right foot is forward and on the ground, and the movement is executed to the left.

148. The number of paces moved forward in the new direction on a form is governed by the direction in which the form is to be made. Five paces shall be taken when the form is executed to the left and six paces when the form is made to the right on the march so that the last pace forward is taken with the left foot.

FORM SQUAD IN LINE FROM THE HALT

149. The drill for forming a squad changes the formation of a squad marching in column (etc.) to that of line, while maintaining the squad's direction (see Figure 3-19).

150. To form a squad on its left, from the halt to the halt, on the command AT THE HALT, ON THE LEFT, FORM – SQUAD:

- a. the front left-hand person (the marker) stands fast; and
- b. the remainder of the squad makes a left incline.

151. On the command QUICK – MARCH:

- a. the front left-hand person (the marker) marches forward five paces and halts; and
- b. the remainder of the squad steps off, wheeling as necessary, each file taking up its new position to the left of the leading file, facing the same direction and halting together in succession from right to left.

152. To form a squad on its left from the halt to the mark time, on the command ON THE LEFT, FORM – SQUAD:

- a. the front left-hand person (the marker) stands fast; and
- b. the remainder of the squad makes a left incline.

153. On the command QUICK – MARCH:

- a. the front left-hand person (the marker) marches forward five paces and commences marking time; and
- b. the remainder of the squad steps off, wheeling as necessary, each file taking up its new position to the left of the leading file, facing the same direction and marking time together in succession from right to left.

154. On the command FOR – WARD or SQUAD – HALT, the squad acts as ordered.

FORM SQUAD IN LINE ON THE MARCH

155. On the command AT THE HALT, ON THE LEFT, FORM – SQUAD given as the right foot is forward and on the ground:

- a. the front left-hand person (the marker) continues to move forward five paces and halts; and
- b. the remainder of the squad executes a left incline, wheels to its position to the left of the leading file, each file halting together in succession from right to left.

156. On the command ON THE LEFT, FORM – SQUAD given as the right foot is forward and on the ground:

- a. the front left-hand person (the marker) continues to move forward five paces and marks time; and
- b. the remainder of the squad executes a left incline, wheels to its position to the left of the leading file, each file beginning to mark time together, in succession from right to left.

157. On the command FOR – WARD or SQUAD – HALT, the squad acts as ordered.

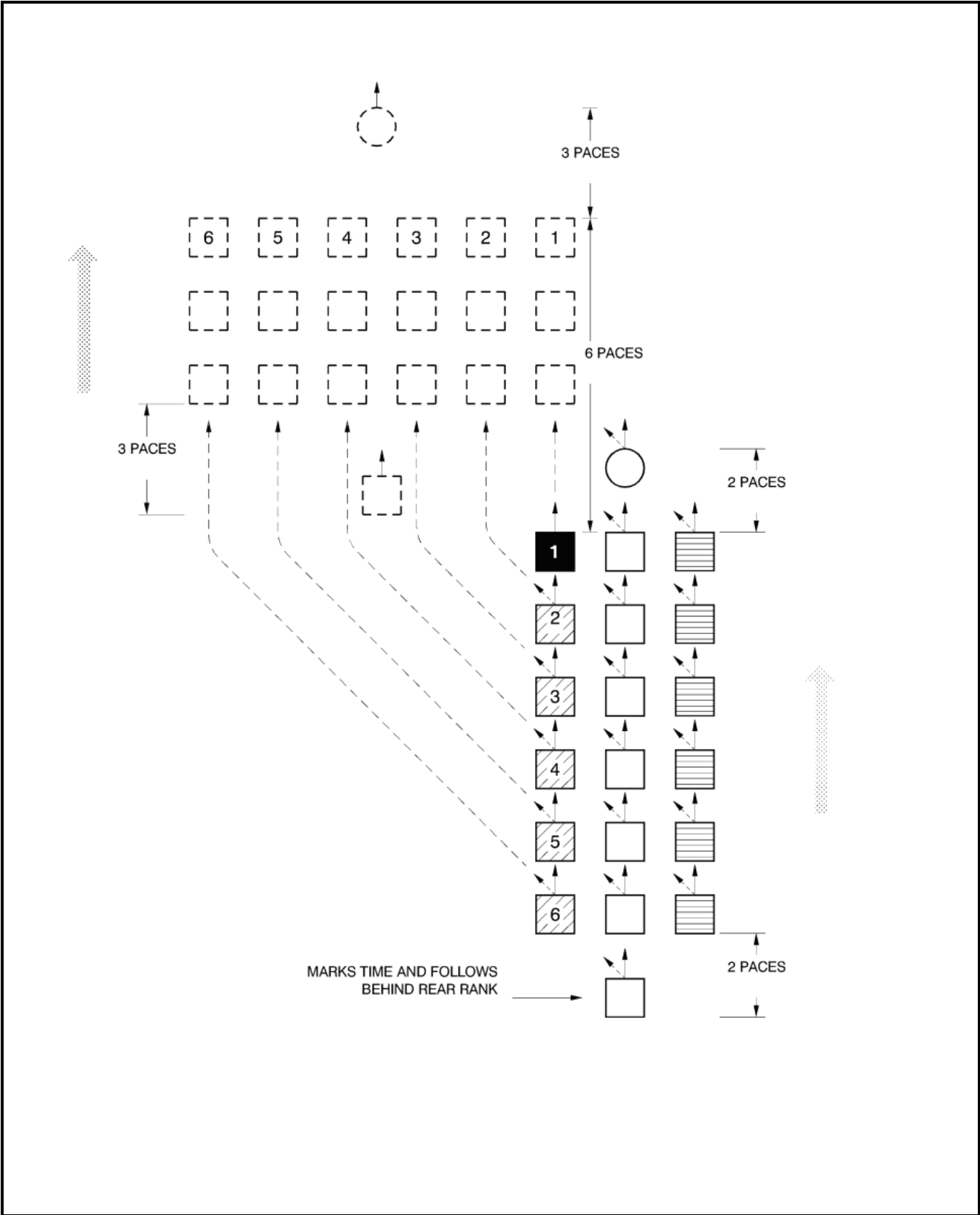

Figure 3- 19 Forming Squad from the Halt

SQUAD IN THREES FORMING SINGLE FILE FROM THE HALT

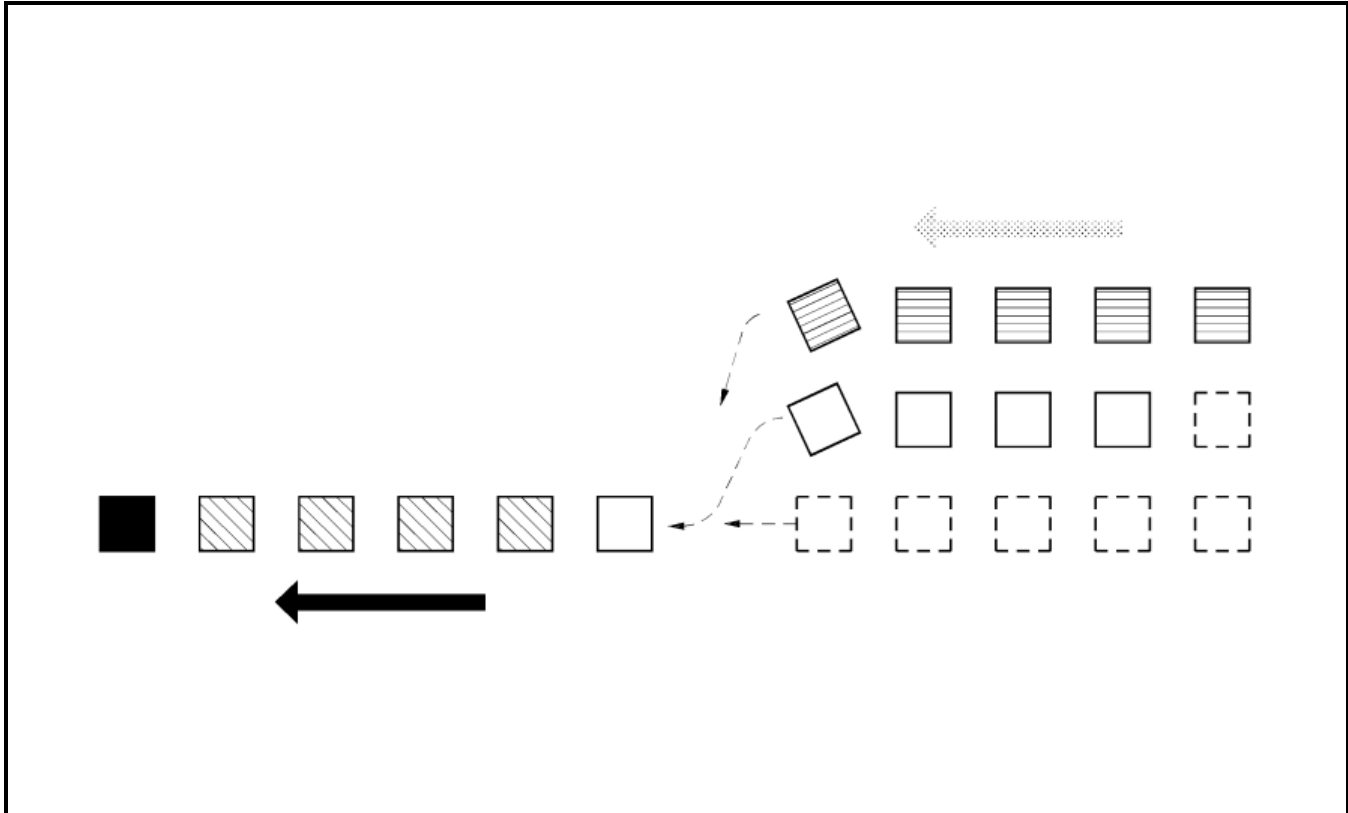

Figure 3- 20 Squad in Threes Forming Single File

158. On the command SINGLE FILE FROM THE LEFT (RIGHT), QUICK – MARCH:
- the directing flank marches off in single file in quick time (Figure 3-20); and
 - the remainder mark time. The leading person of the centre and non-directing flank execute a left (right) incline and lead off in single file when the file on their left (right) is clear.

SQUAD IN THREES FORMING SINGLE FILE ON THE MARCH

159. On the command SINGLE FILE FROM THE LEFT (RIGHT), REMAINDER MARK – TIME given as the right foot is forward and on the ground:
- the directing flank continues marching forward;
 - the remainder mark time; and
 - the leading person of the centre and non-directing flank execute a left (right) incline and lead off in single file when the file on their left (right) is clear.

SQUAD IN SINGLE FILE REFORMING THREES FROM THE HALT

160. On the command ON THE RIGHT (LEFT) REFORM THREES, REMAINDER QUICK – MARCH:
- the rank leading the single file stands fast; and
 - the remainder step off, reform three ranks and halt.

SQUAD IN SINGLE FILE REFORMING THREES ON THE MARCH

161. On the command ON THE RIGHT (LEFT), REFORM THREES, FRONT RANK MARK – TIME given as the right foot is forward and on the ground:

- a. the front rank marks time; and
- b. the remainder reform threes and mark time.

162. On the command FOR – WARD or SQUAD – HALT, the squad acts as ordered.

SQUAD IN LINE FORMING SINGLE FILE FROM THE HALT

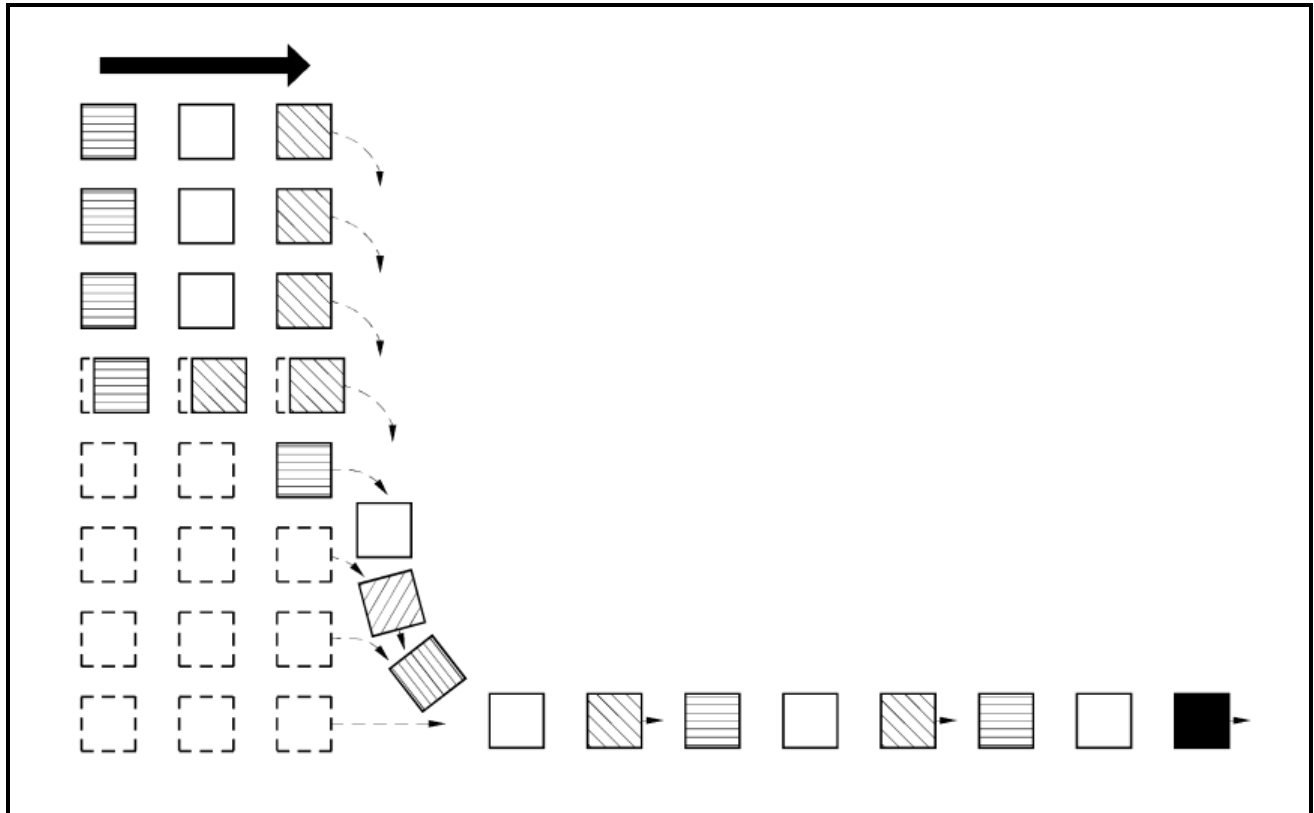

Figure 3-21 Squad in Line Forming Single File

163. On the command SINGLE FILE FROM THE RIGHT (LEFT), QUICK – MARCH:

- a. the file on the directing flank marches forward in single file in quick time (Figure 3-21); and
- b. the remainder mark time, lead off and wheel in single file following the file on their right (left).

SQUAD IN LINE FORMING SINGLE FILE ON THE MARCH

164. On the command SINGLE FILE FROM THE RIGHT (LEFT), REMAINDER MARK – TIME given as the right foot is forward and on the ground:

- a. the file on the directing flank continues marching forward; and
- b. the remainder mark time and then lead off in single file, stepping off with the left foot, when the file on their right (left) is clear.

SQUAD IN SINGLE FILE REFORMING LINE FROM THE HALT

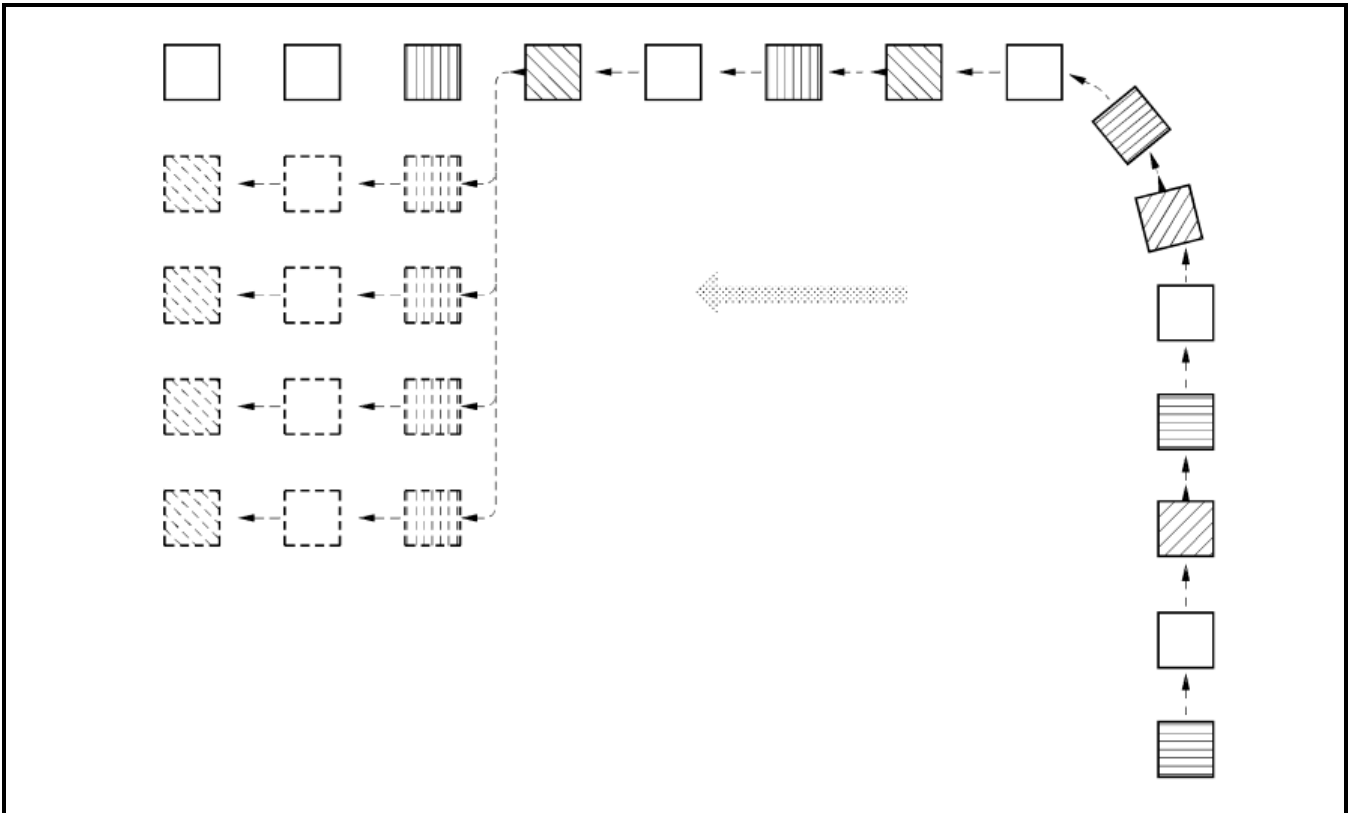

Figure 3- 22 Squad in Single File Reforming Line from the Halt

165. On the command ON THE LEFT (RIGHT), REFORM LINE, REMAINDER QUICK – MARCH:

- a. the leading file stands fast (Figure 3-22); and
- b. the remainder step off, reform line and halt.

SQUAD IN SINGLE FILE REFORMING LINE ON THE MARCH

166. On the command ON THE LEFT (RIGHT), REFORM LINE, LEADING FILE MARK – TIME given as the right foot is forward and on the ground:

- a. the leading file marks time; and
- b. the remainder reform line and mark time.

167. On the command FOR – WARD or SQUAD – HALT, the squad acts as ordered.

OPEN ORDER ON THE MARCH IN SLOW TIME

168. On the command OPEN – ORDER given as the right foot is forward and on the ground, squad members shall act as follows:

- a. when in two ranks:
 - (1) the front rank continues marching forward, and
 - (2) the rear rank marks time for two paces and then steps off with the left foot; and

- b. when in three ranks:
 - (1) the front rank continues marching forward,
 - (2) the centre rank marks time for two paces, and
 - (3) the rear rank marks time for four paces.

CLOSE ORDER ON THE MARCH IN SLOW TIME

169. On the command CLOSE – ORDER given as the right foot is forward and on the ground, squad members shall act as follows:

- a. when in two ranks:
 - (1) the front rank marks time for two paces and then steps off with the left foot, and
 - (2) the rear rank continues marching forward.
- b. when in three ranks:
 - (1) the front rank mark time for four paces,
 - (2) the centre rank mark time for two paces, and
 - (3) the rear rank continues marching forward.

CHAPTER 4
C7 RIFLE DRILL
SECTION 1
BASIC RIFLE DRILL

INTRODUCTION

1. **Preliminary Instruction.** Before commencing instruction, it is important that members of the squad be issued a rifle with the correct butt size and receive instruction in the names of the parts of the rifle and its care and maintenance (Figure 4-1-1). Safety precautions should be carried out at the commencement of arms drill lessons. Weapons should be fitted with a magazine and sling and the bolt should be in the weapon. Optical sights will not be removed for drill purposes.
2. **Drill Instruction.** Initial instruction shall be by numbers following the method outlined in Chapter 1. The squad should be in hollow square or single rank.
3. **Words of Command.** All movements on the march are made on successive beats of the left foot. Words of command are given as the left foot is forward and on the ground. Movements start the next time the left foot comes to the ground.
4. **Rifle Movements.** Unless stated otherwise, during the execution of rifle movements:
 - a. the sling is kept taut on the left-hand side of the magazine with the lower keeper 10 cm from the rear sling swivel;
 - b. the rifle is moved as quickly as possible between positions and kept close to the body;
 - c. the head, body and legs are maintained in the position of attention;
 - d. the fingers are kept close together;
 - e. the elbows are kept close to the body;
 - f. the disengaged hand is brought to the rifle by the shortest route and as quickly as possible and the same principle applies when returning the disengaged hand to the position of attention; and
 - g. the standard pause between all rifle and foot drill movements is observed.
5. **Resting the Squad.** During initial rifle drill instruction, it is sometimes necessary to hold a rifle movement for a considerable period of time while details are being explained. This is tiring for the squad members and will result in sloppy drill. To allow rest while other members of the squad are being corrected, the commands FRONT RANK (SQUAD, etc.) – REST; and SQUAD POSI – TION may be used. To rest the squad, the following procedures are to be used:
 - a. on the command FRONT RANK (SQUAD, etc.) – REST, the rifle butt is brought to the ground but the feet are not moved; and
 - b. on the command SQUAD, POSI – TION, the squad resumes the position they were in when ordered squad rest.

C7A2 RIFLE

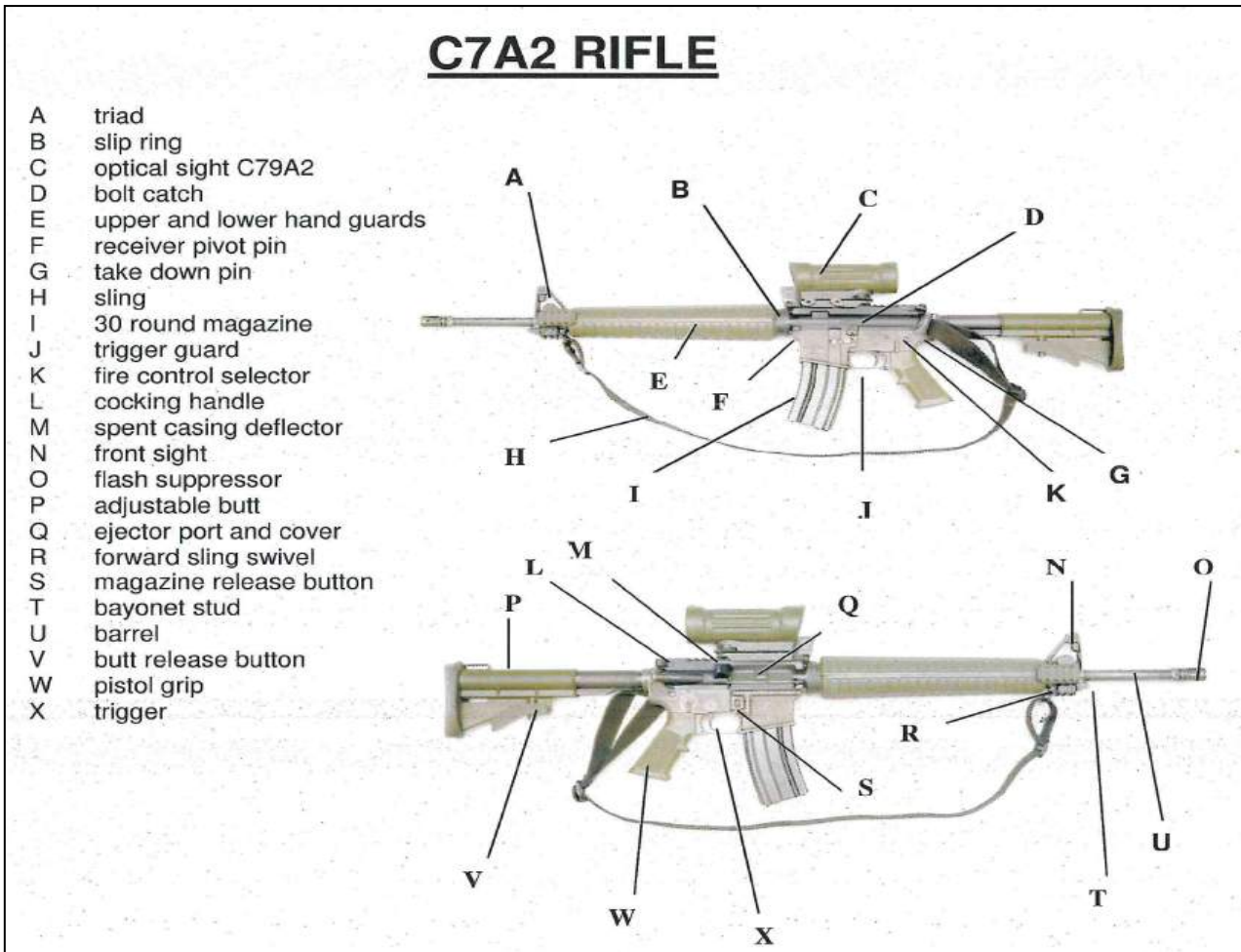

Figure 4-1-1 C7A2 Rifle

6. **Faults.** Constant checking for and correcting of faults is essential. Errors will be corrected immediately when they occur.

7. **Rifle/Carbine Drill.** Movements for rifle and carbine drill have been coordinated to ensure units armed with both carry out actions together.

ATTENTION

Figure 4-1-2 Position of Attention

8. The position of attention with the rifle is the same as detailed in Chapter 2, paragraph 3, except that the rifle is held with the right hand at the right side of the body (Figure 4-1-2).
9. To assume the position of attention, squad members shall:
 - a. grasp the rifle with the front sight in the palm of the right hand, fingers extended straight down the right side of the rifle with the thumb on the left side touching the seam of the trousers. The muzzle will be pulled back between the arm and the side of the body. The position of the right hand will not vary with the height of the individual, but the position of the right elbow will be either bent or straight. If the elbow is bent it will be held close to the body and to the rear;
 - b. place the butt on the ground with the rifle touching the boot, toe of the butt in line with the small toe of the right foot; and
 - c. keep the magazine square to the front.

STAND AT EASE FROM ATTENTION

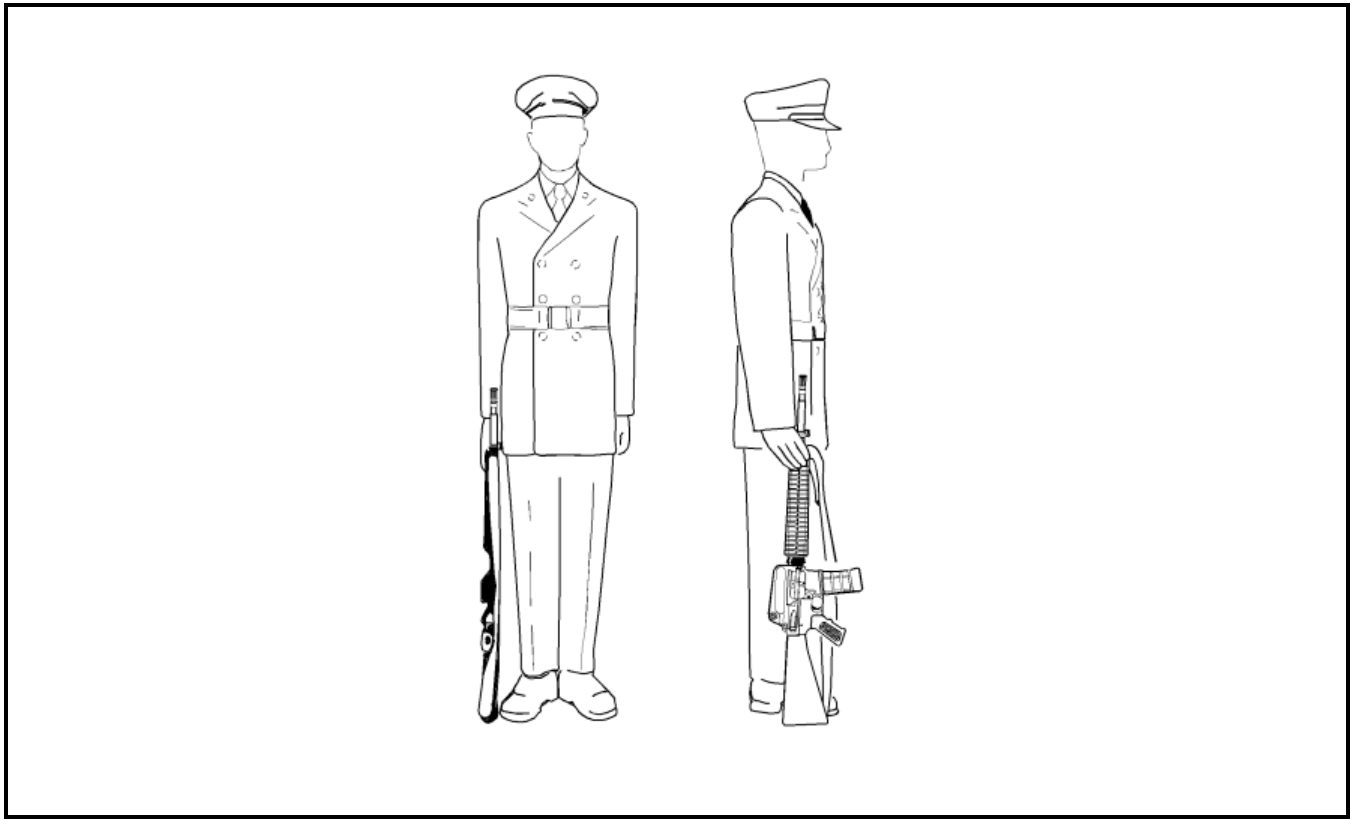
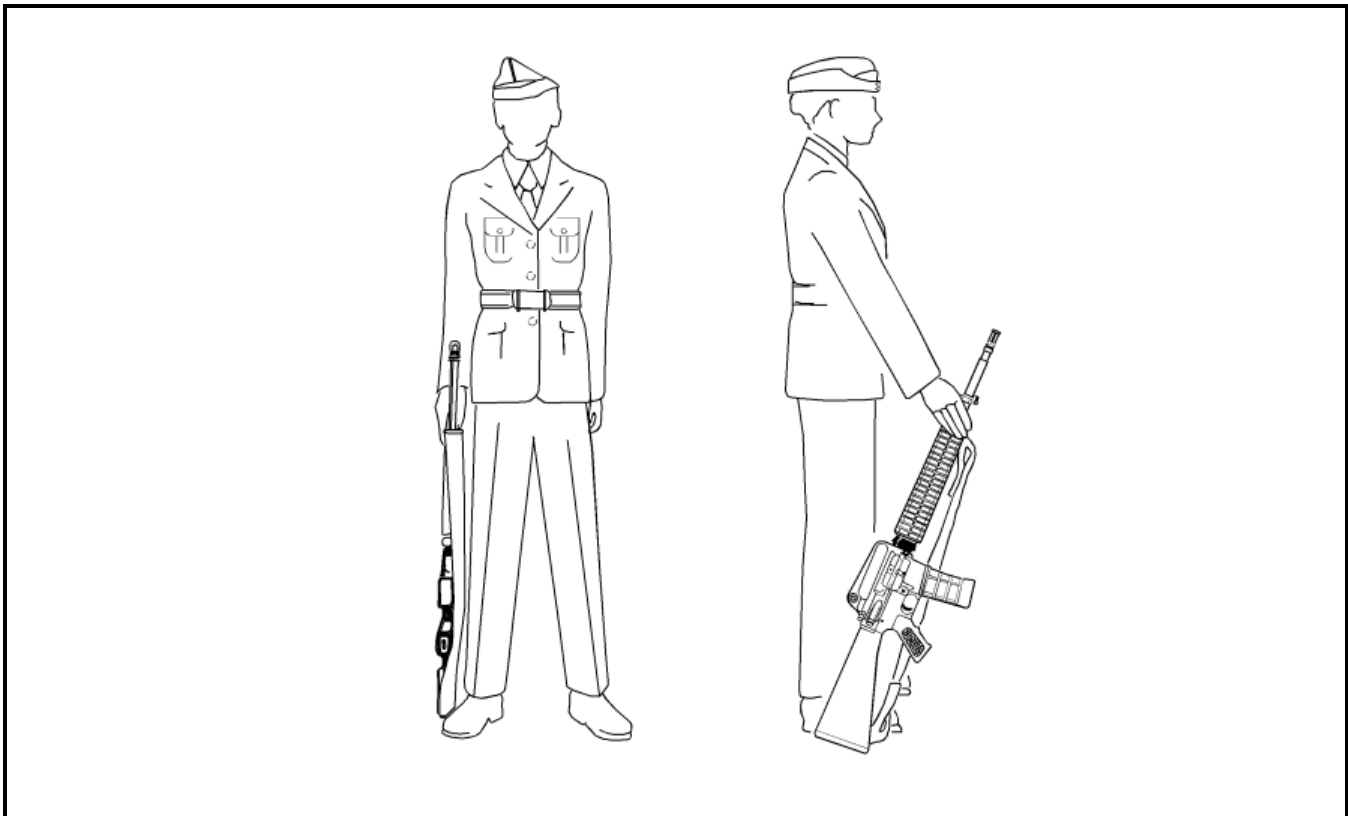

Figure 4- 1-3 Position of Stand at Ease

10. On the command STAND AT – EASE, squad members shall:
 - a. force the rifle directly to the front and to the full extent of the right arm, keeping the toe of the butt in contact with the ground and in line with the small toe of the right foot (Figure 4-1-3);
 - b. simultaneously, bend the left knee and place the left foot smartly on the ground 25 cm to the left; and
 - c. keep the left arm straight at the side.

STAND EASY FROM STAND AT EASE

Figure 4- 1-4 Position of Stand Easy from Stand at Ease

11. On the command STAND – EASY, squad members shall:
 - a. with a quick movement of the right arm, bring the muzzle of the rifle to the centre of the body by pivoting the rifle on the toe of the butt so the base of the magazine is pointing to the left (Figure 4-1-4);
 - b. simultaneously, strike and grasp the flash suppressor (when bayonets are fixed, the handle of the bayonet) with the palm of the left hand, thumb in rear and fingers in front of the flash suppressor, fingers together pointing down and to the right in a straight line from the elbow; and
 - c. after observing a standard pause, relax the body.

STAND AT EASE FROM STAND EASY

12. On the command SQUAD, the squad shall assume the position of stand at ease.

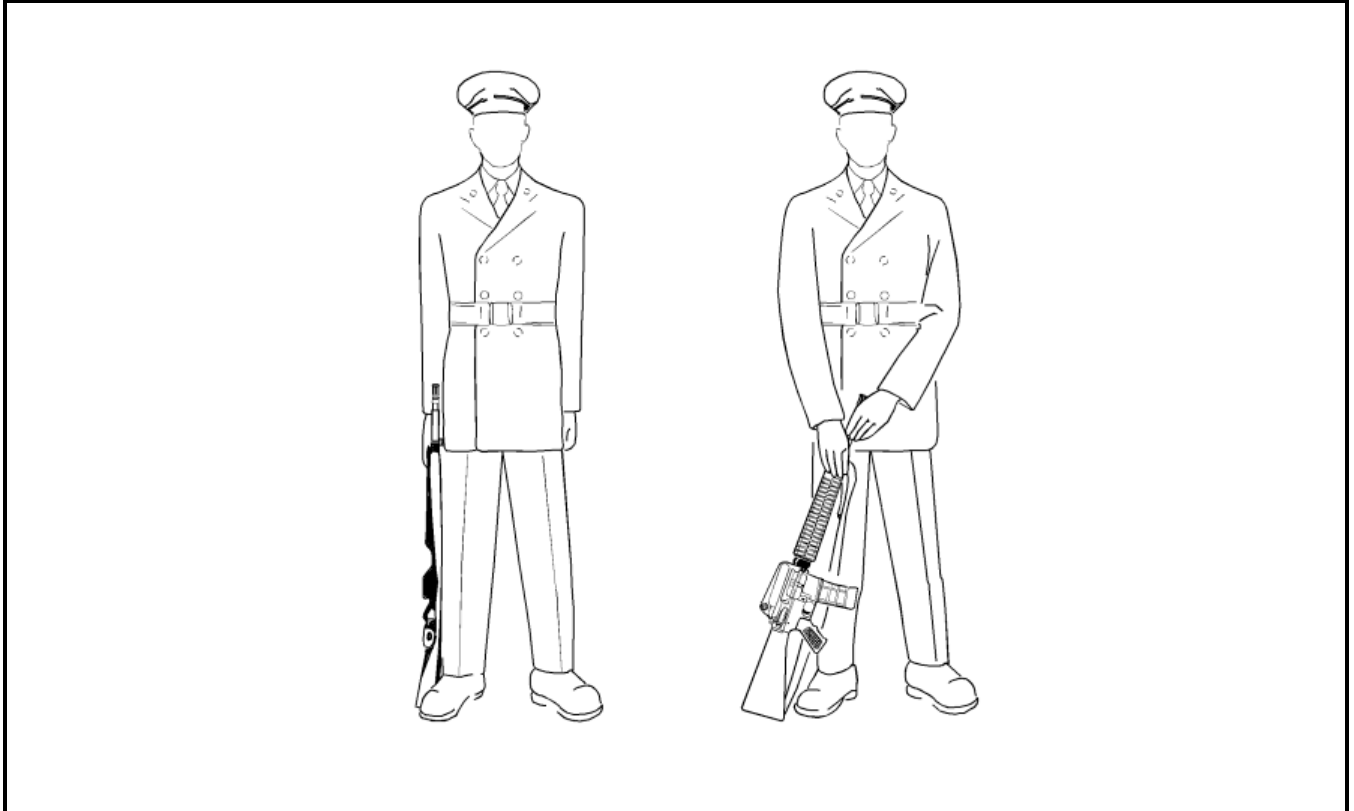
ATTENTION FROM STAND AT EASE

13. On the command ATTEN – TION, squad members shall:
 - a. bend the left knee and bring the left foot to the position of attention, keeping the left arm at the side; and
 - b. with a swift motion, simultaneously force the rifle to the right side, keeping the butt in contact with the ground and the foot, and assume the position of attention.

SHORT TRAIL ARMS

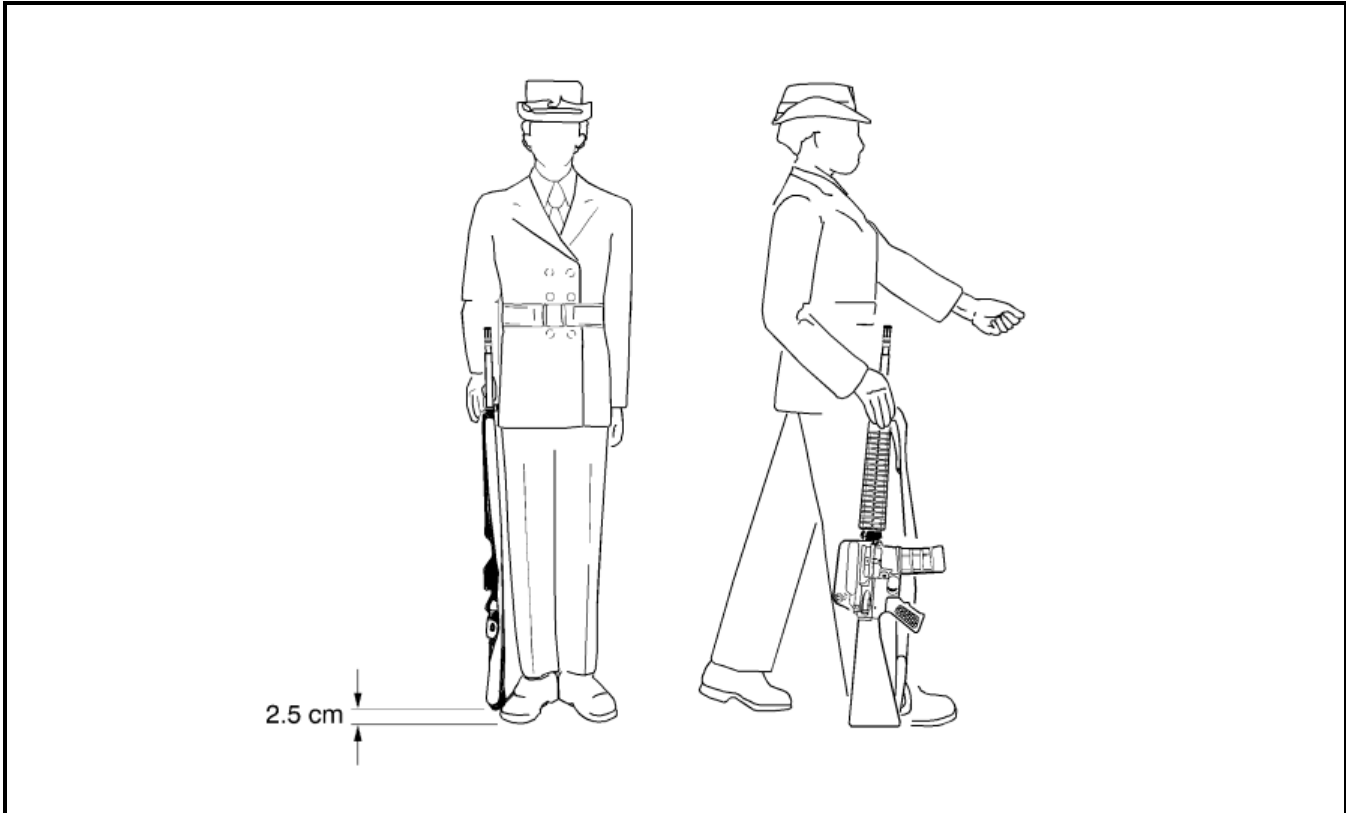
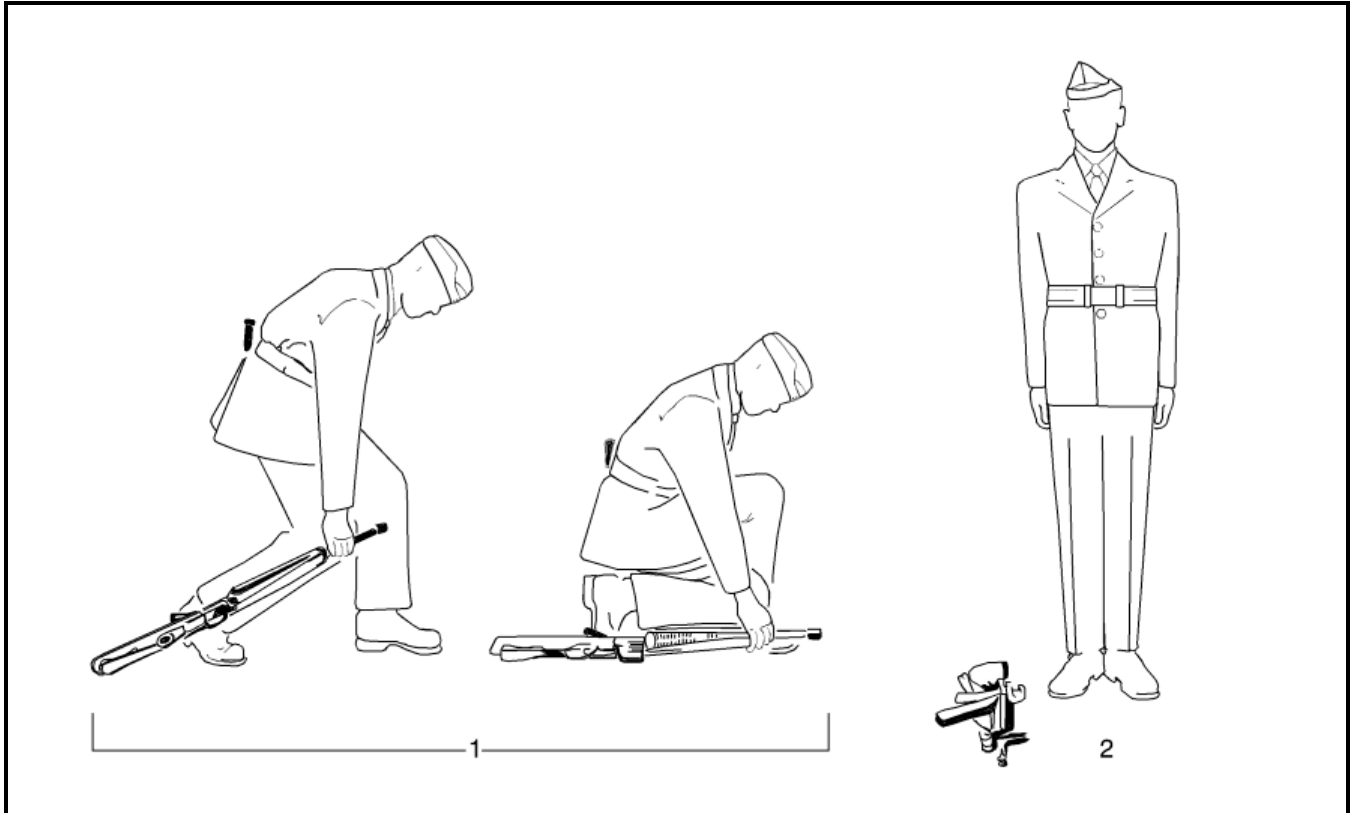

Figure 4- 1-5 Short Trail

14. The short trail is used when marching the squad short distances or during dressing when squad members are required to move.
15. On the command **SHORT TRAIL – ARMS** given only when the squad is in the position of attention, squad members shall (Figure 4-1-5):
 - a. bend the right arm and raise the butt of the rifle 2 cm from the ground; and
 - b. keep the rifle vertical and close to the body.
16. . On the command **AT THE SHORT TRAIL, QUICK – MARCH**, simultaneously with the detail in paragraph 15 above, step off with the left foot.
17. On the command **SQUAD – HALT**, the squad shall halt as ordered and, as the right knee is straightened, lower the rifle to the attention position.
18. When a squad is at the order arms position and the command **QUICK – MARCH** is given, the squad shall automatically adopt the short trail position as they step off with the left foot.

GROUND ARMS**Figure 4-1-6 Ground Arms**

19. When a squad is formed in ranks, the ground arms command is used when it is necessary to move the squad without arms. Ground arms may be ordered only when a squad is at the open order. Care must be taken not to kick or step on arms when they are grounded.
20. On the command **GROUND ARMS BY NUMBERS, SQUAD – ONE**, squad members shall:
- take a half pace forward with the left foot and, by bending the knees, adopt a squatting position while simultaneously lifting the rifle and forcing the butt to the rear so that the weapon is parallel to the ground (Figure 4-1-6);
 - keeping the right arm straight, lay the rifle on the ground with the magazine to the right and the muzzle pointing straight to the front, with the front sight in line with the toe of the left foot;
 - keep the shoulders square to the front and look down at the rifle; and
 - keep the left arm straight against the body and hip.
21. On the command **SQUAD – TWO**, squad members shall:
- release the rifle; and
 - assume the position of attention by standing erect, bending the left knee and bringing the left foot smartly back to the right foot.
22. On the command **GROUND – ARMS**, the two movements are combined. A standard pause shall be observed between the movements.

TAKE UP ARMS

23. On the command TAKE UP ARMS BY NUMBERS, SQUAD-ONE, squad members shall:
 - a. take a half pace forward with the left foot and squat with the weight of the body on the right foot;
 - b. look down and grasp the rifle at the front sight with the right hand; and
 - c. keep the left arm straight against the body and hip.
24. On the command SQUAD – TWO, squad members shall assume the position of attention by:
 - a. standing erect, bending the left knee and bringing the left foot smartly back to the right; and
 - b. simultaneously, rotating the rifle to the left, bringing the magazine to the front and placing the butt of the rifle flat on the ground.
25. On the command TAKE UP – ARMS, the two movements are combined. A standard pause shall be observed between the movements.

SHOULDER ARMS FROM THE ORDER

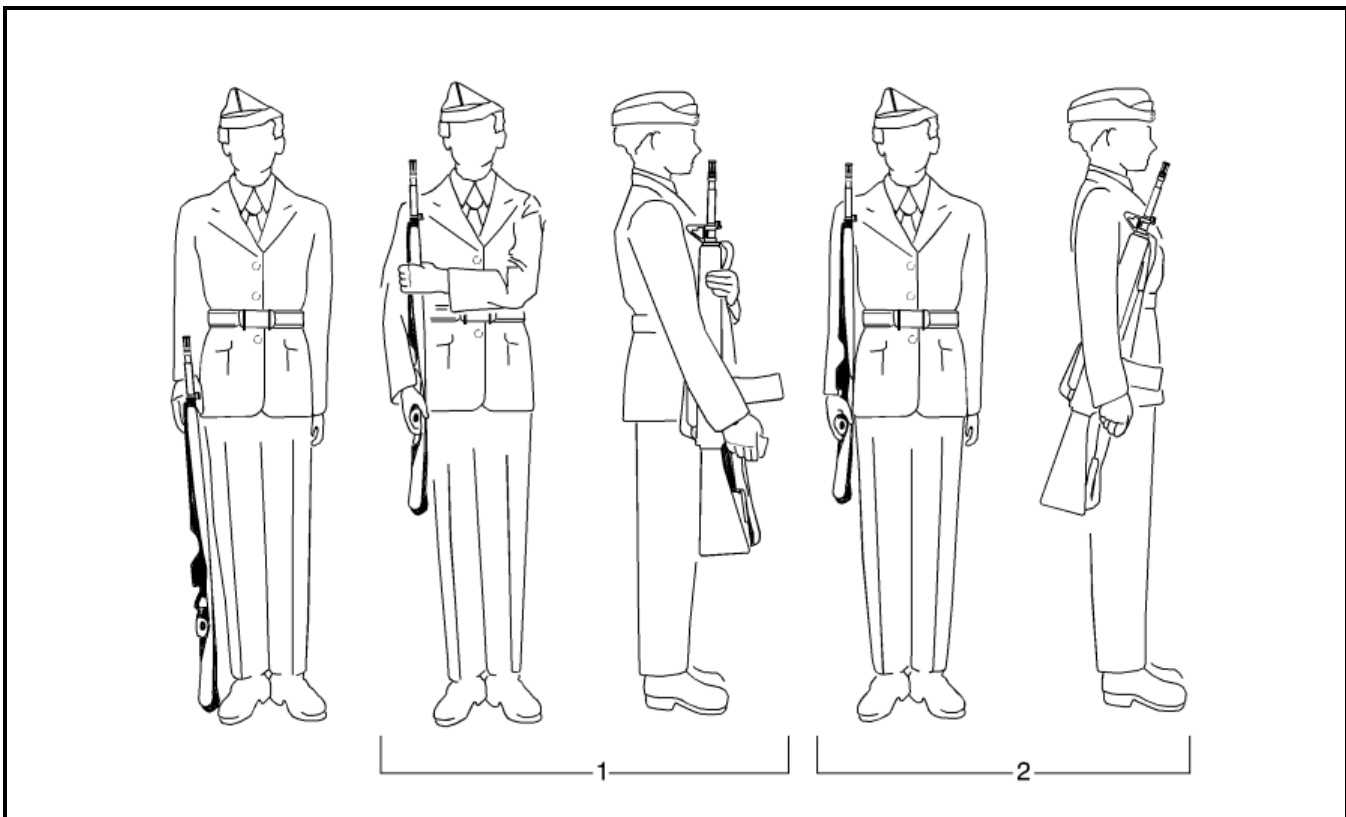

Figure 4-1-7 Shoulder Arms from the Order

26. The position of shoulder arms is the main position for carrying the rifle on the march (Figure 4-1-7).
27. On the command SHOULDER ARMS BY NUMBERS, SQUAD – ONE, squad members shall:
 - a. throw the rifle vertically up the right side with a flick of the right wrist, keeping the elbow as still as possible, release the rifle before the right hand reaches the waist, straighten the right arm, and strike and grasp the pistol grip with the right hand with the knuckles to the right, thumb around the pistol grip;

- b. simultaneously, bring the left forearm horizontally across the body to strike and grasp the handguard with an all-round grip of the left hand and force the rifle into the right shoulder; and
 - c. keep the rifle vertical to the ground.
28. On the command SQUAD – TWO, squad members shall assume the position of attention by:
- a. cutting the left hand to the side by the shortest route; and
 - b. forcing the rifle back until the thumb of the right hand is in line with the trouser seam.
29. On the command SHOULDER – ARMS, the two movements are combined. A standard pause shall be observed between movements.

ORDER ARMS FROM THE SHOULDER

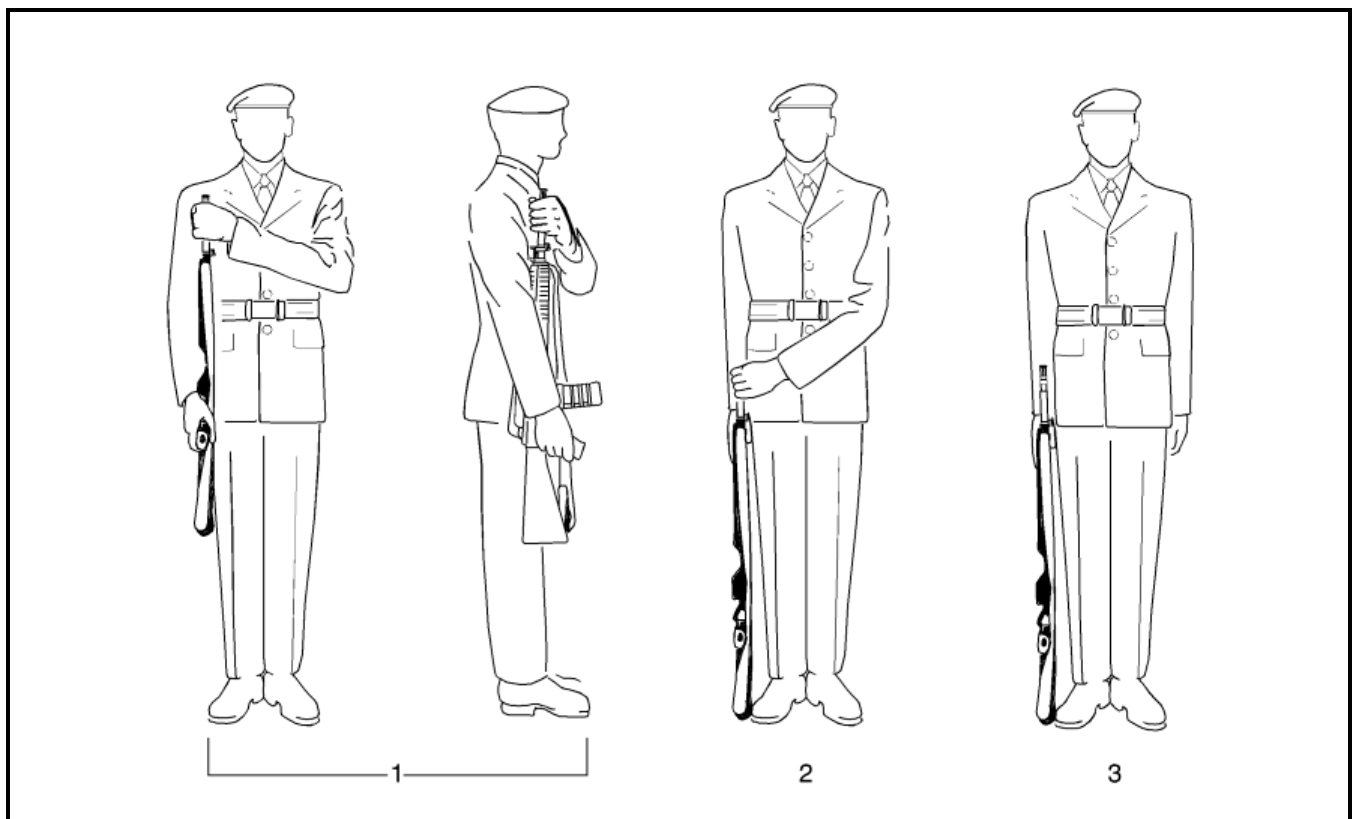

Figure 4-1-8 Order Arms from the Shoulder

30. On the command ORDER ARMS BY NUMBERS, SQUAD – ONE, squad members shall:
- a. retain the grip with the right hand, force the left hand across the body to strike and grasp the barrel immediately below the flash suppressor with an all-round grip, and keep the left elbow close to the body (Figure 4-1-8);
 - b. simultaneously, force the butt forward so the rifle is held vertically to the ground; and
 - c. when the bayonet is on the rifle, the left hand will grasp the bayonet handle with an all-round grip.
31. On the command SQUAD – TWO, squad members shall:

- a. release the pistol grip and force the rifle down the right side with the left hand until the butt is 2 cm from the ground; and
- b. simultaneously, seize the rifle with the front sight in the palm of the right hand, with the fingers extended straight down the right side of the rifle and the thumb on the left.

32. On the command SQUAD – THREE, squad members shall cut the left hand to the side, lower the rifle to the ground and assume the position of attention.

33. On the command ORDER – ARMS, the three movements are combined. A standard pause shall be observed between movements.

DRESSING A SQUAD

34. When dressing a squad on parade with rifles, the squad may be at the order or shoulder arms position.

35. On the command RIGHT (LEFT) – DRESS, the movement is executed normally except that the left arm is raised as the head is turned in the required direction.

36. On the command SHOULDER (ELBOW) DRESSING, RIGHT (LEFT) – DRESS, the movement is executed normally.

ORDERING A SQUAD WITH RIFLES ON PARADE

37. The squad shall assemble in three ranks at the edge of the parade ground and stand at ease. The marker detailed by the instructor shall take up position as the right-hand person of the front rank and stand at ease.

38. On the command MARKER, the marker shall:

- a. come to attention and observe the standard pause;
- b. shoulder arms and observe the standard pause;
- c. march to a position three paces in front of and facing the instructor and halt; and
- d. remain at the shoulder.

39. After the marker has halted, the instructor shall turn right and move to a position three paces front and centre of where the squad will be fallen in.

40. On the command FALL – IN the squad shall:

- a. come to attention and observe the standard pause;
- b. shoulder arms and observe the standard pause;
- c. march onto the parade ground and halt on the left of and covering off the marker; and
- d. remain at the shoulder.

41. The instructor shall then proceed as required, i.e., right dress, eyes front, order arms, stand at ease.

42. This movement may be executed with the rifles held at the short trail position if the instructor so orders.

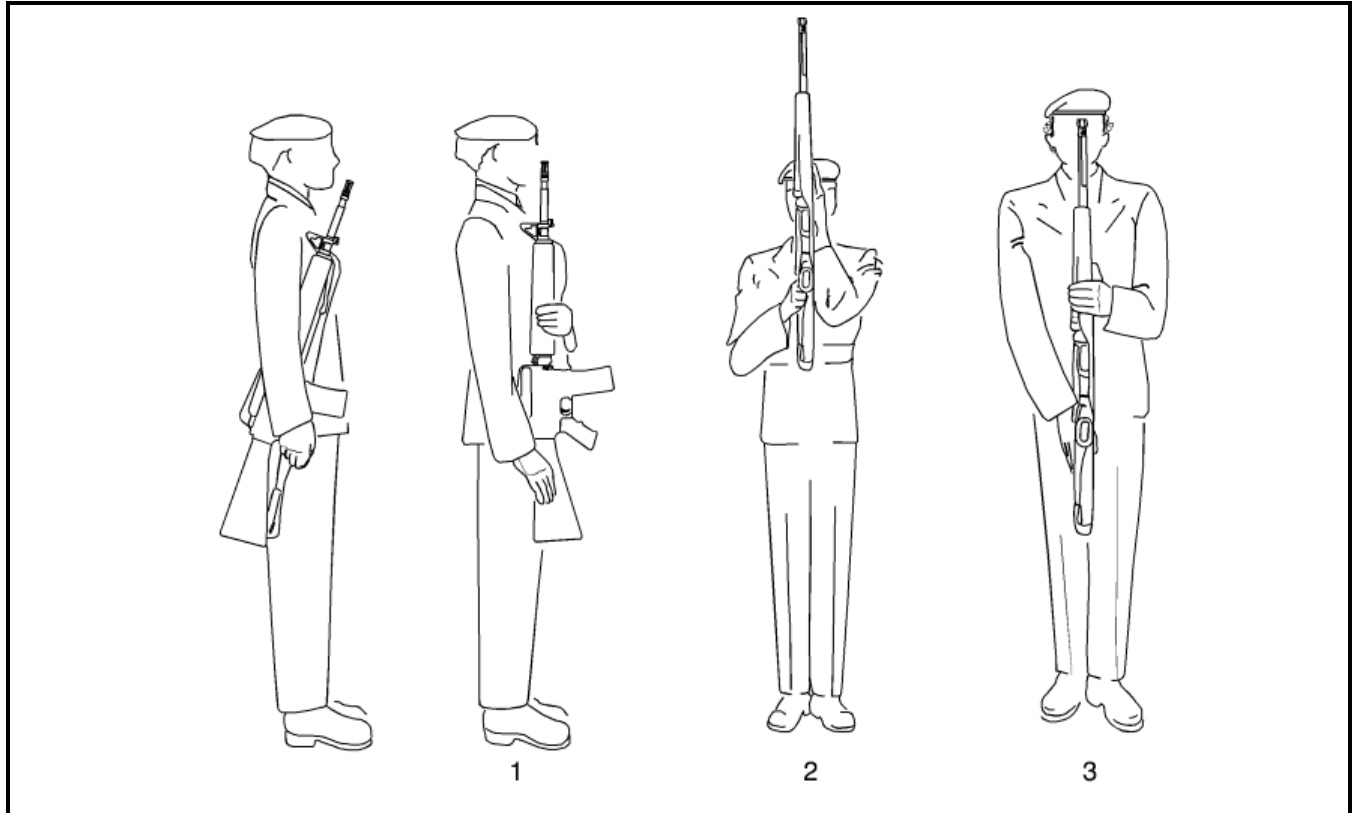
PRESENT ARMS FROM THE SHOULDER**Figure 4- 1-9 Present Arms from the Shoulder**

43. The present arms is a ceremonial salute (Figure 4-1-9). On the command **PRESENT ARMS BY NUMBERS, SQUAD – ONE**, squad members shall:
- with the right hand, flick the rifle up vertically 10 cm and then strike and grasp the small of the butt with the thumb on the left and the fingers together on the right;
 - simultaneously, with the left hand, strike and grasp the rifle at the handguard, the fingers curled around the handguard, and the left forearm close to the body and parallel to the ground; and
 - keep the right shoulder from moving backwards and move both hands simultaneously.
44. On the command **SQUAD – TWO**, squad members shall:
- close the fingers and thumb of the right hand around the small of the butt and force the rifle up to a vertical position in the centre of the body with the magazine facing the front. The top of the magazine is level with the throat and the rear sight is 10 cm from the body;
 - simultaneously, as the rifle reaches the central position, remove the left hand from the handguard, straighten the fingers and thumb and strike the forearm, wrist, palm and fingers against the rifle so that the slip ring rests in the palm, the elbow is forced into the side of the butt and the tip of the thumb is in line with the mouth; and
 - keep the rifle vertical on its way up, the left forearm into the rifle and the right elbow against the waist.
45. On the command **SQUAD – THREE**, squad members shall:
- straighten the right arm down the centre of the body thus lowering the rifle to a vertical position 10 cm from the body. The right forearm rests in the groin, the fingers of the right hand straightened down the right side of the butt and the thumb down the left;

- b. simultaneously, remove the left forearm from the rifle and with the left elbow into the side, strike and grasp the handguard, with the forearm horizontal, fingers closed around the front of the rifle, thumb vertical up the left side, wrist straight and little finger touching the magazine housing; and
- c. at the same time, bend the right knee and place the right foot smartly on the ground with the instep against the heel of the left foot; feet at an angle of 30 degrees.

46. Common faults to watch for are:

- a. Pushing the rifle upward before starting downwards.
- b. Left hand too high on the handguard.
- c. Weight of the body going back on the right foot.
- d. Increasing the angle between the feet, thereby dragging the shoulder backwards.
- e. Rifle too close to the body.

47. On the command PRESENT – ARMS, the three movements are combined. A standard pause shall be observed between the movements.

SHOULDER ARMS FROM THE PRESENT

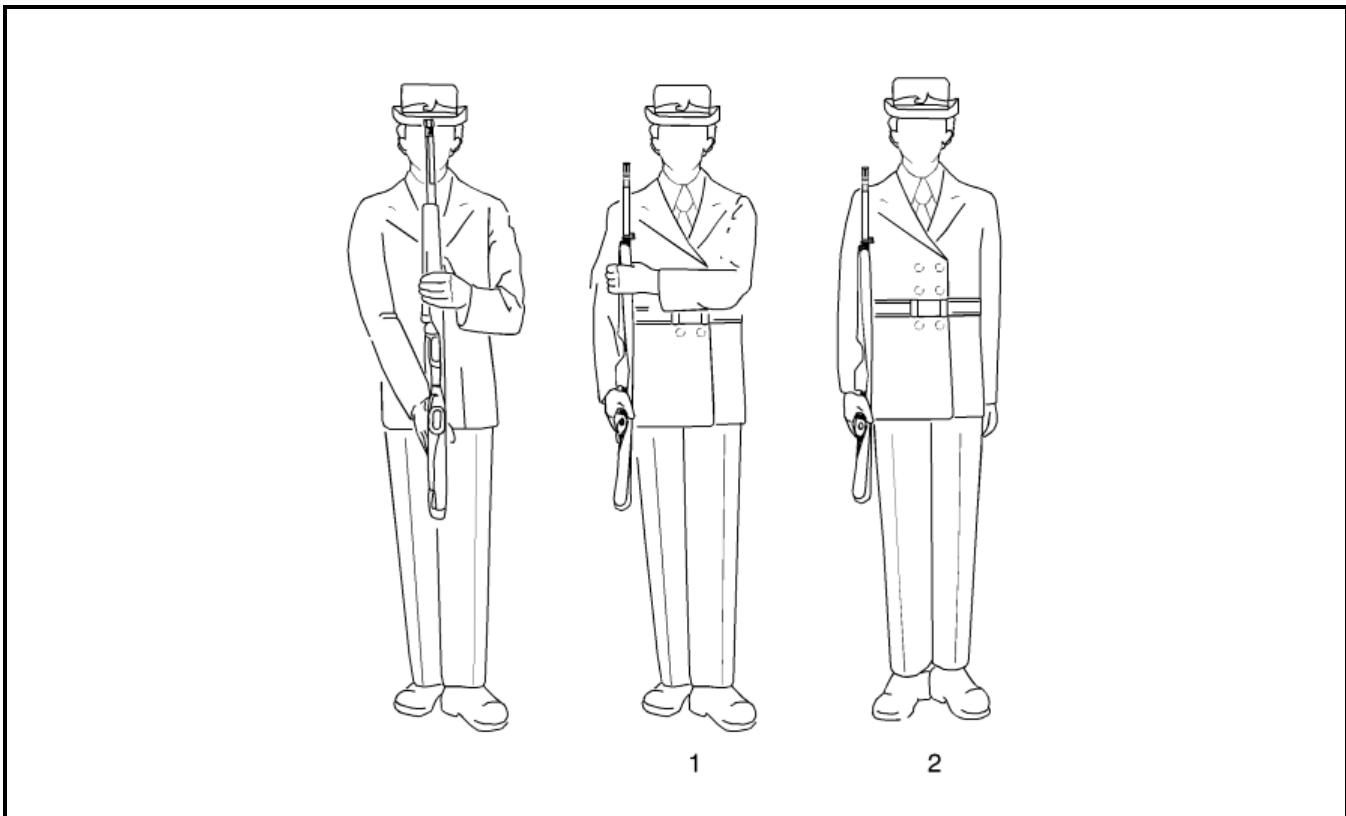

Figure 4-1-10 Shoulder Arms from the Present

48. On the command SHOULDER ARMS BY NUMBERS, SQUAD – ONE, squad members shall:
- a. force the rifle to the right side of the body as for the first position of the shoulder arms movement (Figure 4-1-10); and
 - b. simultaneously, strike and grasp the pistol grip with the right hand.

49. On the command SQUAD – TWO, squad members shall:
- bend the right knee and bring the right foot to the position of attention;
 - simultaneously, cut the left hand to the side; and
 - move the rifle back until the thumb of the right hand is in line with the trouser seam.
50. On the command SHOULDERS – ARMS, the two movements are combined. The standard pause shall be observed between the movements.

FIX BAYONETS

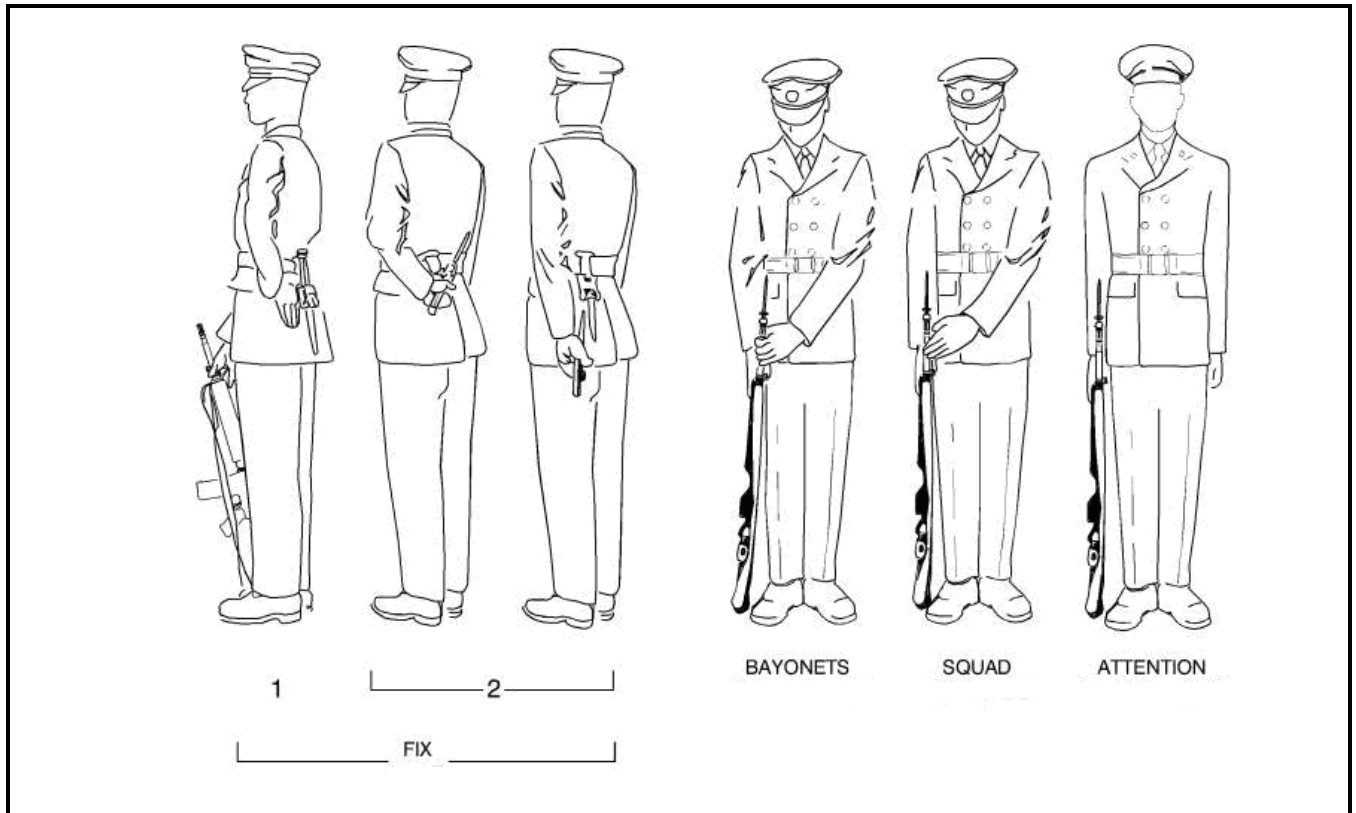

Figure 4- 1-11 Fix Bayonets

51. The squad shall be at the open order when fixing and unfixing bayonets.
52. On the command SQUAD WILL FIX BAYONETS BY NUMBERS, SQUAD – ONE, squad members shall:
- force the rifle out to the full extent of the right arm as for the position of stand at ease (Figure 4-1-11); and
 - simultaneously, grasp the bayonet handle with the thumb around the ring and the fingers extended on the handle.
53. On the command SQUAD – TWO, squad members shall:
- rotate the bayonet anti-clockwise; and
 - withdraw the bayonet by straightening the left arm, the bayonet being held along the left buttock, not visible from the front, and the fingers extended down the side of the bayonet handle with the thumb around the ring of the bayonet.

54. On the command SQUAD WILL FIX BAYONETS – FIX, the two movements are combined.
55. On the command BAYONETS BY NUMBERS, SQUAD – ONE, squad members shall:
 - a. lower the head to look directly at the muzzle of the rifle; and
 - b. simultaneously, bring the bayonet between the body and the arm and fix the bayonet on the rifle by first fitting the bayonet ring over the muzzle and then fitting the groove in the bayonet handle over the bayonet stud on the rifle.
56. On the command SQUAD – TWO, squad members shall push the bayonet down until the catch engages.
57. On the command SQUAD, BAYONETS, the two movements are combined. A standard pause shall be observed between the movements.
58. On the command SQUAD, squad members shall open the palm of the left hand and strike the handle of the bayonet, fingers and thumb together and extended in continuation of the line of the arm, thumb below the cross piece (guard) of the bayonet.
59. On the command SQUAD, ATTEN – TION, squad members shall:
 - a. pull the rifle to the right side; and
 - b. cut the left arm to the left side and raise the head to assume the position of attention.

NOTE

Units of The Royal Regiment of Canadian Artillery do not fix bayonets when on guard or other routine parades. On such occasions bayonets will be carried, but will not be fixed. In the case of special ceremonial parades, i.e., Guards of Honour for Royal personages, separate instructions will be issued by the chain of command.

UNFIX BAYONETS

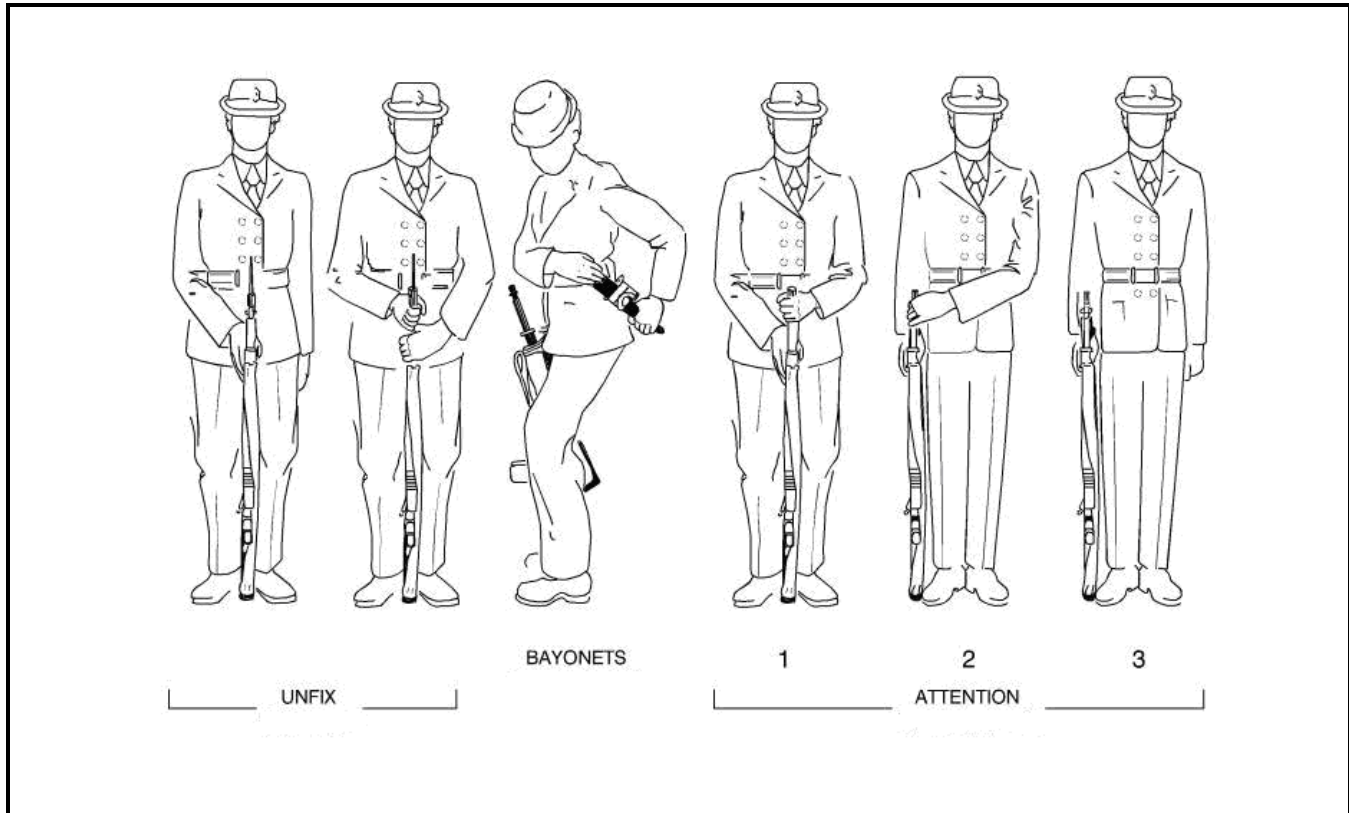

Figure 4- 1-12 Unfix Bayonets

60. On the command SQUAD WILL UNFIX BAYONETS BY NUMBERS, SQUAD – ONE, squad members shall:
- lift the rifle over the right instep with the right hand and place the butt flat on the ground between the feet so the heel of the butt is forced into the angle formed by the feet (Figure 4-1-12);
 - grasp the rifle between the knees, which shall be slightly bent; and
 - strike and grasp the rifle with the left hand immediately below the bayonet handle with the thumb and the forefinger pressing in on the bayonet catch.
61. On the command SQUAD – TWO, release the rifle with the right hand and grasp the bayonet handle with an upward movement, forcing the bayonet ring just clear of the rifle barrel. Keep the blade edge to the front and ensure that the angle of the bayonet does not change.
62. On the command SQUAD WILL UNFIX BAYONETS – UNFIX, the movements are combined. A standard pause shall be observed between the movements.
63. On the command BAYONETS BY NUMBERS, SQUAD – ONE, squad members shall:
- with a flick of the right wrist, turn the bayonet over to the left so that the flat of the blade strikes the belt;
 - grasp the scabbard with the left hand, tilting the scabbard and inserting the point of the bayonet into the mouth of the scabbard; and
 - simultaneously, bend the head downward and to the left to look at the scabbard.
64. On the command SQUAD – TWO, squad members shall:

- a. force the bayonet fully home in the scabbard;
 - b. keep the left elbow straight to the rear;
 - c. keep the right elbow close to the body; and
 - d. keep the fingers of the right hand closed and extended downward over the bayonet handle.
65. On the command SQUAD, BAYONETS, the two movements are combined. A standard pause shall be observed between the movements.
66. On the command ATTENTION BY NUMBERS, SQUAD – ONE, squad members shall:
- a. grasp the rifle with the right hand as for the position of attention;
 - b. simultaneously, release the scabbard with the left hand and strike and grasp the rifle barrel below the flash suppressor; and
 - c. turn the head and eyes to the front.
67. On the command SQUAD – TWO, squad members shall:
- a. lift the rifle over the right instep;
 - b. stand up; and
 - c. simultaneously, with the left hand, guide the rifle to the position of attention, steadying the rifle in the vertical position, fingers extended and thumb behind the muzzle.
68. On the command SQUAD – THREE, squad members shall cut the left hand and arm to the side assuming the position of attention.
69. On the command SQUAD, ATTEN – TION, the three movements are combined. A standard pause shall be observed between the movements.

EXAMINE ARMS FROM THE ORDER

Figure 4- 1-13 Examine Arms from the Order

70. The squad shall be in the open order when examining arms.
71. On the command FOR INSPECTION EXAMINE ARMS BY NUMBERS, SQUAD – ONE, squad members shall:
- take a half pace directly forward with the left foot (Figure 4-1-13), keeping the head, shoulder and body square to the front;
 - throw the rifle up and forward with the right hand to an angle of 45 degrees, grasp the handguard immediately in front of the magazine with the left hand, the sling in the palm of the left hand; and
 - with the right hand, grasp the pistol grip, the right forefinger outside the trigger guard and the butt forced into the side between the right forearm and the body.
72. On the command SQUAD – TWO, squad members shall remove the right hand from the pistol grip and grasp the cocking handle with the index and middle fingers.
73. On the command SQUAD – THREE, squad members shall, with the right hand:
- pull the working parts to the rear; and
 - return the cocking handle to its normal position.
74. On the command SQUAD – FOUR, squad members shall return the right hand to the pistol grip, right forefinger along the trigger guard.
75. On the command SQUAD – FIVE, squad members shall remove the left hand from the handguard and ensure the fire control selector is on “S”.

76. On the command SQUAD – SIX, the left hand is returned to the handguard.

77. On the command FOR INSPECTION, EXAMINE – ARMS, the five movements are combined. The standard pause shall be observed between the movements. This command may be ordered individually, by ranks or collectively at the discretion of the inspecting officer.

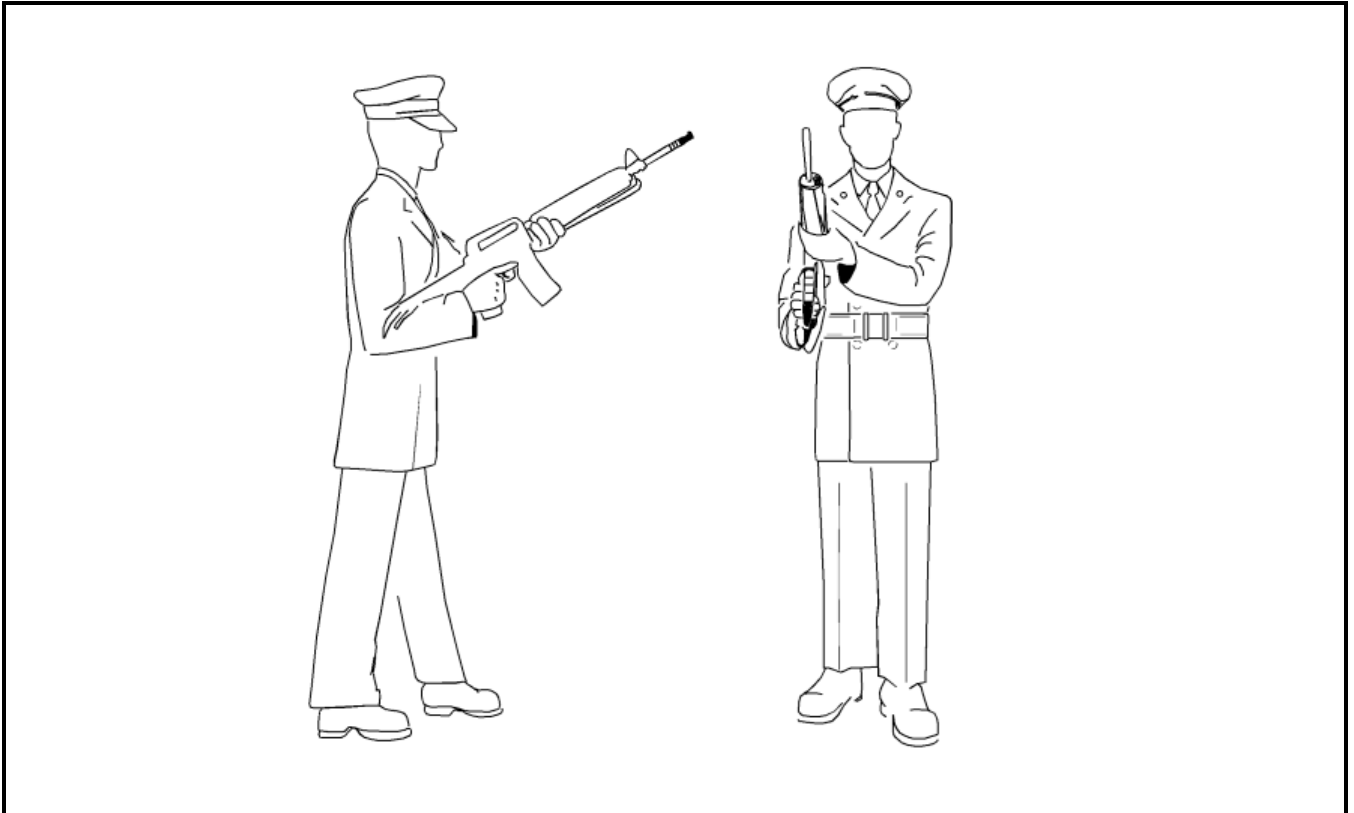
EASE SPRINGS

78. On the command EASE SPRINGS BY NUMBERS, SQUAD – ONE, squad members shall:

- a. remove the left hand from the handguard; and
- b. strike the side of the magazine with the fingers around the forward edge of the magazine and the left thumb over the bolt catch.

79. On the command SQUAD – TWO, squad members shall push the bolt in the bolt catch with the thumb of the left hand.

80. On the command SQUAD – THREE, squad members shall move the fire control selector to “R” with the thumb and forefinger of the left hand.

81. On the command SQUAD – FOUR, squad members shall return the left hand to the handguard.

82. On the command SQUAD – FIVE, squad members shall press the trigger and release it.

83. On the command SQUAD – SIX, squad members shall, with the right hand, strike the right side of the magazine housing with fingers together and extended and immediately, with the index finger, close the ejection port cover (Figure 4-1-14).

84. On the command SQUAD – SEVEN, squad members shall return the right hand to the pistol grip, the right index finger along the trigger guard.

85. On the command EASE – SPRINGS, the seven movements are combined. The standard pause shall be observed between the movements.

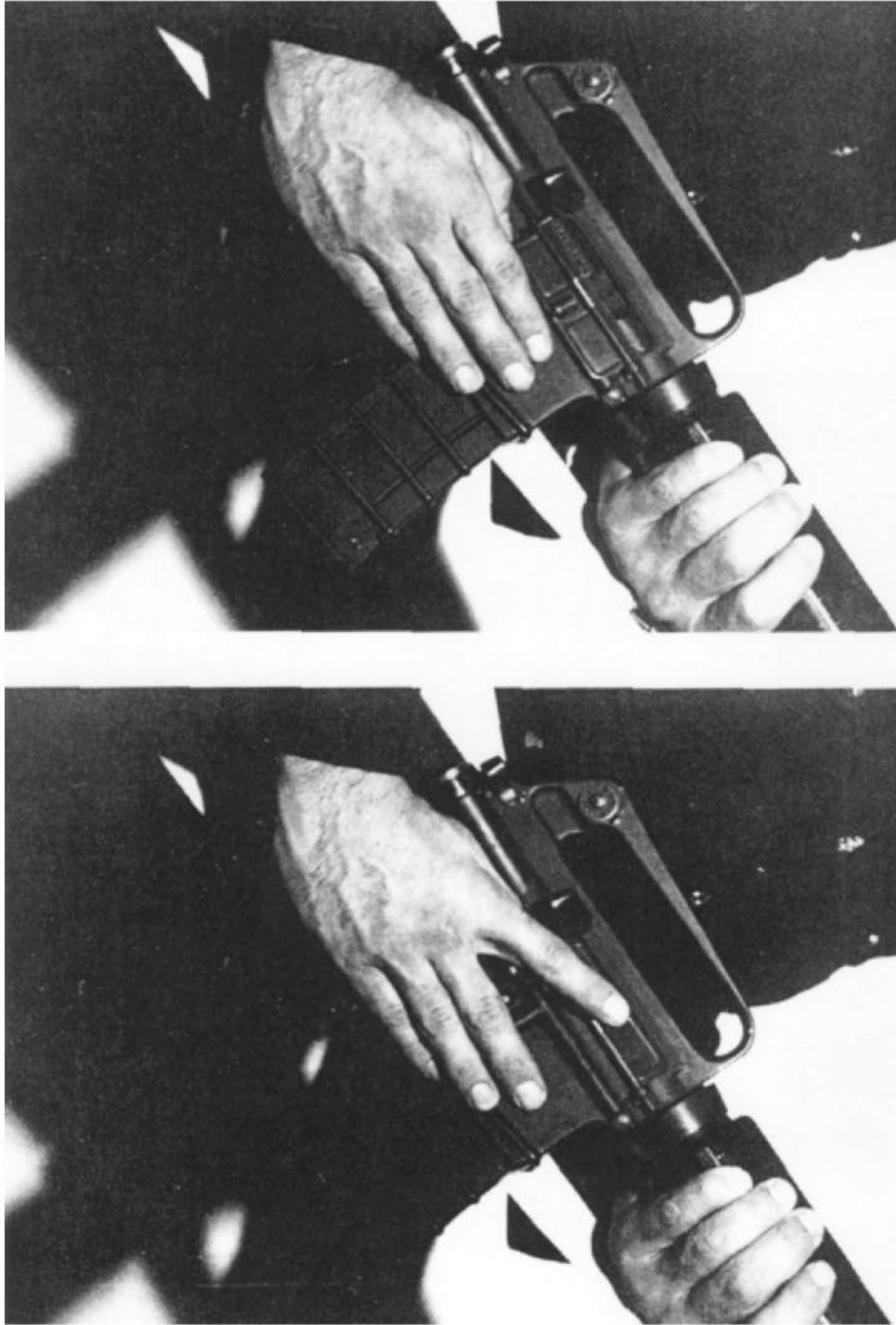

Figure 4- 1-14 Ease Springs – Six

ORDER ARMS FROM THE EXAMINE

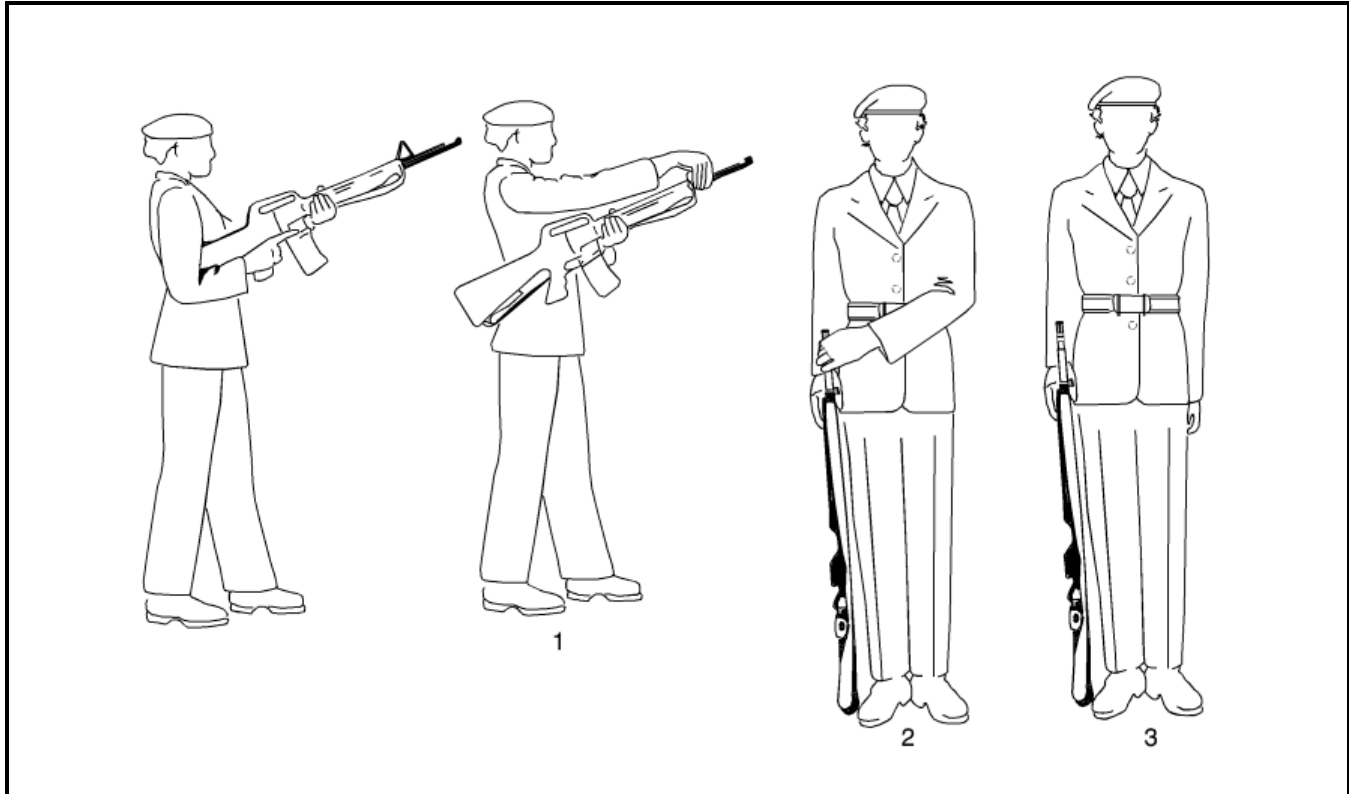

Figure 4-1-15 Order Arms from the Examine

86. On the command ORDER ARMS BY NUMBERS, SQUAD – ONE, squad members shall remove the right hand from pistol grip to strike and grasp the rifle at the front sight, ensuring that the angle of the rifle does not change (Figure 4-1-15).

87. On the command SQUAD – TWO, squad members shall:

- a. bend the left knee and assume the position of attention with the feet;
- b. with the right hand, force the rifle to the right side and assume the position of the short trail; and
- c. grasp the flash suppressor with an all-round grip of the left hand.

88. On the command SQUAD – THREE, squad members shall:

- a. cut the left hand to the side; and
- b. lower the butt to the ground and assume the position of attention.

89. On the command ORDER – ARMS, the three movements are combined. The standard pause shall be observed between the movements.

90. On other than a ceremonial parade, it is normal for each individual to ease springs, order arms and stand at ease when the inspecting officer has reached the second file to the left. The last two members of the rank act together.

SHOULDER ARMS FROM THE EXAMINE

91. This movement is executed with the carbine, but may also be used with the rifle. Similar to Chapter 5, Section 1.

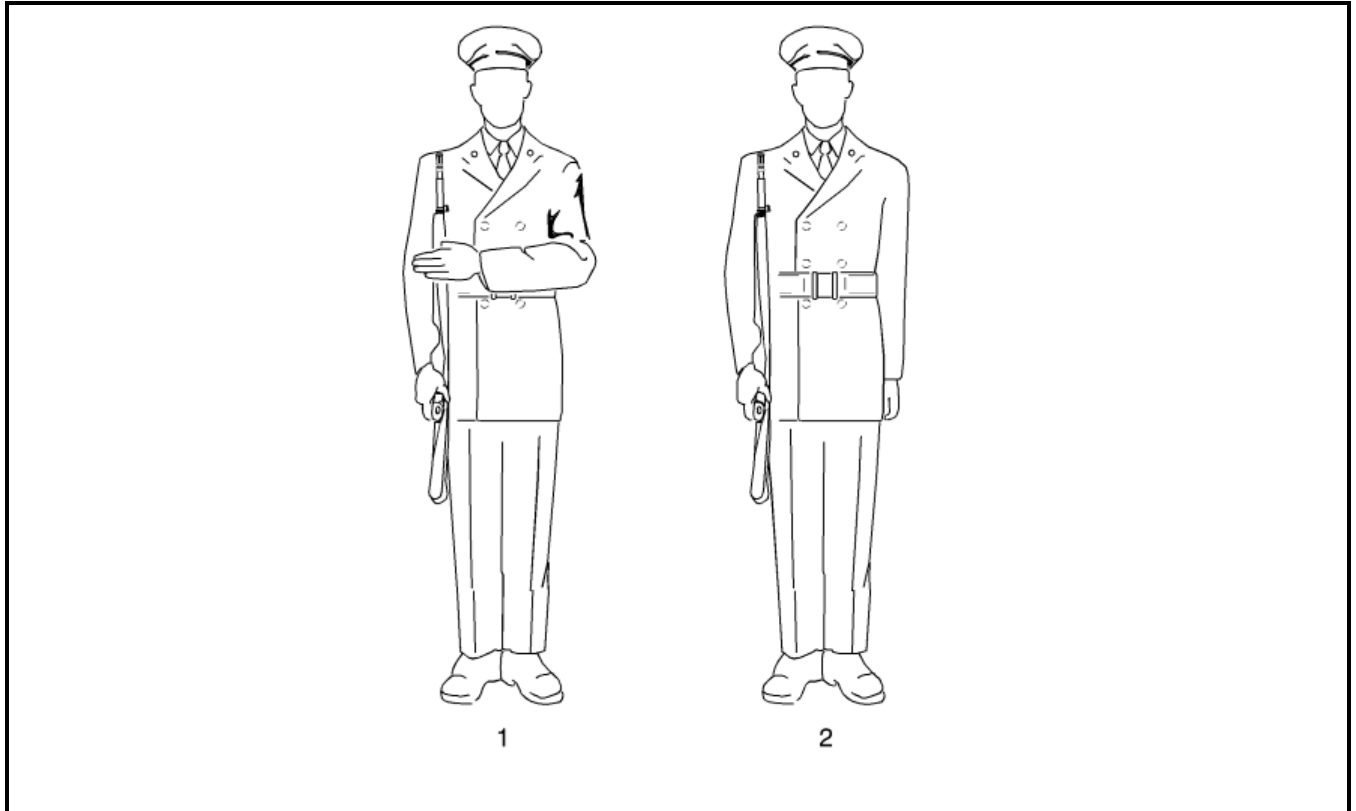
SALUTE AT THE SHOULDER**Figure 4- 1-16 Salute at the Shoulder**

92. The salute with the rifle is executed at the shoulder. The movement of the hand is the same whether saluting to the front or to a flank. The head and eyes are turned in the required direction when the salute is to a flank.

93. On the command TO THE FRONT (LEFT) (RIGHT) SALUTE BY NUMBERS, SQUAD – ONE, squad members shall:

- a. with the right hand, force the rifle forward to a vertical position and simultaneously move the left hand across the body with the forearm parallel to the ground (Figure 4-1-16); and
- b. strike the handguard with the fingers and thumb together and extended, with the back of the hand to the front and the elbow close to the body.

94. On the command SQUAD – TWO, squad members shall cut the left hand to the side and force the rifle back and assume the position of shoulder arms.

95. On the command TO THE FRONT, (LEFT) (RIGHT) – SALUTE, the two movements are combined. The standard pause is observed between the movements.

96. When an armed individual is saluting on the march, the head and eyes are turned in the required direction, and the salute shall commence and terminate as detailed in Chapter 3, paragraph 79.

PORT ARMS FROM THE ORDER

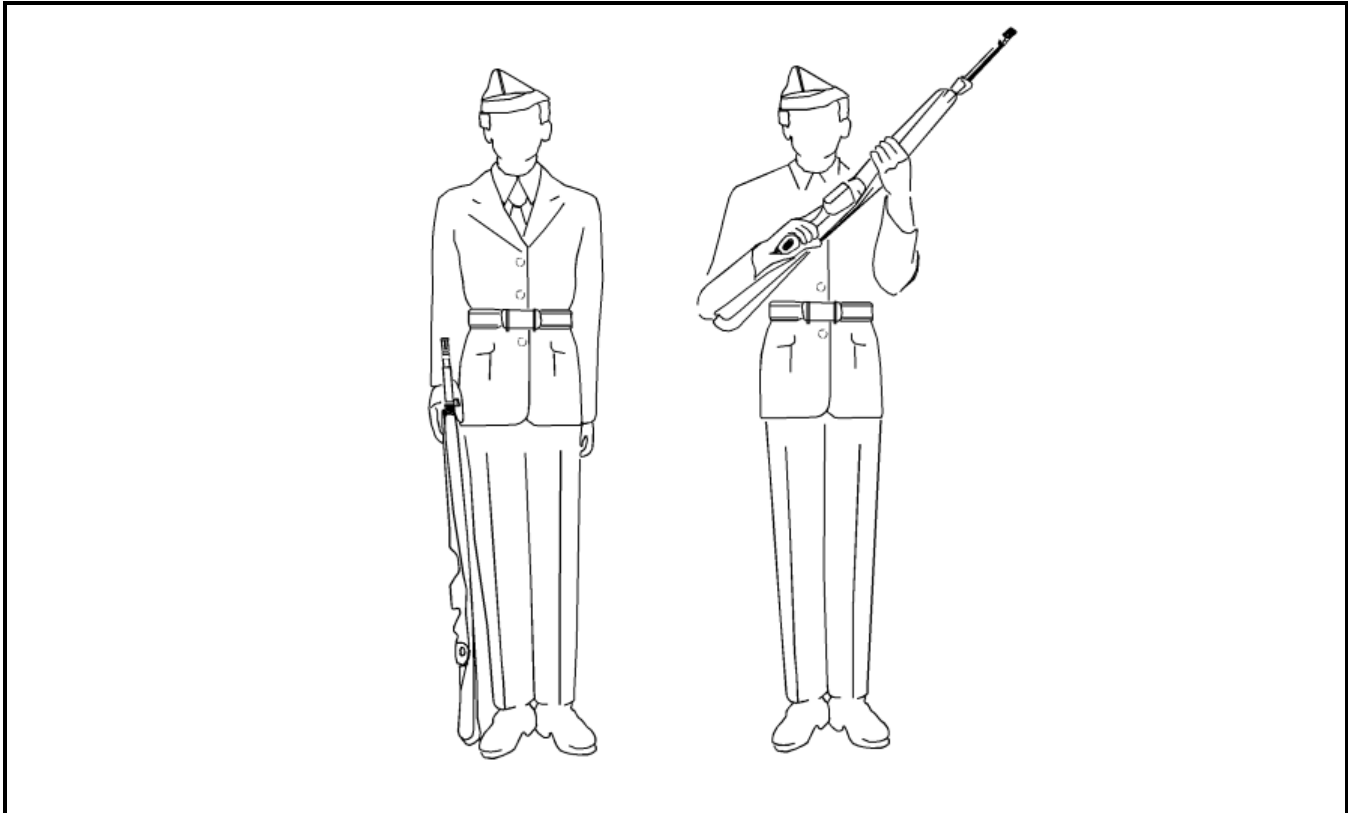
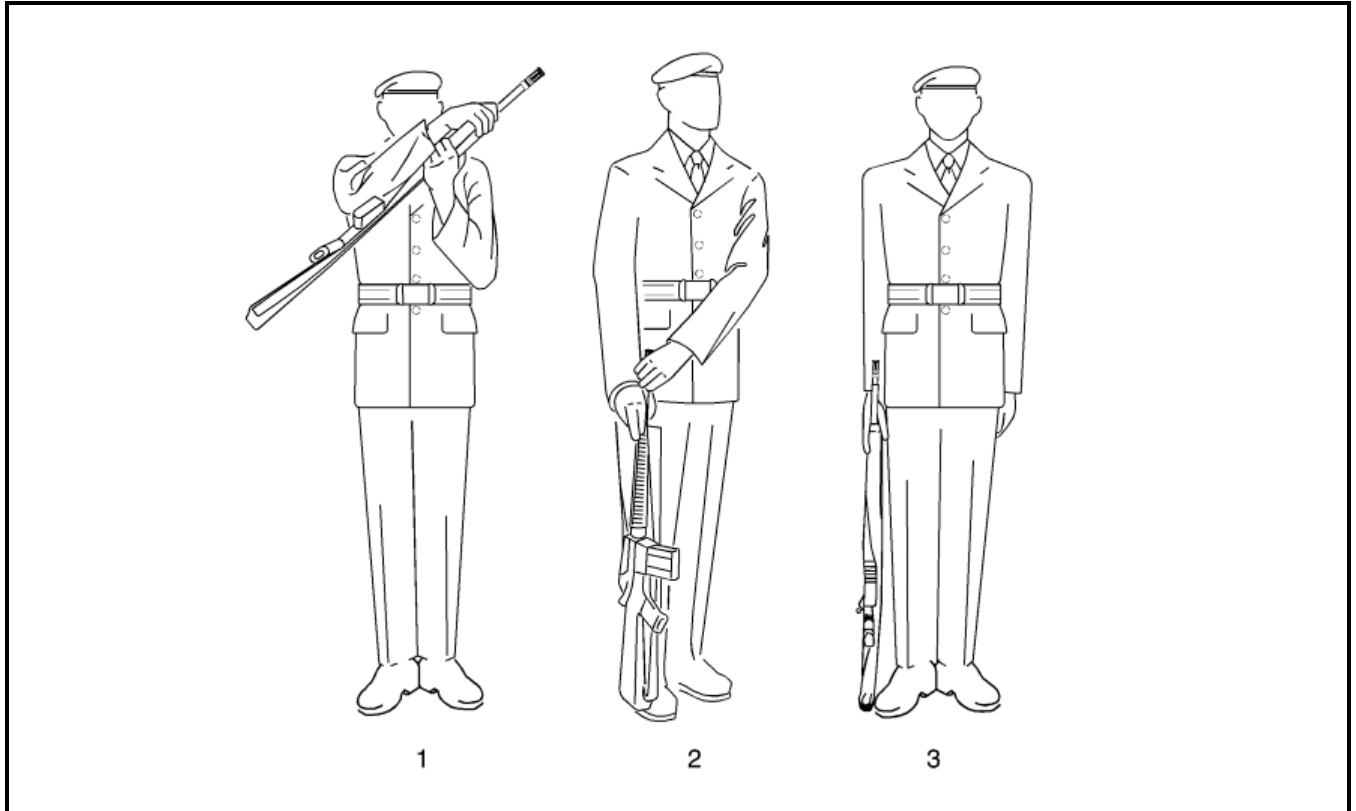

Figure 4- 1-17 Port Arms from the Order

97. On the command PORT – ARMS, squad members shall throw the weapon across the body with the muzzle leading, the magazine to the front and the barrel crossing opposite the point of the left shoulder (Figure 4-1-17). The weapon shall be caught at the handguard with the left hand, thumb and fingers around the handguard and the hand at the point of the left shoulder. As the left hand catches the weapon, the pistol grip is gripped with the right hand in an overhand grasp. Elbows shall be held close to the body and the weapon shall be held 10 cm from the body.

98. The port arms is used when doubling with the rifle.

ORDER ARMS FROM THE PORT**Figure 4- 1-18 Order Arms from the Port**

99. On the command ORDER ARMS BY NUMBERS, SQUAD – ONE, squad members shall:
- remove the right hand from the pistol grip; and
 - strike the rifle at the front sight, keeping the right forearm and elbow resting on the upper portion of the handguards (Figure 4-1-18).
100. On the command SQUAD – TWO, squad members shall:
- with the right hand, force the rifle to the right side and assume the position of the second movement of the order arms; and
 - simultaneously strike and grasp the flash suppressor with an all-round grip of the left hand.
101. On the command SQUAD – THREE, squad members shall:
- cut the left hand to the side; and
 - lower the butt to the ground and assume the position of attention.
102. On the command ORDER – ARMS, the three movements are combined. The standard pause is observed between the movements.

PORT ARMS FROM THE SHOULDER

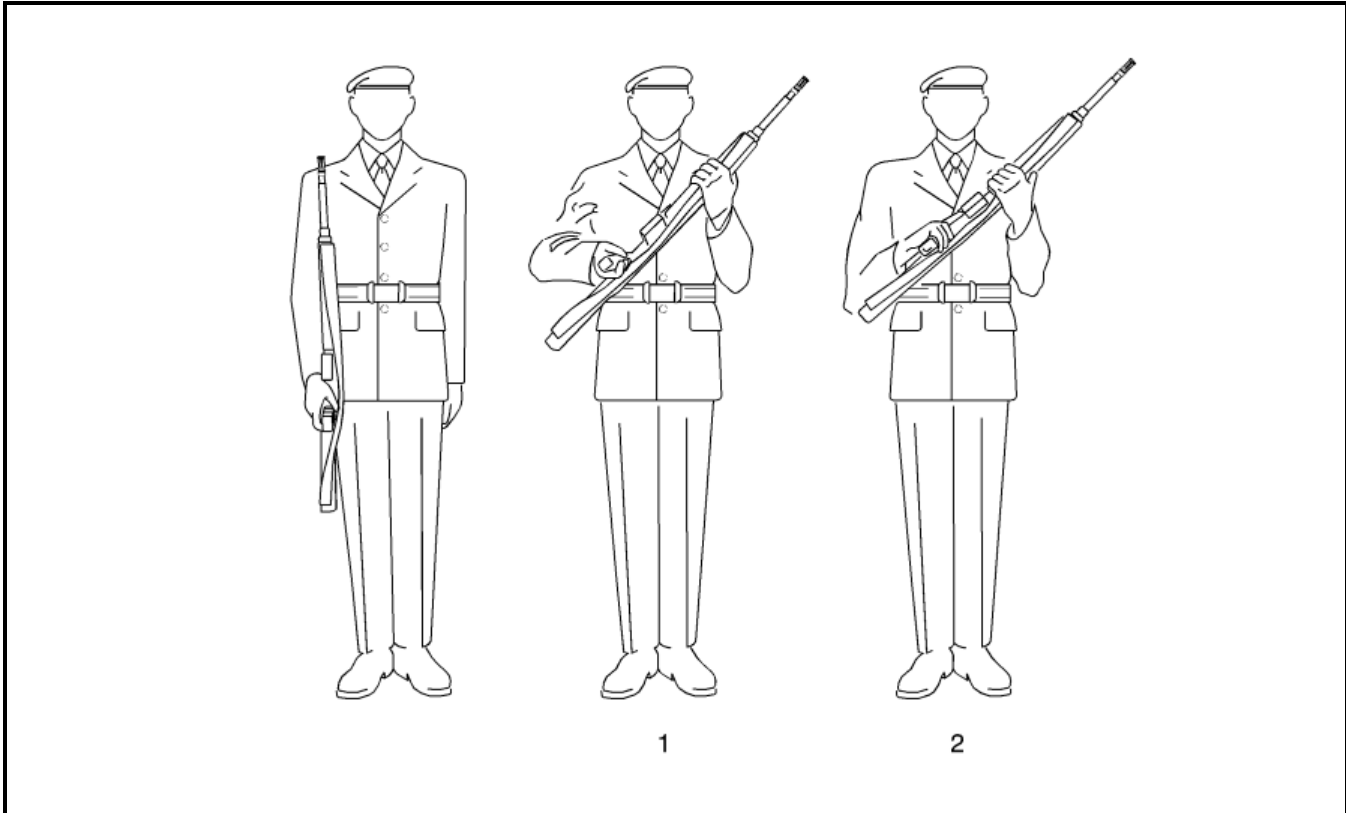

Figure 4- 1-19 Port Arms from the Shoulder

103. On the command PORT ARMS BY NUMBERS, SQUAD – ONE, squad members shall:
- with the right hand, force the rifle diagonally across the body with the muzzle upwards, the magazine to the front and the barrel crossing opposite the point of the left shoulder (Figure 4-1-19): and
 - simultaneously, strike and grasp the handguard with the left hand, with the thumb around the rifle and the hand at the point of the left shoulder.
104. On the command SQUAD – TWO, squad members shall remove the right hand from the pistol grip and strike and grip the pistol grip using an overhand grasp. The rifle shall be held 10 cm from the body.
105. On the command PORT – ARMS, the two movements are combined. The standard pause is observed between the movements.
106. This position is automatically assumed when changing from quick to double time.

SHOULDER ARMS FROM THE PORT

Figure 4- 1-20 Shoulder Arms from the Port

107. On the command **SHOULDER ARMS BY NUMBERS, SQUAD – ONE**, squad members shall:

- a. force the rifle to the shoulder arms position with the left hand (Figure 4-1-20); and
- b. simultaneously, change the position of the right hand from the pistol grip to strike and grasp the pistol grip.

108. On the command **SQUAD – TWO**, squad members shall cut the left hand to the side and assume the position of attention.

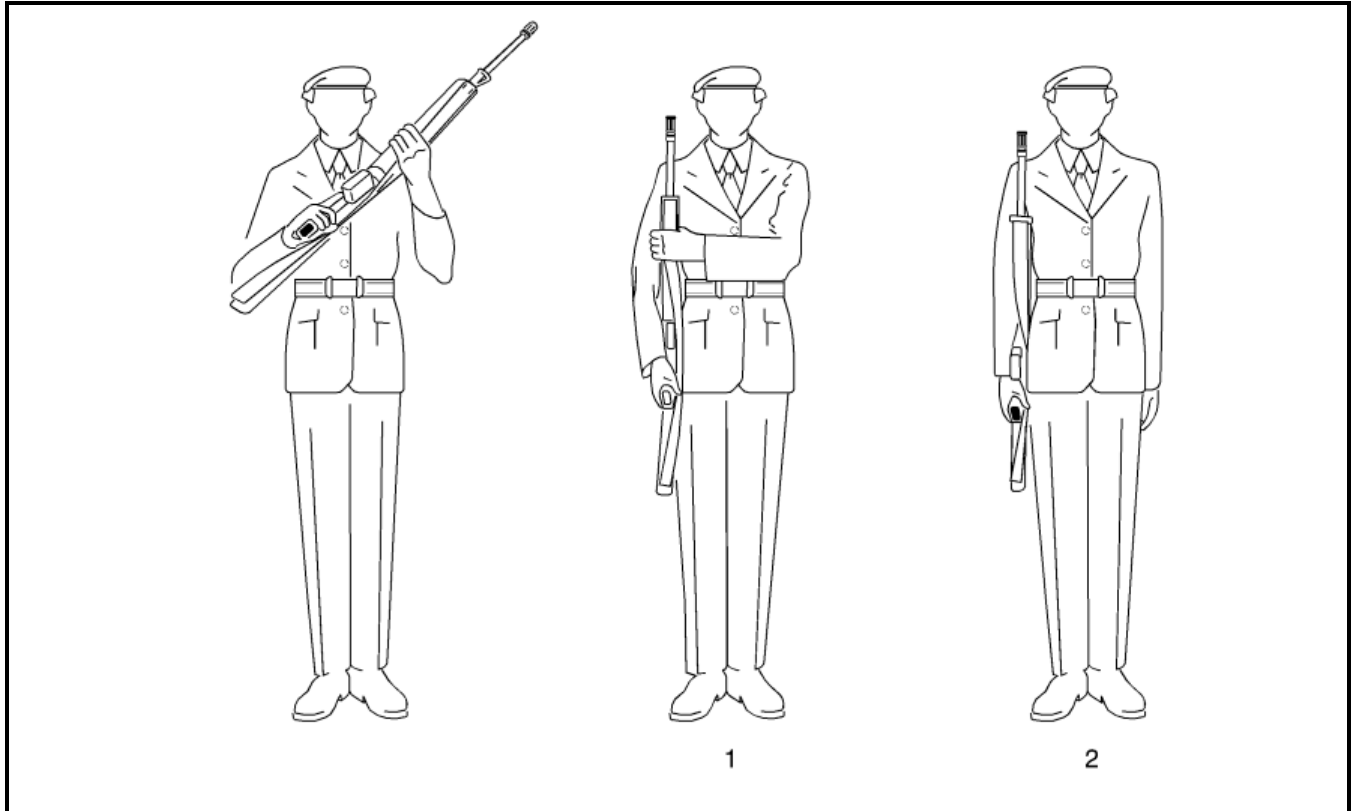
109. On the command **SHOULDER – ARMS**, the two movements are combined. The standard pause is observed between the movements.

TRAIL ARMS FROM THE SHOULDER

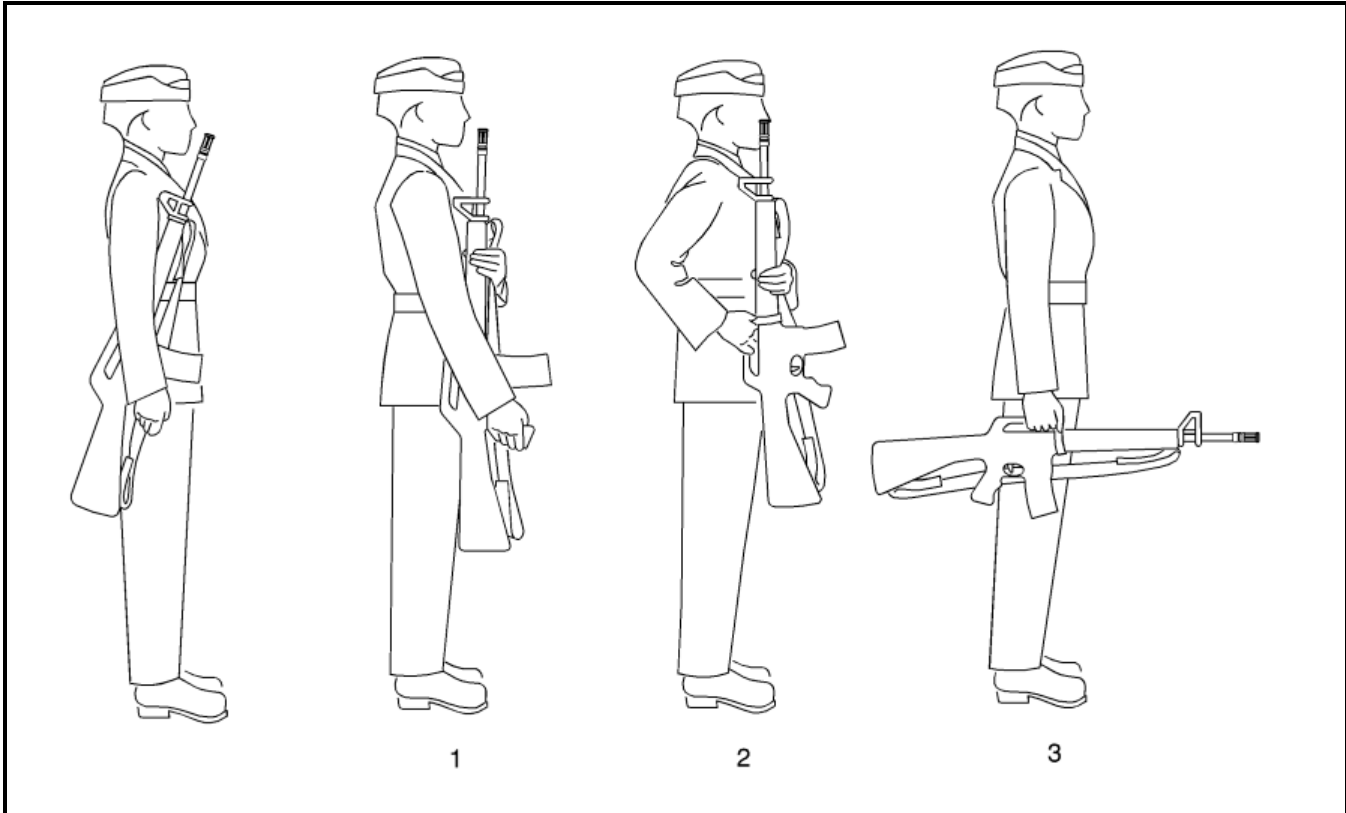

Figure 4-1-21 Trail Arms from the Shoulder

110. This movement can only be used when troops are equipped with the C7 rifle fitted with the carrying handle. The optical sight will not be used as a carrying handle. On the command TRAIL ARMS BY NUMBERS SQUAD – ONE, squad members shall:

- a. with the left forearm parallel to the ground, strike and grasp the handguard with an all-round grip of the left hand (Figure 4-1-21); and
- b. force the rifle forward to a vertical position with the right hand.

111. On the command SQUAD – TWO, squad members shall move the right hand and by the shortest route grasp the carrying handle at the upper forward portion of the handle with the thumb in front of the handle (the balance point).

112. On the command SQUAD – THREE, squad members shall:

- a. lower the rifle to a horizontal position at the full extent of the right arm with the muzzle pointing forward (the muzzle will point at a 30 degree angle inwards); and
- b. cut the left hand to the side.

113. On the command TRAIL – ARMS, the three movements are combined. The standard pause is observed between the movements.

114. The weapon is angled 30 degrees inward on the final movement to avoid barrel-butt collision with the weapon of the person in front when marching.

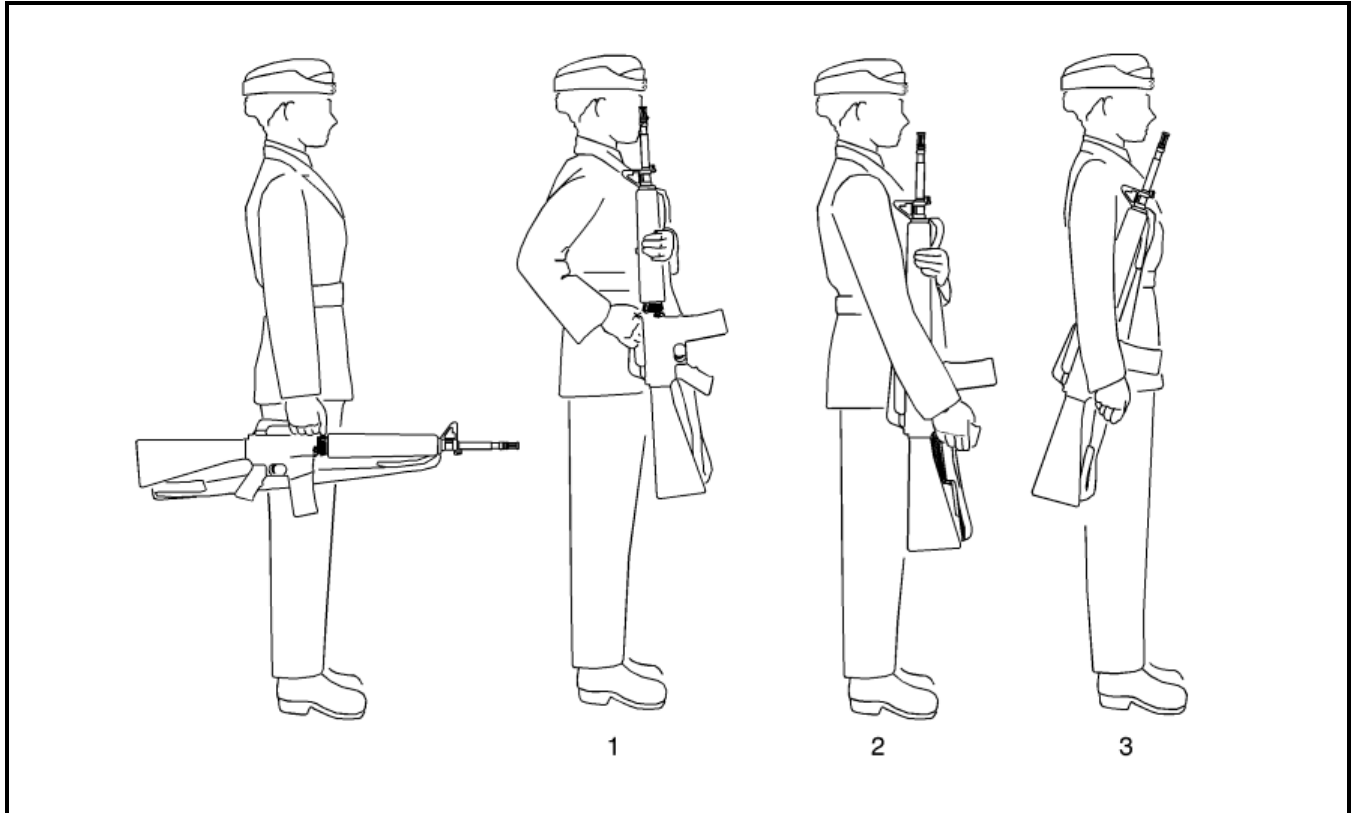
SHOULDER ARMS FROM THE TRAIL**Figure 4- 1-22 Shoulder Arms from the Trail**

115. This movement can only be used when troops are equipped with the C7 rifle fitted with the carrying handle. The optical sight will not be used as a carrying handle. On the command **SHOULDER ARMS BY NUMBERS SQUAD – ONE**, squad members shall:

- a. with the right wrist and forearm force the rifle to a vertical position with the right hand at the waist and close to the body (Figure 4-1-22); and
- b. simultaneously strike and grasp the handguard with the left hand with the left forearm parallel to the ground.

116. On the command **SQUAD – TWO**, squad members shall strike and grasp the pistol grip with the right hand.

117. On the command **SQUAD – THREE**, squad members shall cut the left arm to the side and assume the position of the shoulder arms.

118. On the command **SHOULDER – ARMS**, the three movements are combined. The standard pause is observed between the movements.

119. When turning about with the rifle at the trail, the position as detailed in paragraph 116 is adopted to prevent clashing of the rifles.

CHANGE ARMS AT THE TRAIL

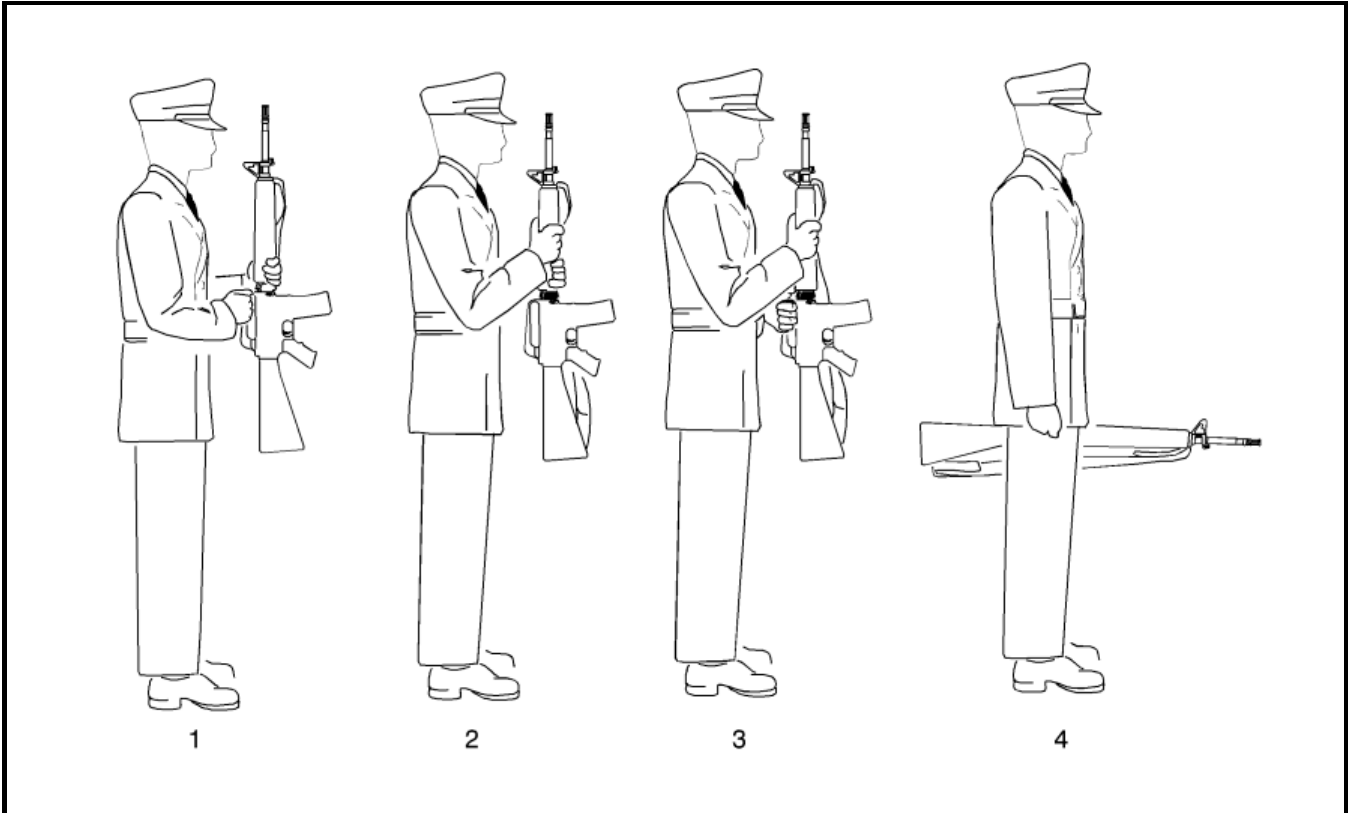

Figure 4- 1-23 Change Arms at the Trail

120. This movement can only be used when troops are equipped with the C7 rifle fitted with the carrying handle. The optical sight will not be used as a carrying handle. On the command CHANGE ARMS BY NUMBERS, SQUAD – ONE, squad members shall:

- a. bend the right arm and raise the rifle to the vertical in front of the centre of the body holding the right forearm parallel to the ground and the magazine to the front (Figure 4-1-23); and
- b. simultaneously, strike and grasp the lower end of the handguard with the left hand.

121. On the command SQUAD – TWO, squad members shall strike and grasp the handguard with the right hand immediately above the left.

122. On the command SQUAD – THREE, squad members shall grasp the carrying handle with the left hand.

123. On the command SQUAD – FOUR, squad members shall:

- a. lower the weapon to a horizontal position at the full extent of the left arm with the muzzle pointing forward (the muzzle shall point inwards at a 30 degree angle); and
- b. simultaneously, cut the right hand to the side.

124. On the command CHANGE – ARMS, the four movements are combined. The standard pause is observed between the movements.

125. To change arms from the left to the right, the movement is executed as detailed above, substituting “left” for “right” and vice versa.

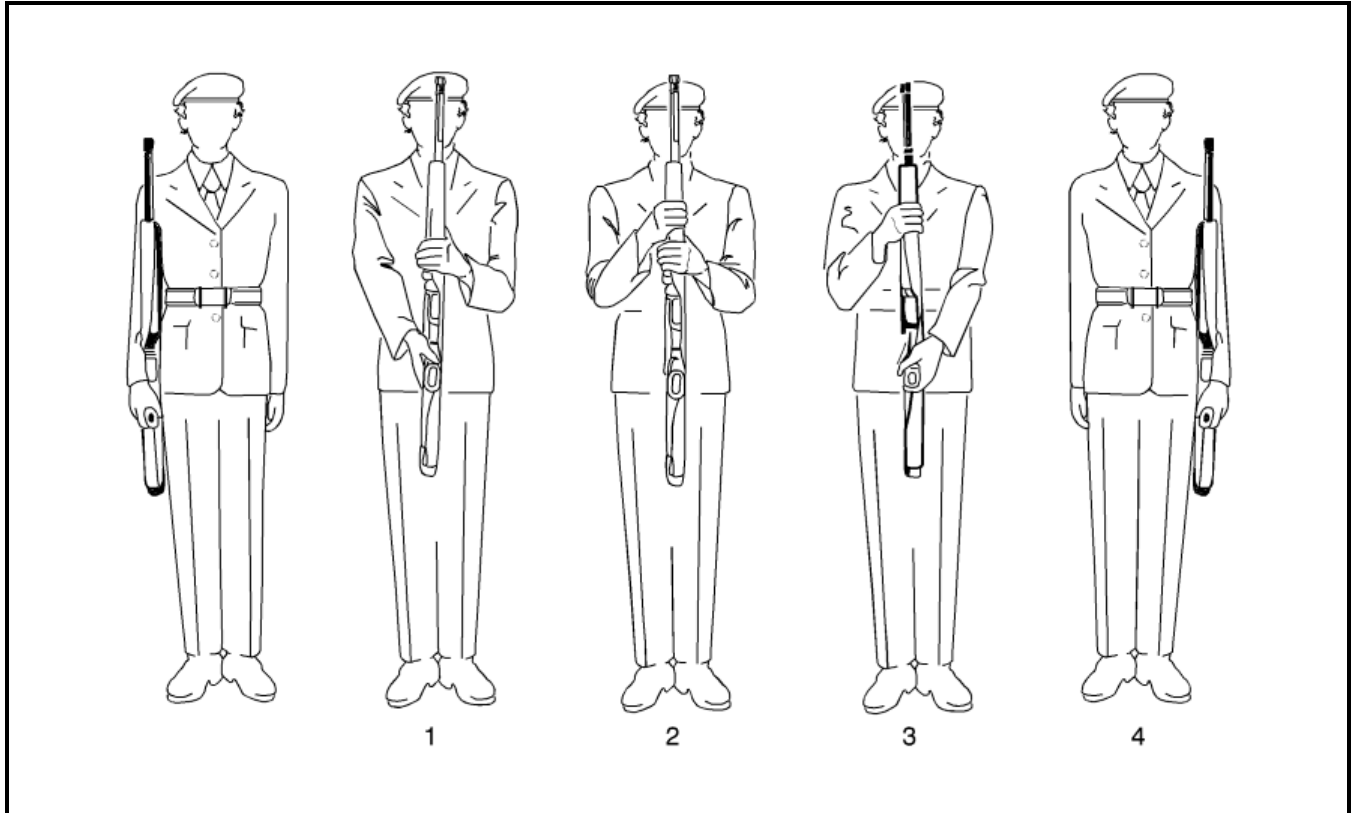
CHANGE ARMS AT THE SHOULDER**Figure 4- 1-24 Charge Arms at the Shoulder**

126. On the command CHANGE ARMS BY NUMBERS, SQUAD – ONE, squad members shall:
- with the right hand, force the rifle to a vertical position 10 cm front and centre of the body with the magazine to the front (Figure 4-1-24); and
 - strike and grasp the rifle at the handguard immediately above the magazine with an all-round grip of the left hand and the left forearm parallel to the ground.
127. On the command SQUAD – TWO, squad members shall release the pistol grip with the right hand and strike and grasp the handguard immediately above the left hand.
128. On the command SQUAD – THREE, squad members shall strike and grasp the pistol grip with the left hand.
129. On the command SQUAD – FOUR, squad members shall:
- force the rifle to the left side to the shoulder arms position; and
 - cut the right hand to the side.
130. On the command CHANGE – ARMS, the four movements are combined. The standard pause is observed between the movements.
131. To change arms from the left to the right, the movement is executed as detailed above, substituting “left” for “right” and vice versa.
132. The elbows are kept in contact with the body during all these movements.

OTHER POSITIONS FOR CARRYING THE RIFLE

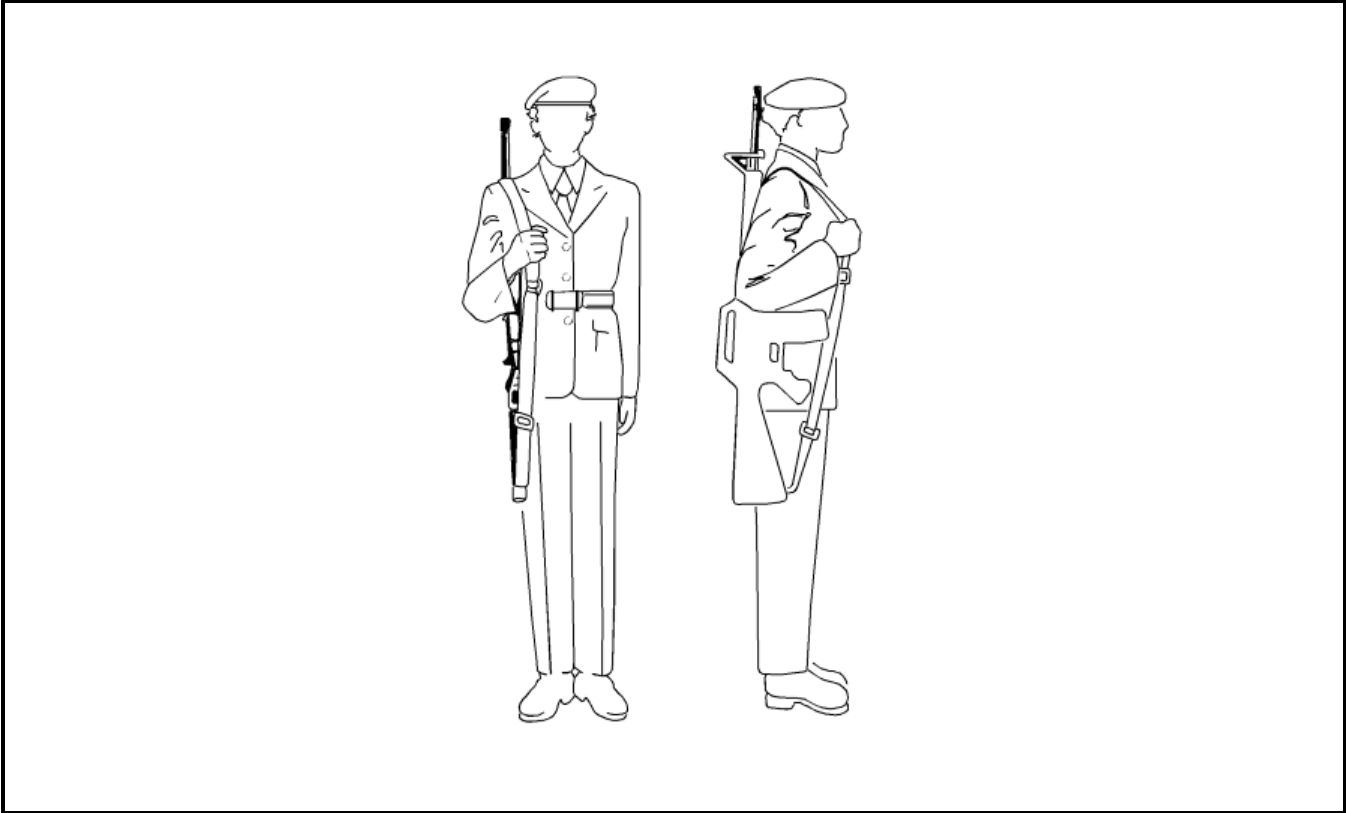

Figure 4- 1-25 Sling Arms

133. Sling Arms

- a. On the command SLING – ARMS, squad members shall loosen the sling and sling the rifle on the right shoulder with the sling in front and rifle in the rear with the muzzle pointing up (Figure 4-1-25). The right hand grasps the sling with the thumb underneath and level with the top of the breast pocket.
- b. When the rifle is slung, only the head and eyes shall be turned when saluting on the march. At the halt the position of attention is maintained. No hand salute is given.
- c. Prior to adopting other positions, the sling shall be tightened.

134. **Carrying the Rifle When Moving in Double Time.** On the command DOUBLE – MARCH, squad members shall throw the rifle to the port arms position on the first pace in double time. On the command QUICK – MARCH, the rifle is returned to the shoulder arms position commencing with the first pace in quick time. When doubling and the command HALT is ordered, the rifle is returned to the original position after a standard pause when the halt has been completed.

SECTION 2
CEREMONIAL RIFLE DRILL

RECOVER ARMS FROM THE SHOULDER

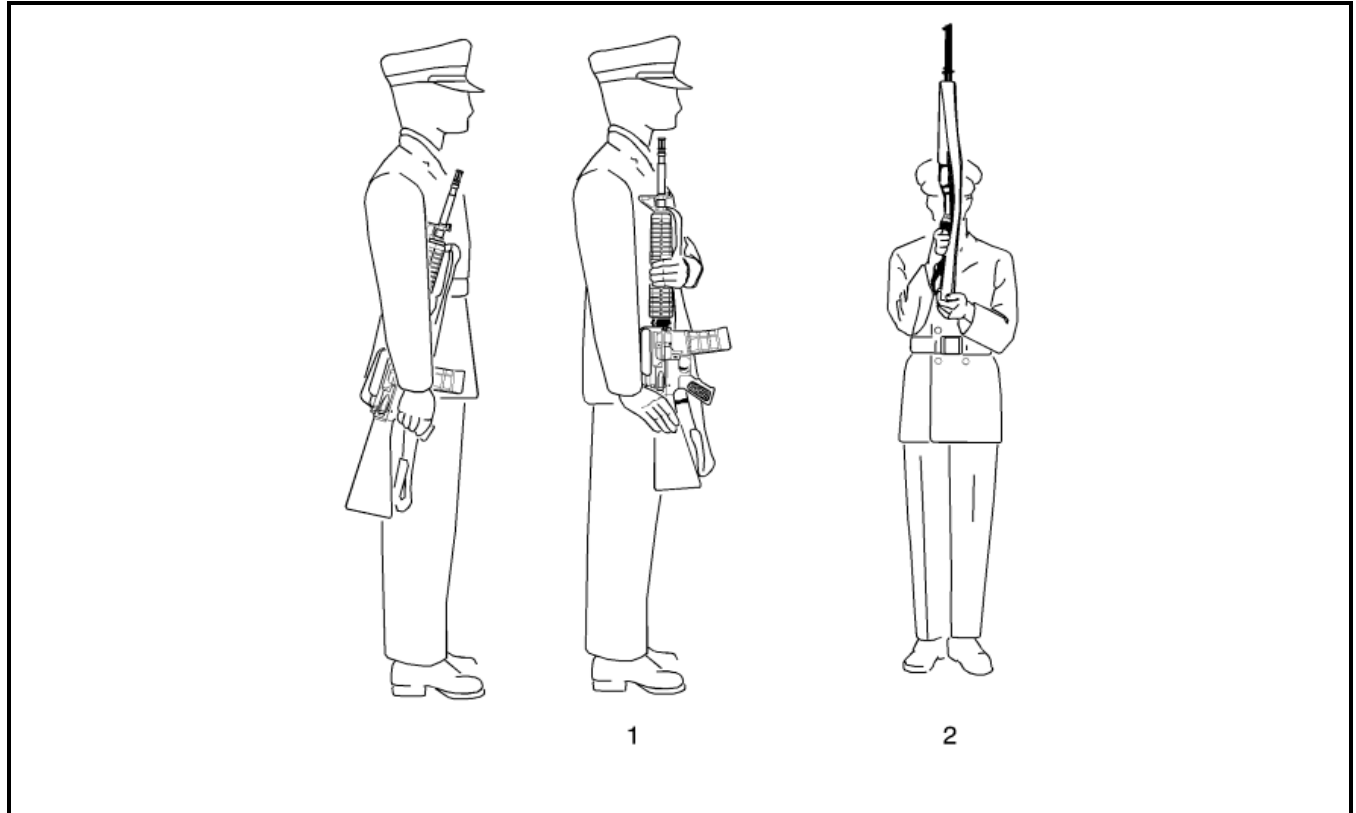

Figure 4-2- 1 Recover Arms from the Shoulder

1. On the command RECOVER ARMS BY NUMBERS, SQUAD – ONE, squad members shall:
 - a. with the right hand, flick the rifle up vertically 10 cm and strike and grasp the small of the butt with the thumb on the left and the fingers together on the right (Figure 4-2-1); and
 - b. simultaneously, with the left hand, strike and grasp the rifle at the handguard with the fingers curled around the handguard and the left forearm close to the body and parallel to the ground.
2. On the command SQUAD – TWO, squad members shall:
 - a. with the right hand, force the rifle to a vertical position in the centre of the body, the magazine to the front, the rear sight in line with and 10 cm from the mouth, the right hand assuming an all-round grasp and the back of the hand to the right; and
 - b. simultaneously, strike and grasp the butt plate with the left hand so that it is resting in the palm of the hand, thumb to the front and around the toe of the butt and fingers together and up the right side of the butt.
3. On the command RECOVER – ARMS, the two movements are combined. A standard pause shall be observed between the movements.

SHOULDER ARMS FROM THE RECOVER

4. On the command SHOULDER ARMS BY NUMBERS, SQUAD – ONE, squad members shall:
 - a. force the rifle down the right side of the body, without changing the grip of the right hand on the rifle; and
 - b. simultaneously, release the left hand from the butt plate, strike and grasp the handguard with the left hand with fingers curled around the handguard, left forearm parallel to the ground, and maintain the rifle in a vertical position.
 - c. On the command SQUAD – TWO, squad members shall lower the rifle slightly to its normal height at the shoulder arms position and strike and grasp the pistol grip with the right hand.
 - d. On the command SQUAD – THREE, squad members shall cut the left hand to the side.
 - e. On the command SHOULDER – ARMS, the three movements are combined. A standard pause shall be observed between the movements.

REST ON YOUR ARMS REVERSED FROM THE PRESENT

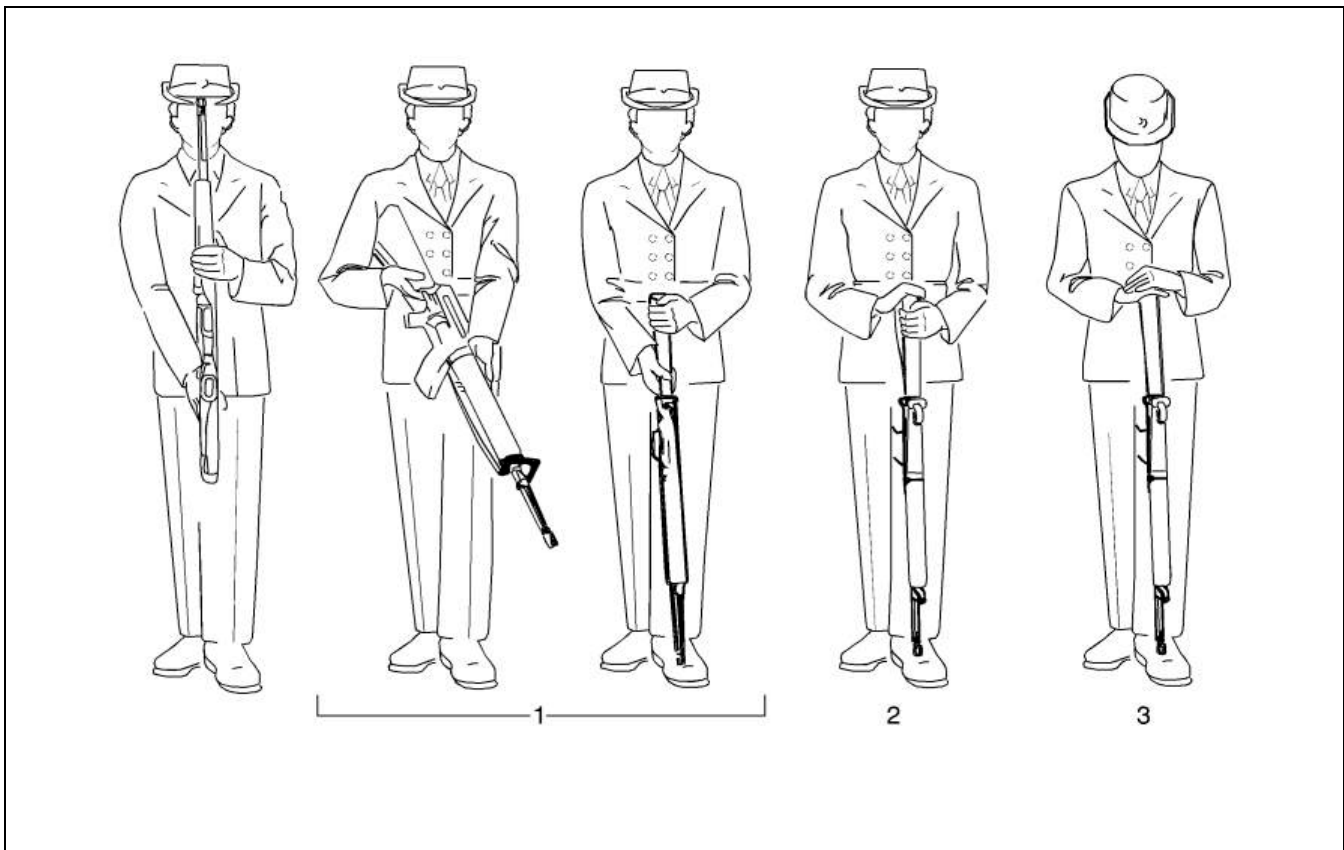

Figure 4-2- 2 Rest on our Arms Reversed from the Present

5. On the command REST ON YOUR ARMS REVERSED BY NUMBERS, SQUAD – ONE, squad members shall force the weapon forward to the full extent of the arms and simultaneously rotate the butt under the right arm pit, lower the barrel forward and downward onto the left boot, grasping the butt below the heel with the left hand. The muzzle shall be placed on the toe crease of the left boot with the rifle vertical and the magazine resting against the inner portion of the left leg (Figure 4-2-2). The entire movement is executed to a count of ten seconds.
6. On the command SQUAD – TWO, squad members shall place the right hand on the butt plate with the thumb around the toe of the band and the fingers together.

7. On the command SQUAD – THREE, squad members shall place the left hand over the right, drop the elbows to the sides and lower the head until the chin touches the chest.

8. On the command REST ON YOUR ARMS – REVERSED, the three movements are combined. All movements shall be executed without pause and with smooth and solemn dignity. A count of 10 seconds shall be used to complete the entire sequence as follows:

- a. 8 seconds, SQUAD-ONE completed,
- b. 9 seconds, SQUAD-TWO completed, and
- c. 10 seconds, SQUAD-THREE completed.

PRESENT ARMS FROM REST ON YOUR ARMS REVERSED

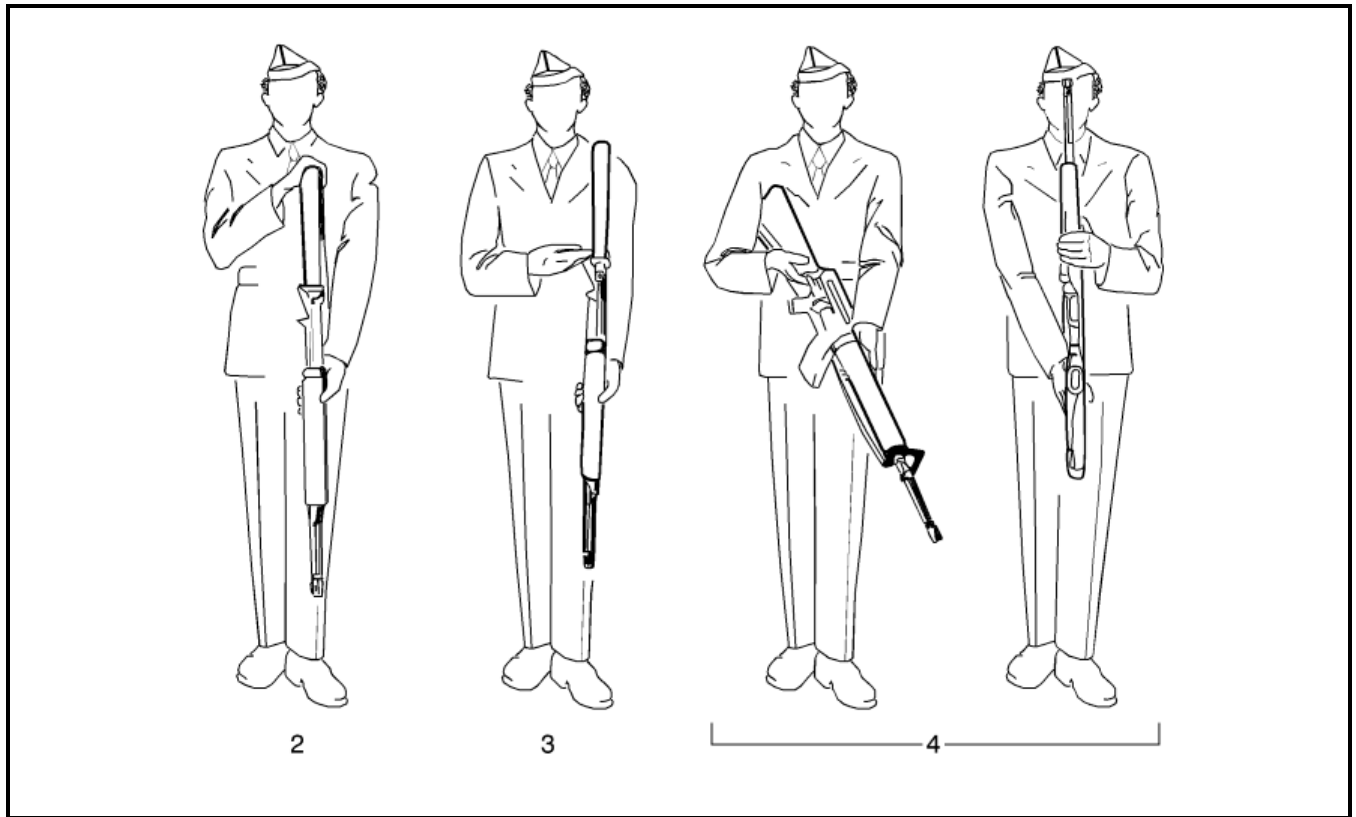

Figure 4-2-3 Present Arms from the Rest on your Arms Reversed

9. On the command PRESENT ARMS BY NUMBERS, SQUAD – ONE, squad members shall raise the head and eyes and look to the front.

10. On the command SQUAD – TWO, squad members shall lift the weapon 10 cm outwards from the body with the right hand until the left hand grasps the handguard, the back of the left hand to the rear with the thumb pointing down the handguard and the left arm kept straight (Figure 4-2-3).

11. On the command SQUAD – THREE, squad members shall place the right hand between the weapon and sling with the palm up and the first knuckle of the index finger at the small of the butt.

12. On the command SQUAD – FOUR, squad members shall move the butt between the body and the right arm and rotate the weapon to the present arms position.

13. On the command PRESENT – ARMS, the four movements are combined. A standard pause shall be observed between each movement.

FIRING CARTRIDGES FROM THE ORDER

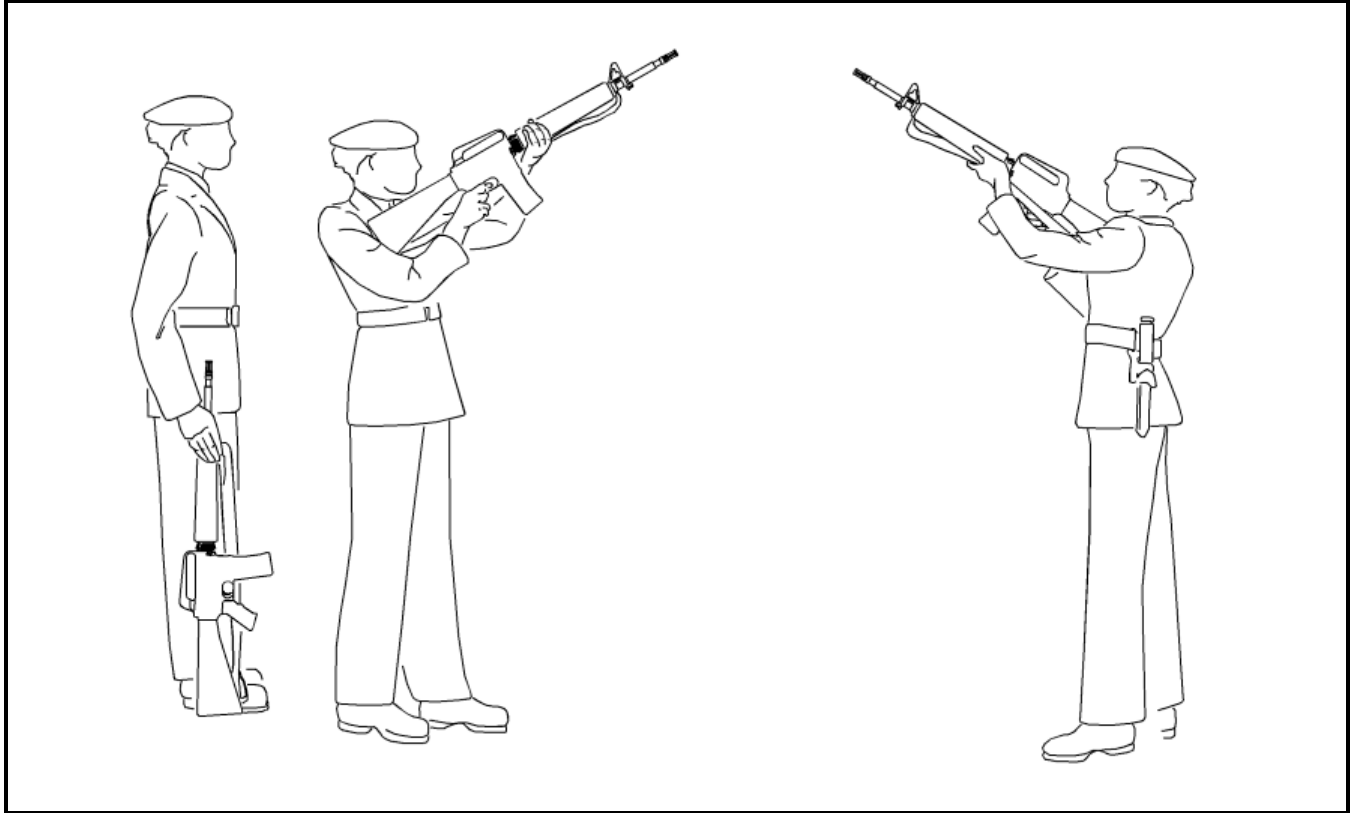

Figure 4-2- 4 Firing Cartridges from the Order

14. In the falling-in area, the necessary number of blank rounds are loaded in the magazine and, with the working parts forward and the fire control selector at "S", the magazine is placed on the rifle.
15. With the rifle held in the order position, on the command **WITH BLANK CARTRIDGES, STANDING LOAD BY NUMBERS, SQUAD – ONE**, squad members shall:
 - a. take a half pace forward with the left foot (Figure 4-2-4);
 - b. simultaneously, with the right hand, throw the rifle up and forward to an angle of 45 degrees, grasp the handguard with the left hand immediately in front of the magazine, and hold the sling in the palm of the left hand; and
 - c. with the right hand, grasp the pistol grip, the right forefinger outside the trigger guard, and the butt forced into the side between the right forearm and the body.
16. On the command **SQUAD – TWO**, squad members shall:
 - a. remove the hand from the pistol grip; and
 - b. grasp the cocking handle with the index and middle finger.
17. On the command **SQUAD – THREE**, with the right hand, pull the cocking handle to the rear and release it.
18. On the command **SQUAD – FOUR**, return the right hand to the pistol grip.

19. On the command SQUAD – FIVE, squad members shall move the fire control selector to “R” with the thumb and forefinger of the left hand (see paragraph 40).
20. On the command SQUAD – SIX, squad members shall return the left hand to the handguard.
21. On the command WITH BLANK CARTRIDGES, STANDING – LOAD, the six movements are combined. A standard pause is observed between the movements.
22. On the command PRESENT, squad members shall bring the rifle to the right shoulder at an angle of 45 degrees and place the right forefinger inside the trigger guard.
23. On the command FIRE, squad members shall press the trigger and release it.
24. On the command RELOAD BY NUMBERS, SQUAD – ONE, squad members shall return the rifle to the position of squad one, with blank cartridges, standing – load.
25. On the command SQUAD – TWO, squad members shall grasp the cocking handle with the index and middle fingers of the right hand.
26. On the command SQUAD – THREE, squad members shall pull the cocking handle to the rear and release it.
27. On the command SQUAD – FOUR, squad members shall return the right hand to the pistol grip.
28. On the command RELOAD, the four movements are combined. A standard pause is observed between the movements.
29. On the command MAKE SAFE BY NUMBERS, SQUAD – ONE, squad members shall return the rifle to the position of squad one, with blank cartridges, standing-load.
30. On the command SQUAD – TWO, squad members shall move the fire control selector to “S” with the thumb and forefinger of the left hand.
31. On the command SQUAD – THREE, squad members shall return the left hand to the handguard.
32. On the command SQUAD – FOUR, squad members shall, with the right hand, strike the right side of the magazine housing with fingers together and extended and immediately, with the index finger, close the ejection port cover.
33. On the command SQUAD – FIVE, squad members shall return the right hand to the pistol grip, the right forefinger outside the trigger guard.
34. On the command MAKE – SAFE, the five movements are combined. A standard pause is observed between the movements.
35. On the command ORDER – ARMS, the squad shall act as for ordering arms from the examine arms position.
36. When making safe, it is essential to move the fire control selector to “S” in case not all of the rounds have been fired.
37. The squad, on completion of the firing party drill, will be marched to a safe area where the unload drill will be ordered.

FIRING VOLLEYS – MILITARY FUNERALS

38. A firing party is authorized to fire volleys at a military funeral if specifically requested by the next-of-kin. The firing party shall be formed from the funeral guard commanded by the funeral guard commander and will comprise:

- a. for a colonel and below, the funeral guard as detailed in A-AD-200-000/AG-000, The Honours, Flags and Heritage Structure of the CF (soon to become A-DH-200-000/AG-000; The Heritage Structure of the CAF), Chapter 13; and
- b. for a brigadier-general and above, the funeral guard commander and the first 12 corporals/privates of the front rank of the funeral guard.

39. If a brigadier-general or above is to be accorded military honours by gun salute as detailed in A-AD-200-000/AG-000, The Honours, Flags and Heritage Structure of the CF (soon to become A-DH-200-000/AG-000; The Heritage Structure of the CAF), Chapter 13, volleys shall not be fired in addition to the salute of guns.

40. For rifle volleys, three blank rounds shall be fired.

41. On the completion of the service and after the parade commander has ordered PARADE REPLACE – HEADDRESS, the funeral guard/firing party commander shall give the following commands:

- a. GUARD/FIRING PARTY PRESENT – ARMS;
- b. FIRING PARTY :
 - (1) SHOULDER – ARMS,
 - (2) ORDER – ARMS,
 - (3) WITH BLANK CARTRIDGES STAN-DING – LOAD,
 - (4) PRESENT,
 - (5) FIRE,
 - (6) RELOAD,

NOTE

A five seconds pause shall be observed between volleys, otherwise orders at sub-subparagraphs (4), (5) and (6) are repeated until three blank rounds have been fired.

- (7) MAKE – SAFE, and
- (8) ORDER – ARMS;
- c. FIRING PARTY SHOULDER – ARMS, PRESENT – ARMS; and
- d. GUARD SHOULDER – ARMS, ORDER – ARMS.

42. If the guard is for a colonel or below; the orders at subparagraphs c. and d. are omitted since the guard and firing party are the same and the latter has no larger group to rejoin.

43. After the volleys have been fired, the funeral service will continue as noted in Chapter 11.

NOTE

In accordance with B-GL-381-001/TS-000, Operational Training-Training Safety, Chapter 4, Section 2, paragraph 403: Safety distance for firing blank cartridges for ceremonial reasons is twenty (20) meters.

REVERSE AR4MS FROM THE SHOULDER

Figure 4-2- 5 Reverse Arms from the Shoulder

44. Reversed arms may be used as a sign of mourning in a funeral procession by marching troops who are armed with swords/rifles/carbines.
45. Weapons should be reversed before stepping off.
46. When changing to quick time on the processional route, the rear hand shall be removed from the weapon and the arm swung. The sword hilt or rifle/carbine butt shall be dropped to bring the weapon to a horizontal position under the armpit. In the final movement, the rifle/carbine shall be pushed up from the rear by the disengaged arm which is then cut and swung.
47. When for any reason the procession is halted unexpectedly, weapons shall be carried in the reverse arms position, except that if a long delay is anticipated, weapons shall be ordered to the shoulder arms (carry position for swords) position. Weapons should again be reversed before stepping off.
48. Pistols shall remain in holsters.
49. On the command REVERSE ARMS BY NUMBERS, SQUAD – ONE, squad members shall:
 - a. with the right hand, flick the weapon up vertically 10 cm and then strike and grasp the small of the butt with the thumb on the left and the fingers together on the right; and

- b. simultaneously, with the left hand, strike and grasp the weapon at the handguard with the fingers curled around the handguard, and the left forearm close to the body and parallel to the ground.

NOTE

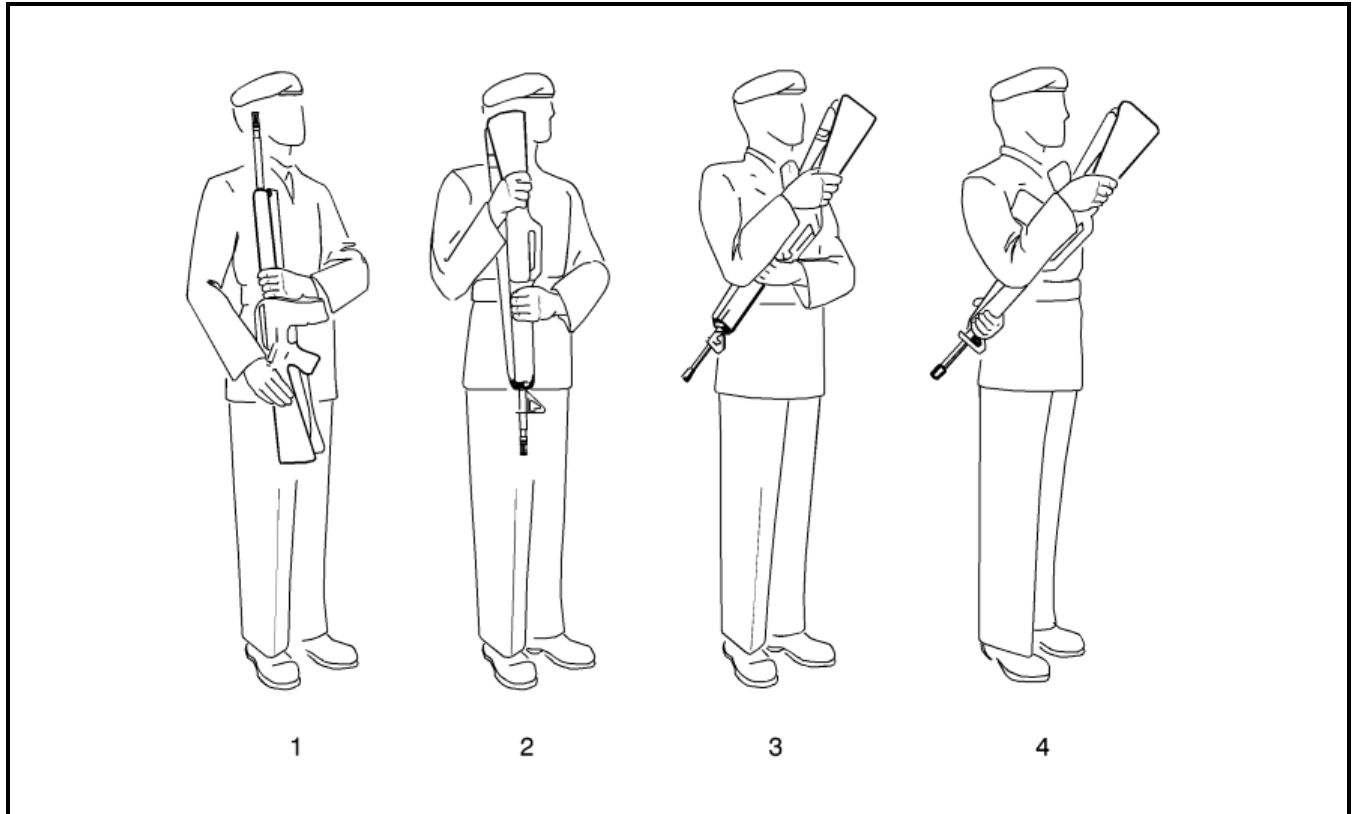
This movement is the same as the first movement for the recover arms and the present arms (Figure 4-2-5).

50. On the command SQUAD – TWO, squad members shall:
 - a. force the barrel forward and downwards, with the left hand changing the grip of the left hand on the handguard so that the back of the hand is to the front and the thumb is curled round the back (the left arm will be held in close to the body); and
 - b. simultaneously, bring the butt up between the elbow and the body, changing the grip of the right hand on the small of the butt, fingers and thumb curled around the small of the butt, fingers around the front and thumb to the side so that the right hand is in line with the right shoulder, back of the hand to the right, the weapon now being in a vertical position, barrel down.
51. On the command SQUAD – THREE, squad members shall force the rifle under the right armpit with the left hand, magazine just in front of the right shoulder, toe of the butt in line with the right eye. The weapon will be at an angle of 45 degrees.
52. On the command SQUAD – FOUR, squad members shall quit the handguard with the left hand and transfer the left hand behind the back, grasping the handguard behind the front sight, the back of the hand towards the ground.
53. On the command REVERSE – ARMS, the four movements are combined. The standard pause shall be observed between the movements.

SHOULDER ARMS FROM THE REVERSE

54. On the command SHOULDER ARMS – ONE, squad members shall:
 - a. allow the barrel to swing forward until the weapon is vertical; and
 - b. simultaneously, change the position of the left hand so as to grasp the handguard, back of the hand to the rear, thumb to the left and fingers to the right.
55. On the command SQUAD – TWO, squad members shall return the weapon to the shoulder arms position by forcing the butt down between the elbow and the body and rotating the weapon between the fingers until the barrel is pointing upwards.
56. On the command SQUAD – THREE, strike and grasp the pistol grip with the right hand.
57. On the command SQUAD – FOUR, squad members shall cut the left hand to the side and simultaneously force the rifle back until the thumb of the right hand is in line with the trouser seam.
58. On the command SHOULDER – ARMS, the four movements are combined. The standard pause shall be observed between the movements.

CHANGE ARMS AT THE REVERSE

59. On the command CHANGE ARMS BY NUMBERS, SQUAD – ONE, squad members shall:
 - a. release the weapon with the left hand and return the left arm to the side; and

- b. simultaneously, holding the weapon at the small of the butt with the right hand, allow the barrel to swing forward so that the weapon is vertical. Keep the right hand level with the top of the breast pocket.
60. On the command SQUAD – TWO, squad members shall transfer the weapon across the body and grasp it at the small of the butt with the left hand level with the top of the breast pocket.
61. On the command SQUAD – THREE, squad members shall cut the right hand to the side.
62. On the command SQUAD – FOUR, squad members shall:
- a. force the weapon under the left armpit with the left hand; and
 - b. simultaneously, shoot the right hand across the body, forcing the handguard under the armpit.
63. On the command SQUAD – FIVE, squad members shall force the right arm around and behind the body, the right hand grasping the handguard behind the front sight, the back of the hand toward the ground.
64. On the command CHANGE – ARMS, the five movements are combined. The standard pause shall be observed between the movements.
65. To change back to the right side, the process is reversed.

CHAPTER 5**C8 CARBINE DRILL****SECTION 1****BASIC CARBINE DRILL****INTRODUCTION**

1. Carbine drill is a variation of rifle drill. The only differences are described in this chapter. If no detail is given, the drill is the same as for rifles; see Chapter 4.
2. Where “small of the butt” is mentioned in Chapter 4, substitute “small of the sliding buttstock” in this chapter (Figure 5-1-1).
3. When the carbine is used on drill and ceremonial parades, the sling shall be kept taut on the lefthand side of the magazine. The sliding buttstock shall be extended.
4. On parades where carbines and rifles are carried, personnel carrying carbines shall remain at the shoulder arms position whenever the command order arms is given.

SHOULDER ARMS (POSITION OF ATTENTION)

Figure 5-1- 1 Shoulder Arms (Position of Attention)

5. The position of shoulder arms is the position of attention when carrying the carbine (Figure 5-1-2).

STAND AT EASE FROM ATTENTION

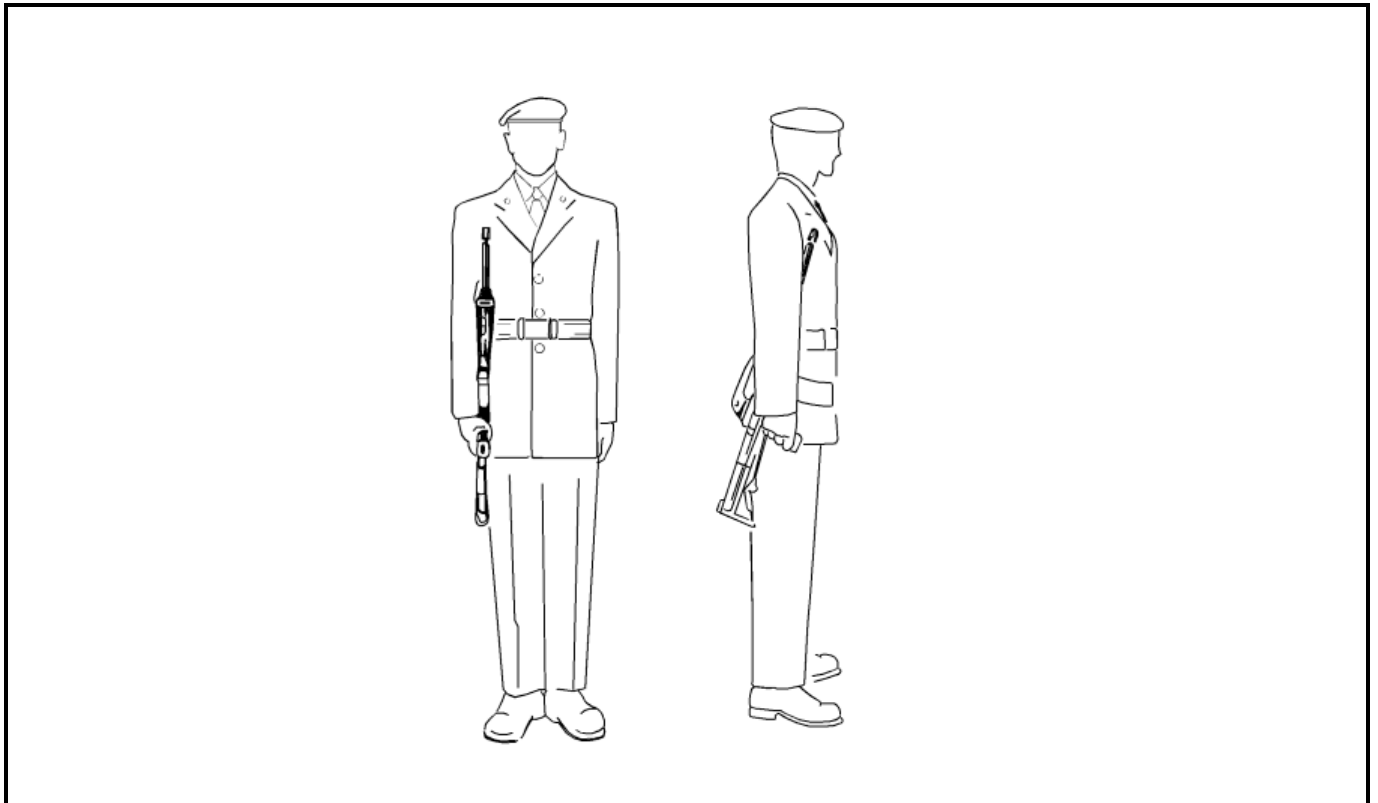
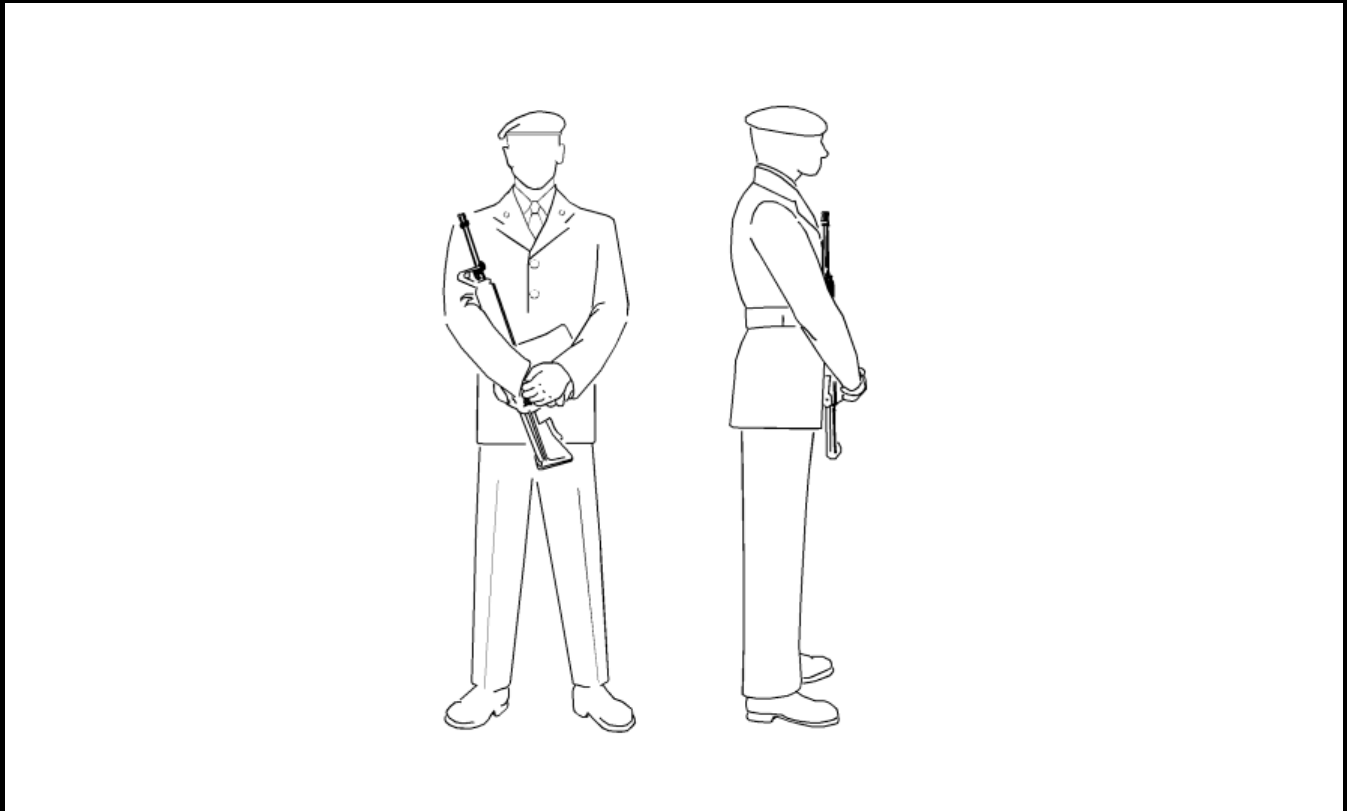

Figure 5-1- 2 Position of Stand at Ease

6. On the command STAND AT – EASE, squad members shall:
 - a. with the right hand, bring the carbine to a diagonal position in front of the body with the butt toward the left knee, the muzzle towards the right shoulder and the magazine to the left (Figure 5-1-3);
 - b. place the left hand over the right so the back of the right hand is in the palm of the left; and
 - c. simultaneously, bend the left knee and place the left foot on the ground 25 cm to the left.

STAND EASY FROM THE STAND AT EASE

7. On the command STAND – EASY, the body is relaxed in the stand at ease position and no other movement takes place.

STAND AT EASE FROM THE STAND EASY

8. On the command SQUAD, the position of stand at ease is assumed.

ATTENTION FROM STAND AT EASE

9. On the command ATTEN – TION, squad members shall:
 - a. bend the left knee and bring the left foot at the position of attention; and
 - b. simultaneously, force the carbine to the right side and cut the left hand to the side and assume the position of attention.

C8 CARBINE

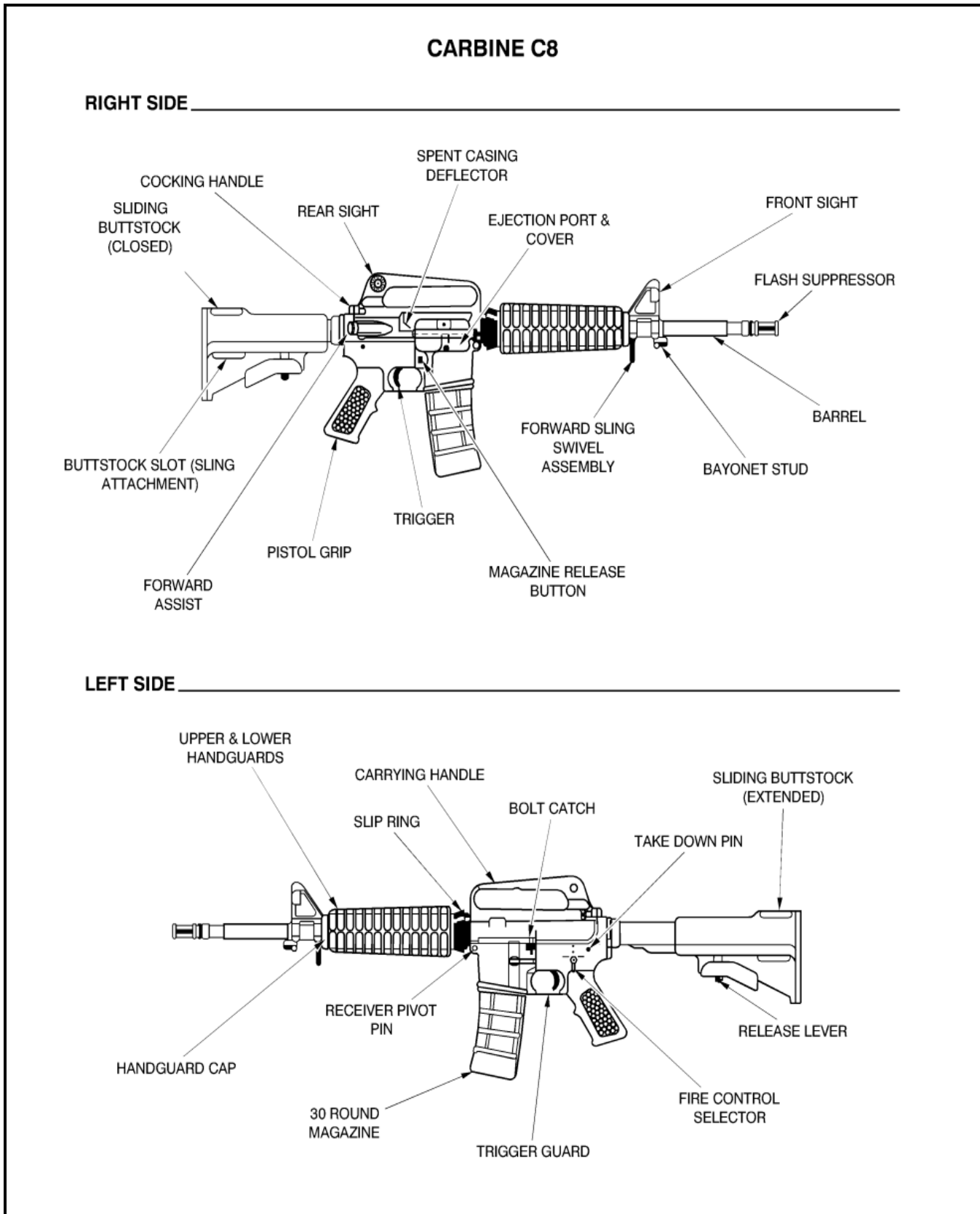

Figure 5-1-3 C8 Carbine

GROUND ARMS FROM THE SHOULDER

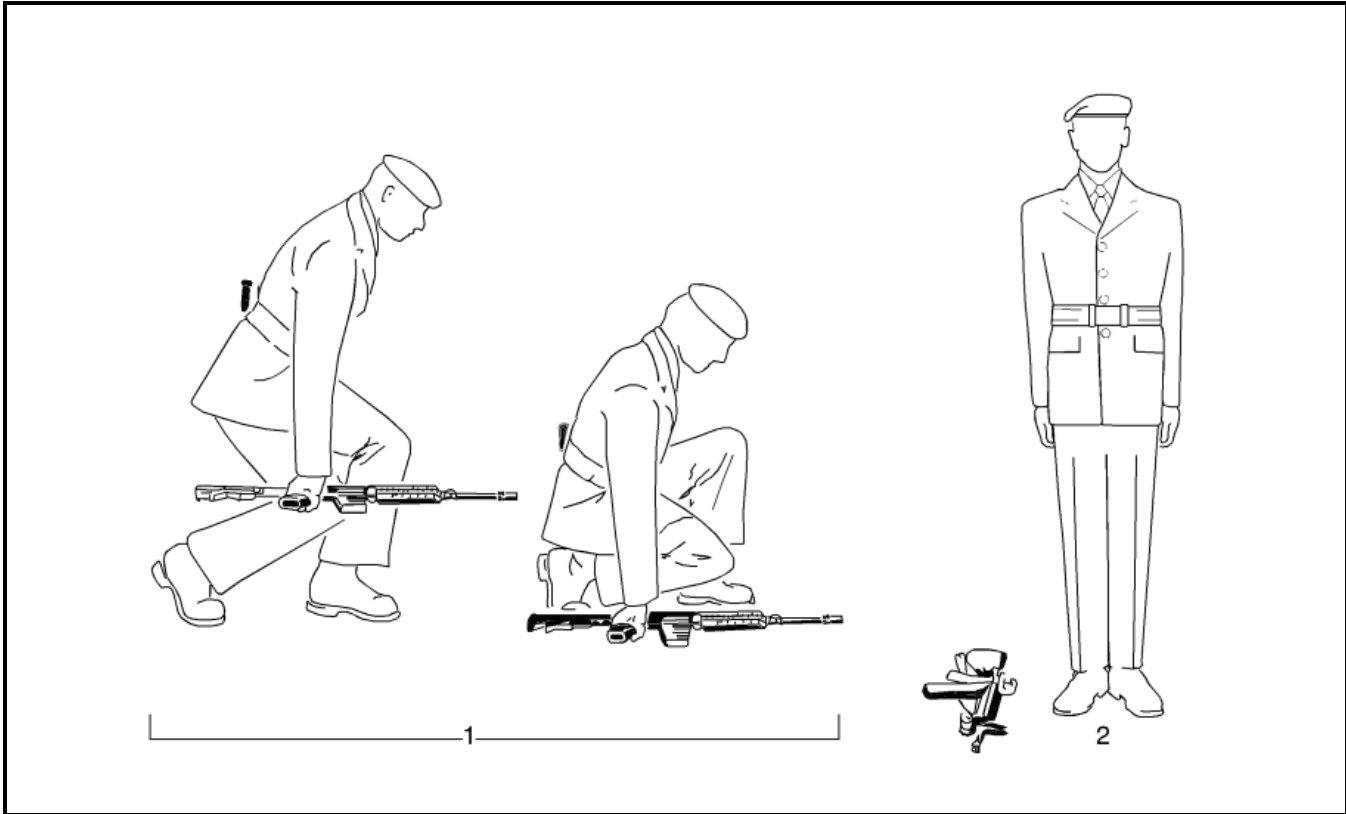

Figure 5-1- 4 Ground Arms from the Shoulder

10. On the command GROUND ARMS BY NUMBERS, SQUAD – ONE, squad members shall:
 - a. take a half pace forward with the left foot and, by bending the knees, adopt a squatting position (Figure 5-1-4);
 - b. simultaneously, lay the carbine on the ground at the right side with the magazine to the right and the muzzle pointing straight to the front, keeping the right arm vertical and the right hand in line with the right knee;
 - c. keep the shoulders square to the front and look down at the carbine; and
 - d. keep the left arm straight against the body and hip.
11. On the command SQUAD – TWO, squad members shall:
 - a. release the carbine; and
 - b. assume the position of attention by standing erect, bending the left knee and bringing the left foot back to the right foot.
12. On the command GROUND – ARMS, the two movements are combined. A standard pause is observed between the movements.

TAKE UP ARMS

13. On the command TAKE UP ARMS BY NUMBERS, SQUAD – ONE, squad members shall:

- a. take a half pace forward with the left foot and, by bending the knees, adopt a squatting position;
 - b. looking down, grasp the carbine at the pistol grip with the right hand; and
 - c. keep the left arm straight against the body and hip.
14. On the command SQUAD – TWO, squad members shall assume the position of attention by:
- a. standing erect, bending the left knee and bringing the left foot smartly back to the right; and
 - b. simultaneously, bringing the carbine to the right side, adopting the proper position of attention.
15. On the command TAKE UP – ARMS, the two movements are combined. A standard pause shall be observed between the movements.

DRESSING A SQUAD

16. When dressing a squad on parade with carbines, the squad shall be at the shoulder arms (attention) position and the movements shall be executed in similar manner to those for rifle drill.

ORDERING A SQUAD WITH CARBINES ON PARADE

17. The detail shall be similar to that for rifle drill except that carbines are not brought to the order arms position.

FIX BAYONETS

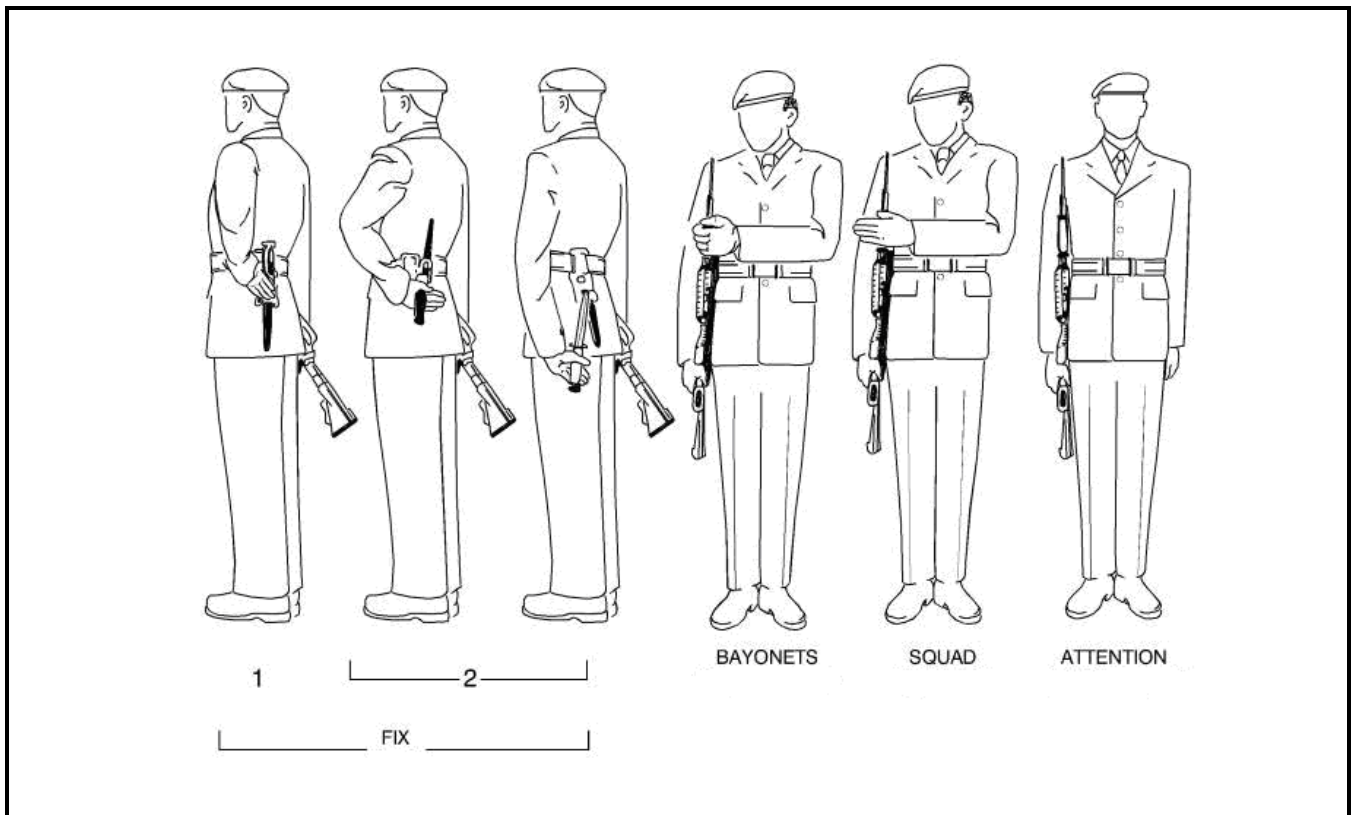

Figure 5-1-5 Fix Bayonets

18. The squad shall be in the open order when fixing bayonets.
19. On the command SQUAD WILL FIX BAYONETS, BY NUMBERS, SQUAD – ONE, squad members shall:

- a. tilt the carbine forward with the right hand to an angle of 45 degrees (Figure 5-1-5); and
 - b. simultaneously, grasp the bayonet handle with the thumb around the ring and fingers around the handle.
20. On the command SQUAD – TWO, squad members shall:
- a. rotate the bayonet anti-clockwise; and
 - b. withdraw the bayonet by straightening the left arm with the bayonet being held along the left buttock, not visible from the front and with the fingers extended down the side of the bayonet handle.
21. On the command SQUAD WILL FIX BAYONETS – FIX, the two movements are combined.
22. On the command BAYONETS BY NUMBERS, SQUAD – ONE, squad members shall:
- a. lower the head to look directly at the muzzle of the carbine; and
 - b. simultaneously, bring the bayonet between the body and the arm and fix the bayonet on the carbine by first fitting the bayonet ring over the muzzle and then fitting the groove in the bayonet handle over the bayonet stud on the carbine.
23. On the command SQUAD – TWO, squad members shall push the bayonet down until the catch engages.
24. On the command SQUAD, BAYONETS, the two movements are combined. A standard pause shall be observed between movements.
25. On the command SQUAD, squad members shall open the palm of the left hand and strike the handle of the bayonet with the fingers and thumb together and extended in continuation of the line of the arm and the thumb below the cross piece (guard) of the bayonet.
26. On the command SQUAD, ATTEN – TION, squad members shall:
- a. pull the carbine to the right side and assume the shoulder arms position; and
 - b. cut the left arm to the left side and raise the head to assume the position of attention.

UNFIX BAYONETS

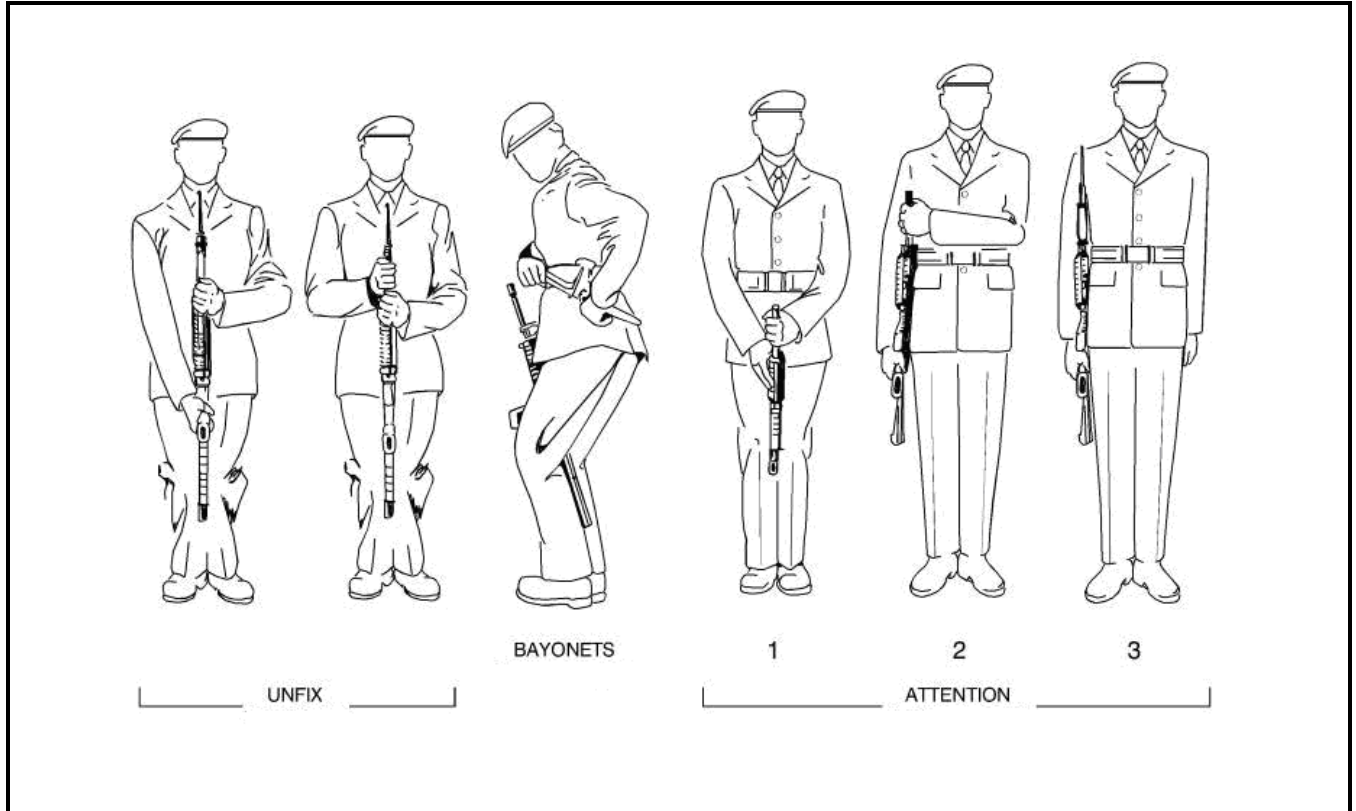
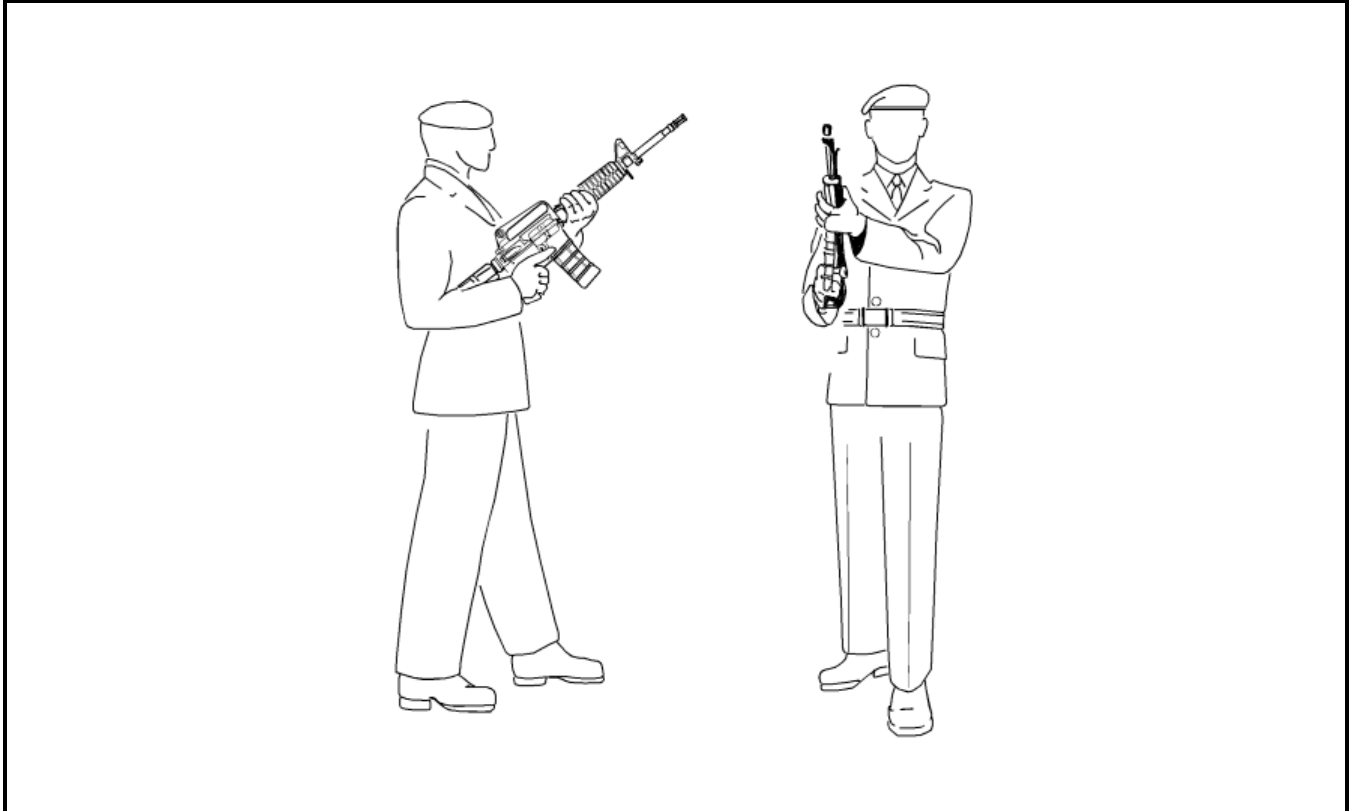

Figure 5-1-6 Unfix Bayonets

27. On the command SQUAD WILL UNFIX BAYONETS BY NUMBERS, SQUAD – ONE, squad members shall:
- with the right hand, carry the carbine to the front centre of the body (Figure 5-1-6);
 - bending the knees slightly, grip the carbine between the knees; knees gripping the carbine at a point between the pistol grip and the magazine; and
 - strike and grasp the carbine with the left hand immediately below the bayonet handle with the thumb and forefinger pressing in on the bayonet catch.
28. On the command SQUAD – TWO, release the carbine with the right hand and grasp the bayonet handle with an upward movement, forcing the bayonet ring just clear of the carbine barrel with the blade edge to the front, the bayonet in line with the weapon barrel.
29. On the command SQUAD WILL UNFIX BAYONETS – UNFIX, the movements are combined. A standard pause shall be observed between the movements.
30. On the command BAYONETS BY NUMBERS, SQUAD – ONE, squad members shall:
- with a flick of the right wrist, turn the bayonet over to the left so that the flat of the blade strikes the belt;
 - grasp the scabbard with the left hand, tilting the scabbard and inserting the point of the bayonet into the mouth of the scabbard; and
 - simultaneously, bend the head downward and to the left to look at the scabbard.
31. On the command SQUAD – TWO, squad members shall:

- a. force the bayonet fully home in the scabbard;
 - b. keep the left elbow straight to the rear;
 - c. keep the right elbow close to the body; and
 - d. keep the fingers of the right hand closed and extended downward over the bayonet handle.
32. On the command SQUAD, BAYONETS, the two movements are combined. A standard pause shall be observed between the movements.
33. On the command ATTENTION BY NUMBERS, SQUAD – ONE, squad members shall:
- a. strike and grasp the carbine at the pistol grip with the right hand;
 - b. simultaneously, release the scabbard with left hand, strike and grasp the carbine at the barrel below the flash suppressor; and
 - c. turn the head and eyes to the front.
34. On the command SQUAD – TWO, squad members shall:
- a. force the weapon to the shoulder arms position with both hands, guiding the weapon into the shoulder with the left hand; and
 - b. simultaneously, straighten the knees to the position of attention.
35. On the command SQUAD – THREE, squad members shall cut the left hand and arm to the side assuming the position of attention.
36. On the command SQUAD, ATTEN – TION, the three movements are combined. A standard pause shall be observed between the movements.

EXAMINE ARMS FROM THE SHOULDER**Figure 5-1-7 Examine Arms from the Shoulder**

37. On the command FOR INSPECTION, EXAMINE ARMS BY NUMBERS, SQUAD – ONE, squad members shall:
- keeping the head and body square to the front, take a half pace forward with the left foot (Figure 5-1-7); and
 - thrust the carbine forward with the right hand to an angle of 45 degrees and strike and grasp the handguard immediately in front of the magazine with the left hand, the sling in the palm of the left hand.
38. On the command SQUAD – TWO, squad members shall remove the right hand from the pistol grip and grasp the cocking handle with the index and middle fingers.
39. On the command SQUAD – THREE, squad members shall, with the right hand:
- pull the working parts to the rear; and
 - return the cocking handle to its normal position.
40. On the command SQUAD – FOUR, squad members shall return the right hand to the pistol grip, right forefinger along the trigger guard.
41. On the command SQUAD – FIVE, squad members shall remove the left hand from the handguard, ensure the fire control selector is on “S” and return the left hand to the handguard.
42. On the command FOR INSPECTION, EXAMINE – ARMS, the five movements are combined. The standard pause shall be observed between the movements.

EASE SPRINGS

43. On the command EASE SPRINGS BY NUMBERS, SQUAD – ONE, squad members shall:
 - a. remove the left hand from the handguard; and
 - b. strike the side of the magazine with the fingers around the forward edge of the magazine and the left thumb over the bolt catch.
44. On the command SQUAD – TWO, squad members shall push the bolt in the bolt catch with the thumb of the left hand.
45. On the command SQUAD – THREE, squad members shall move the fire control selector to “R” with the thumb and forefinger of the left hand.
46. On the command SQUAD – FOUR, squad members shall return the left hand to the handguard.
47. On the command SQUAD – FIVE, squad members shall press the trigger and release it.
48. On the command SQUAD – SIX, squad members shall, with the right hand, strike the right side of the magazine housing with fingers together and extended and immediately, with the index finger, close the ejection port cover (Figure 4-1-14).
49. On the command SQUAD – SEVEN, squad members shall return the right hand to the pistol grip, the right index finger along the trigger guard.
50. On the command EASE – SPRINGS, the seven movements are combined. The standard pause shall be observed between the movements.
51. DELETED.

SHOULDER ARMS FROM THE EXAMINE

Figure 5-1- 8 Shoulder Arms from the Examine

52. On the command **SHOULDER ARMS BY NUMBERS, SQUAD – ONE**, squad members shall:
- bend the left knee and assume the position of attention with the feet (Figure 5-1-8);
 - with the right hand, pull the weapon to the shoulder arms position;
 - simultaneously, with the left hand force the weapon into the right shoulder, maintaining an all-round grasp of the handguard with the left hand; and
 - keep the weapon vertical to the ground.
53. On the command **SQUAD – TWO**, squad members shall:
- cut the left hand to the side by the shortest route; and
 - force the weapon back until the thumb of the right hand is in line with the trouser seam.
54. On the command **SHOULDER – ARMS**, the two movements are combined. The standard pause shall be observed between the movements.
55. When rifles and carbines are mixed on parade and the command to order arms from the examine is given, personnel carrying carbines shall remain still for the standard pause whilst personnel armed with rifles execute the first movement of the order arms, (Chapter 4, paragraph 87). Thereafter, those armed with carbines shall shoulder arms.
56. On other than a ceremonial parade, it is normal for each individual to ease springs, shoulder arms and stand at ease after the inspecting officer has reached the second file to the left. The last two members of the rank act together. If order arms is ordered for rifles on parade, personnel with carbines shall shoulder arms.

SHOULDER ARMS FROM THE PORT

57. Similar to rifle drill.
58. When carbines and rifles are carried at the port arms on the same parade and the command order arms is given, the following movements shall be executed by personnel carrying carbines.
59. On the command ORDER ARMS BY NUMBERS, SQUAD – ONE, personnel carrying carbines shall force the carbine to the right shoulder with the left hand.
60. On the command SQUAD – TWO, personnel shall change the position of the right hand from the sliding buttstock, to strike and grasp the pistol grip.
61. On the command SQUAD – THREE, personnel shall cut the left hand to the side and assume the position of attention.
62. On the command ORDER – ARMS, the three movements are combined. The standard pause is observed between the movements.

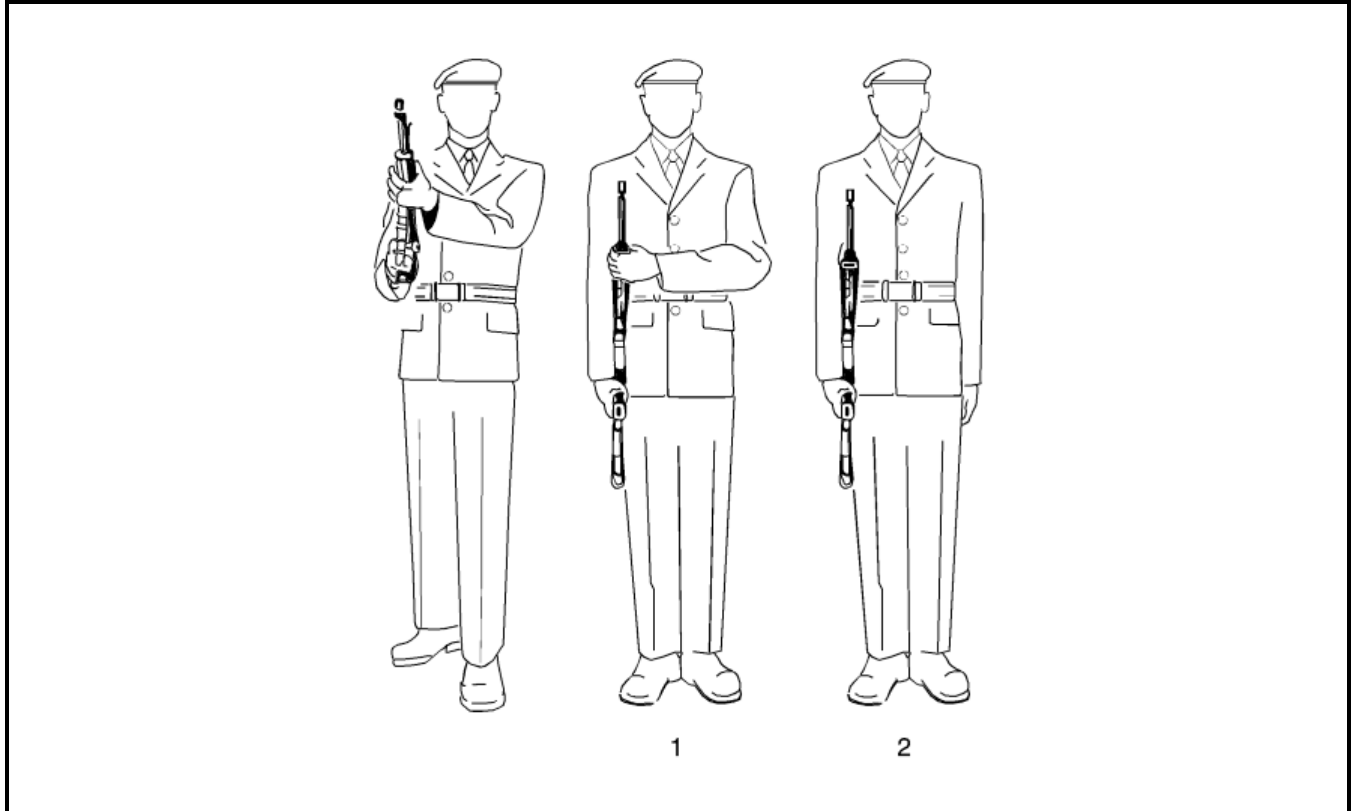
SECTION 2

CEREMONIAL CARBINE DRILL

FIRING CARTRIDGES FROM THE SHOULDER

1. Firing cartridges from the shoulder is executed in the same manner as for rifle drill, except that in the last movement carbines shall be returned to the shoulder in the same manner as for the shoulder arms from the examine.

FIRING VOLLEYS – MILITARY FUNERALS

2. The procedure for firing volleys at a military funeral shall be the same as for rifle drill, except as noted below.

3. On the completion of the service and after the parade commander has ordered parade replace headdress, the guard/firing party commander shall give the same sequence of commands as detailed for rifle drill except that the command order arms shall not be given when only carbines are carried.

NOTE

A five seconds pause shall be observed between volleys, otherwise orders at sub-subparagraphs 41.b. (4), (5) and (6), section 2, chap. 4 are repeated until three blank rounds have been fired.

REVERSE ARMS FROM THE SHOULDER

4. The reverse arms shall be executed in the same manner as that for rifle drill, except for the fourth movement, which shall be as follows. On the command SQUAD – FOUR, squad members shall release the handguard with the left hand and transfer the left hand behind the back grasping the barrel just in front of the front sight, the back of the hand towards the ground.

CHANGE ARMS AT THE REVERSE

5. The change arms from the reverse shall be executed in the same manner as that for rifle drill, except for the fourth movement, which shall be as follows. On the command SQUAD – FOUR, squad members shall force the right arm around and behind the body, the right hand grasping the barrel in front of the front sight, the back of the hand towards the ground.

CHAPTER 6**SWORD, PACE STICK AND CANE DRILL****SECTION 1****SWORD DRILL****GENERAL**

1. The sword (Figure 6-1-1) is one of the traditional badges of rank for those who hold Her Majesty's commission or warrant. It is worn as a ceremonial weapon by officers and chief warrant officers. It may also be worn by non-commissioned members of units which by custom have armed personnel with swords, such as horse-mounted cavalry and horse artillery.

2. The sword is worn for the following occasions:

- a. on formal ceremonies or parades;
- b. at state ceremonies;
- c. in attendance on or as escorts to Royal or Vice-Regal personages;
- d. for ceremonial guards, including guards of honour;
- e. for church services or parades;
- f. for military or state funerals;
- g. at formal inspections by flag and general officers who are reviewing officers, or their aides de camp;
- h. as a representative of the Canadian Forces at formal civilian functions;
- i. at investitures in accordance with the investing dignitary's customs and wishes; and
- j. for social occasions, less dinners and dances, for which No. 1, 1B or 1C order of dress is appropriate.

CHAPITRE 6**EXERCICE AVEC LE SABRE,
LE MESURE-PAS ET LA CANNE****SECTION 1****EXERCICE AVEC LE SABRE****GÉNÉRALITÉS**

1. Le sabre (figure 6-1-1) est l'un des signes distinctifs traditionnels de grade, des personnes qui détiennent une commission ou un brevet de Sa Majesté. C'est une arme de cérémonie portée par les officiers et les adjudants-chefs. Dans certaines unités aux coutumes particulières, comme la cavalerie et l'artillerie à cheval, il peut également être porté par des militaires du rang.

2. Les militaires autorisés portent le sabre dans les occasions suivantes :

- a. dans les cérémonies ou rassemblements officiels;
- b. dans les cérémonies d'État;
- c. lorsqu'ils sont de service auprès de personnages royaux ou vice-royaux ou qu'ils font partie de leur escorte;
- d. lorsqu'ils font partie de cérémonie, y compris les gardes d'honneur;
- e. lors des services religieux ou de rassemblements à l'église;
- f. lorsqu'ils prennent part à des funérailles d'État ou à des funérailles militaires;
- g. aux inspections officielles, par des généraux qui agissent à titre d'officier de revue ou par leurs aides de camp;
- h. lorsqu'ils participent à des cérémonies civiles à titre de représentants des Forces canadiennes;
- i. lors d'investitures, conformément aux vœux du dignitaire concerné et aux coutumes qu'il entend observer; et
- j. dans les réunions sociales, à l'exception des dîners et des soirées dansantes, où sont de mise les tenues n° 1, 1B ou 1C.

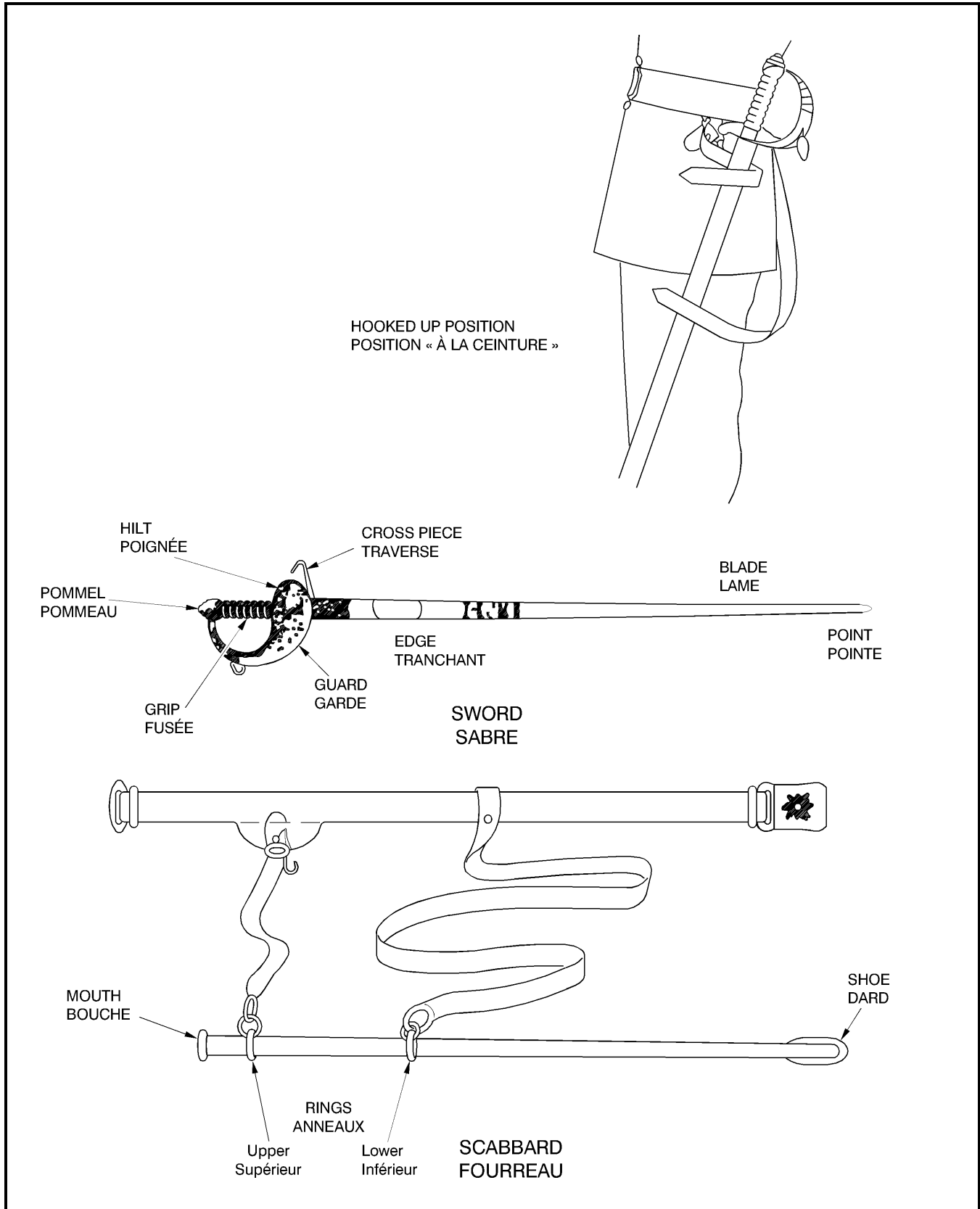

Figure 6-1-1 Sword and Accoutrements
Figure 6-1-1 Le sabre et ses attributs

3. Accuracy and swift but graceful movements are the hallmarks of good sword handling.

4. There are two methods of wearing the sword:

a. hooked-up, which may be used by anyone and is always used by personnel who must keep the left hand free for use, e.g., Colour bearers, band conductors and drum-majors; and

b. slung.

5. The sword may be drawn and returned when either in the hooked-up or slung position. Once the sword is drawn the actual sword movements are the same for all.

6. In the interest of uniformity, parade commanders may issue instructions for scabbards to be either hooked-up or slung.

7. When parading under their own arrangements, commanding officers may order slung scabbards to be hooked-up under jackets once swords are drawn. If so, the parade must pause while personnel are given a few moments to hook-up or unhook scabbards.

8. Colour bearers will wear the sword hooked-up. If the sword belt is worn under the tunic, jacket or overcoat, this is achieved by having a slit made in the coat and lining at the pocket opening so that the drawn sword blade can pass down through the garment slit and into the mouth of the scabbard which is hooked-up underneath.

9. When on the march, the sword is always held at the carry position with three exceptions:

a. when troops are ordered to sling weapons, swords will be returned to their scabbard;

b. when Colours are sloped or when troops are marching at ease, swords will be sloped; and

3. Un bon maniement du sabre se caractérise par des mouvements à la fois vifs, précis et gracieux.

4. Le sabre se porte de deux façons :

a. à la ceinture, cette façon pouvant être adoptée par n'importe qui et étant obligatoire pour ceux qui doivent garder la main gauche libre, par exemple les porte-drapeaux consacrés, les chefs de musique et les tambours-majors; et

b. suspendu.

5. Le dégainement et la remise en place du sabre peuvent se faire dans les deux positions, soit porté à la ceinture ou suspendu. Une fois le sabre dégainé, les mouvements sont les mêmes pour tous.

6. Par souci d'uniformité, les commandants de défilés ou de rassemblements peuvent émettre des directives précisant la façon de porter le fourreau.

7. Lorsque les commandants d'unité organisent eux-mêmes un rassemblement, ils peuvent ordonner à leur personnel de ramener le fourreau de la position suspendue à la position à la ceinture sous la veste, une fois le sabre dégainé. Dans ce cas, il faut prévoir un arrêt de quelques instants pour permettre aux participants d'agrafer ou de déagrafer le fourreau.

8. Chez les porte-drapeaux consacrés, le sabre se porte à la ceinture. Si le ceinturon est porté sous la tunique, sous la veste ou sous le paletot, le vêtement en question et sa doublure sont percés d'une fente à l'ouverture de la poche pour qu'on puisse y diriger la lame du sabre dans la bouche du fourreau.

9. En marche, les militaires tiennent toujours le sabre dans la position sabre en main, sauf dans les trois circonstances suivantes :

a. quand ils reçoivent l'ordre de mettre leur arme à la bretelle, ils doivent rengainer leur sabre;

b. quand le drapeau consacré est porté à l'épaule ou quand les militaires marchent au repos, le sabre se porte à l'épaule; et

c. when arms are reversed during funeral processions, swords will be reversed.

10. At the halt, the sword is normally at the carry when personnel are at attention or at the shoulder arms position.

11. When officers are ordered to fall in, they will come to attention and draw their swords before stepping off. When ordered to fall out, they will salute the senior officer, return their swords and fall out behind that officer.

12. Except where otherwise noted, non-commissioned members do not draw their swords on parade unless they are members of horse-mounted cavalry or artillery.

POSITION OF ATTENTION

13. **Sword Hooked-up.** When the sword is worn in the hooked-up position, i.e., hung on the belt hook (Figure 6-1-2), it is allowed to hang at its natural angle, hilt to the rear behind the left elbow, guard to the rear, shoe and rings of the scabbard forward; the left hand to the side in the normal position of attention. The belt hook should be positioned just to the rear of the point of the left hip so that the sword will sit naturally, without colliding with the left arm. Practice will reveal the best spot on the hip.

14. **Sword Slung.** The scabbard is held in the left hand with the left arm straight, hand gripping the scabbard at the upper ring index finger pointed down, fingers and thumb curled around the back, and the thumb in line with the seam of the trousers (Figure 6-1-2). The scabbard shall be held vertical, rings to the rear (thus, if the sword is in the scabbard, the guard is forward).

c. dans les cortèges funèbres, lorsque les armes sont renversées.

10. À la halte, les militaires tiennent généralement le sabre dans la position sabre en main lorsqu'ils sont dans la position du garde-à-vous ou dans la position à l'épaule armes.

11. Lorsque les officiers reçoivent l'ordre de former les rangs, ils prennent la position du garde-à-vous et dégainent leur sabre avant de se mettre en marche. Lorsqu'ils reçoivent l'ordre de rompre les rangs, ils saluent l'officier supérieur, rengainent leur sabre et rompent les rangs derrière cet officier.

12. Sauf indication contraire, les militaires du rang ne dégainent pas à l'occasion des rassemblements, à moins de faire partie de la cavalerie ou de l'artillerie à cheval.

POSITION DU GARDE-À-VOUS

13. **Le sabre à la ceinture.** Lorsqu'il est porté à la ceinture, c'est-à-dire retenu par l'agrafe du ceinturon (figure 6-1-2), le sabre peut être accroché de façon à pendre normalement, la poignée derrière le coude gauche du porteur, la garde vers l'arrière, le dard et les anneaux du fourreau vers l'avant. La main gauche est posée sur le côté, dans la position normale du garde-à-vous. L'agrafe doit être placée juste à l'arrière de la pointe de la hanche gauche, de façon à ce que le sabre tombe bien sans heurter le bras gauche. C'est à l'usage que chacun découvre le point de fixation approprié pour l'agrafe.

14. **Le sabre suspendu.** Le militaire, gardant le bras gauche tendu, tient le fourreau de la main gauche à la hauteur de l'anneau supérieur, l'index pointé vers le sol, les doigts et le pouce repliés vers l'arrière et le pouce en ligne avec la couture du pantalon (figure 6-1-2). Le fourreau est tenu à la verticale, les anneaux vers l'arrière (si le sabre est dans le fourreau, la garde se trouve vers l'avant).

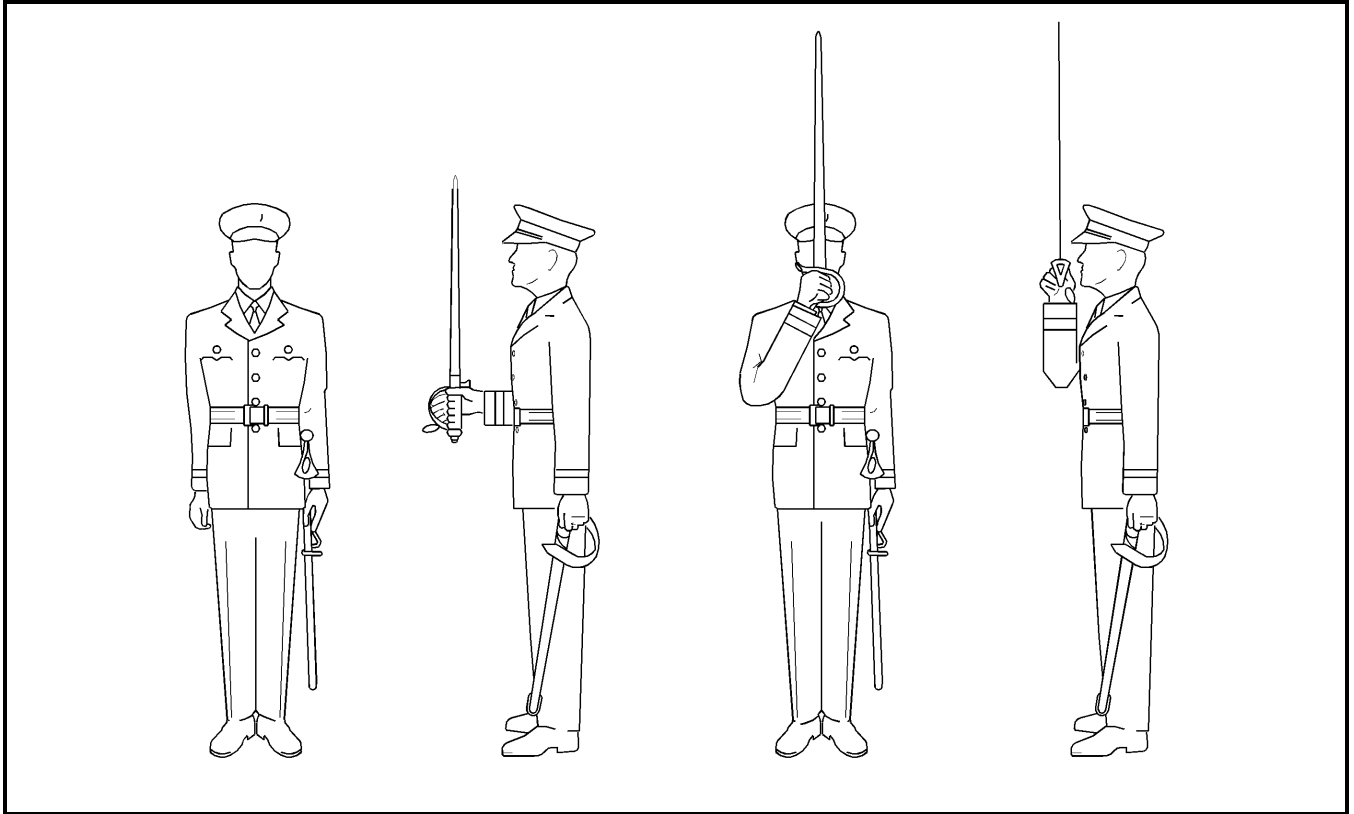

Figure 6-1-2 Attention (slung), Carry, Recover

Figure 6-1-2 Positions garde-à-vous (sabre suspendu), sabre en main et replacez le sabre

THE CARRY

15. In the carry position (Figure 6-1-2), the sword is held in the right hand with the:

- a. point up;
- b. blade perpendicular, edge to the front;
- c. grip held lightly between the forefinger and thumb, fingers together, extended to give balance and slightly cupped, hilt resting, balanced, on top of the hand;
- d. forearm horizontal to the ground and to the front;
- e. right elbow close to the body; and
- f. scabbard in the position of attention, as for hooked-up or slung position.

POSITION SABRE EN MAIN

15. À la position sabre en main (figure 6-1-2), le sabre est tenu avec la main droite et :

- a. la pointe du sabre est dirigée vers le haut;
- b. la lame est perpendiculaire au sol, le tranchant vers l'avant;
- c. le pouce et l'index serrent légèrement la fusée, les autres doigts sont réunis et tendus pour garder l'équilibre et ils sont quelque peu recourbés et la poignée repose en équilibre sur le dessus de la main;
- d. l'avant-bras est parallèle au sol et dirigé vers l'avant;
- e. le coude droit est serré contre le corps; et
- f. le fourreau est porté à la ceinture ou suspendu, comme à la position du garde-à-vous.

THE RECOVER

16. In the recover position (Figure 6-1-2), the sword is gripped in the right hand with the:

- a. point up;
- b. blade perpendicular, edge to the left;
- c. cross-piece in line with and 2 cm opposite the mouth;
- d. right elbow close to the body and the forearm perpendicular;
- e. thumb towards the mouth on the side of the grip; and
- f. left hand and scabbard in the position of attention.

NOTE

The majority of drill movements with the sword are based on the recover and carry positions. To effectively master these movements/positions, instructors should consider having trainees adopt and practice the movement between these two positions in a repetitive manner.

STAND AT EASE

17. On the command STAND AT – EASE:

- a. bend the left knee and carry the left foot normally to the left; and
- b. if the sword is in the scabbard, keep the right hand at the side of the body; or
- c. if the sword is drawn, simultaneously keep the right forearm horizontal and allow the blade to rest on the right shoulder so that the back of the blade rests midway between the neck and the point of the shoulder. Keep the forearm and hand still, but release the

FAÇON DE REPLACER LE SABRE

16. À la position replacez le sabre (figure 6-1-2), le sabre est empoigné de la main droite. Cette position peut se décrire comme suit :

- a. la pointe du sabre est dirigée vers le haut;
- b. la lame est perpendiculaire au sol, le tranchant vers la gauche;
- c. la traverse est alignée sur la bouche, à 2 cm de celle-ci;
- d. le coude droit est serré contre le corps et l'avant-bras est perpendiculaire;
- e. le pouce se trouve sur le côté de la fusée et pointe vers la bouche; et
- f. la main gauche et le fourreau sont placés comme à la position du garde-à-vous.

NOTA

La majorité des mouvements exécutés avec le sabre dérivent des positions sabre en main et replacez le sabre. Pour perfectionner ces mouvements et positions, les instructeurs peuvent faire adopter ces positions et pratiquer les mouvements transitoires entre les deux de façon répétitive.

POSITION EN PLACE REPOS

17. Au commandement « EN PLACE, RE — POS » :

- a. fléchir le genou gauche et déplacer le pied gauche à une distance normale vers la gauche; et
- b. si le sabre est dans son fourreau, garder le bras droit près du corps; ou
- c. si le sabre est au clair, garder l'avant-bras droit horizontal et, en même temps, appuyer la lame sur l'épaule droite de manière à ce que le dos de la lame se trouve à mi-chemin entre la base du cou et la pointe de l'épaule. Garder l'avant-bras et la main immobiles,

grip with the last three fingers and put the little finger behind the handle. (This is called the slope position; see Figure 6-1-3. The slope is adopted only from the carry.)

mais relâcher la prise des trois derniers doigts et placer le petit doigt derrière la poignée du sabre. C'est ce qu'on appelle la position à l'épaule. Cette position, illustrée à la figure 6-1-3, ne peut être adoptée qu'à partir de la position sabre en main.

STAND EASY

18. The body is relaxed. If the sword is drawn, its point may be lowered to the ground between the toes after a standard pause in order to rest the arm. The sword is returned to the slope position on the command SQUAD.

POSITION REPOS

18. Détendre le corps. Si le sabre est au clair, on peut en ramener la pointe au sol, entre les pieds, après une pause réglementaire afin de reposer le bras. Reprendre la position à l'épaule au commandement « ESCOUADE ».

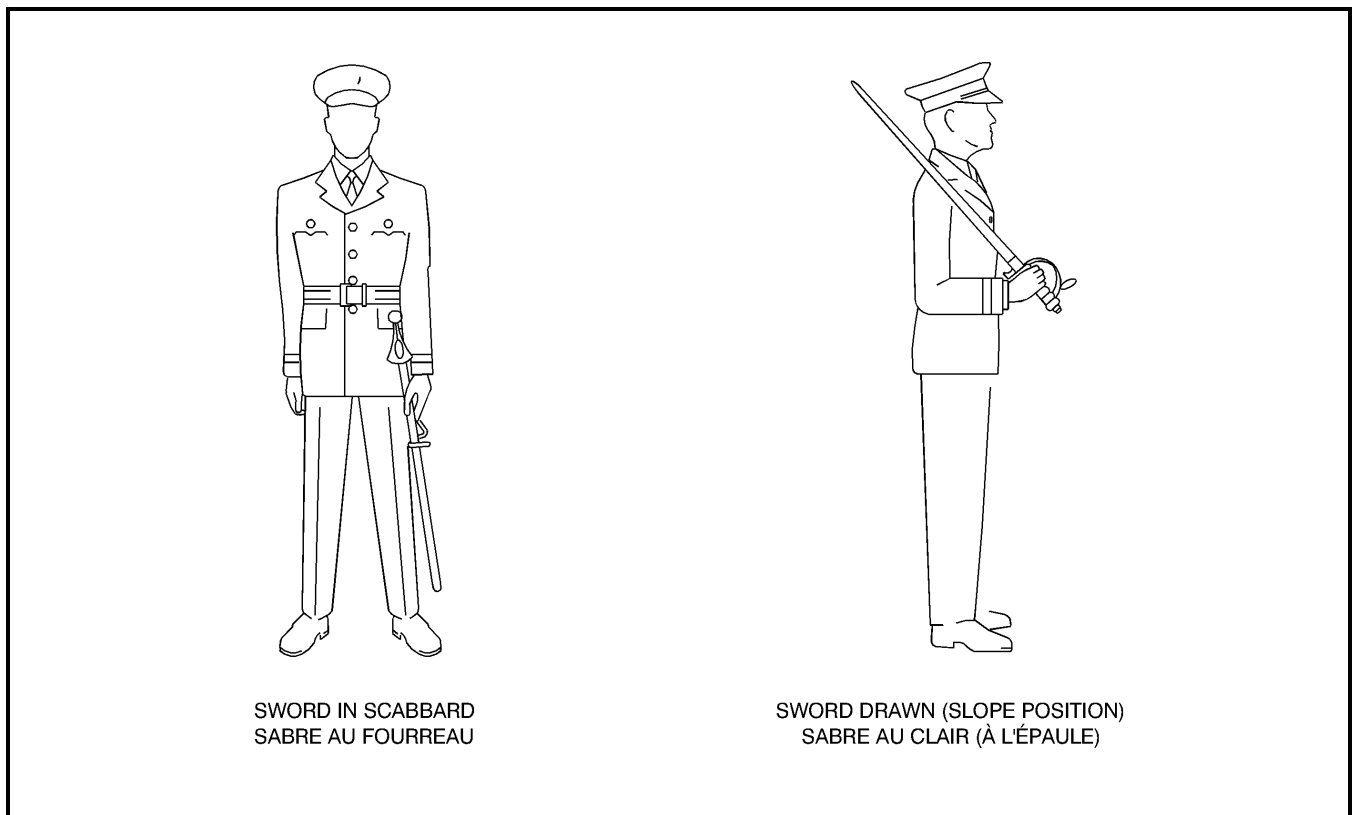

Figure 6-1-3 Stand at Ease
Figure 6-1-3 Position en place repos

ATTENTION FROM STAND AT EASE

19. On the command ATTEN – TION, bend the left knee and move the left foot sharply to the position of attention while, if the sword is drawn, simultaneously returning the sword to the carry position.

DE LA POSITION EN PLACE REPOS À LA POSITION DU GARDE-À-VOUS

19. Au commandement « GARDE-À — VOUS », fléchir le genou gauche et ramener vivement le pied gauche à la position du garde-à-vous. Si le sabre est au clair, reprendre en même temps la position sabre en main.

DRAW SWORDS

20. **Sword Hooked-up.** On the command DRAW SWORDS BY NUMBERS, SQUAD – ONE:

- a. with the left hand, grasp the top of the scabbard with an all-round grip above the upper ring, rotating the scabbard vertically to bring the guard forward, the left elbow to the rear (Figure 6-1-4); and
- b. simultaneously, reach across the body with the right hand and grasp the grip, with the back of the hand to the rear (with naval swords, release the catch with the right thumb).

21. On the command SQUAD – TWO, partially draw the blade vertically from the scabbard until the right forearm is parallel to the ground at shoulder level.

22. On the command SQUAD – THREE, draw the sword fully from the scabbard and come to the recover position. At the same time flick the scabbard to its natural position (rings to the front) and adopt the position of attention with the left hand.

23. On the command SQUAD – FOUR, bring the sword to the carry.

24. On the command DRAW – SWORDS, the four movements are combined. A standard pause shall be observed between the movements.

25. **Sword Slung.** On the command DRAW SWORDS BY NUMBERS, SQUAD – ONE:

- a. with the left hand, rotate the scabbard to bring the mouth forward, maintaining the grip with the left hand; and
- b. simultaneously, reach across the body with the right hand, forearm horizontal, and grasp the grip, with the back of the hand to the rear (with naval swords release the catch with the right thumb).

FAÇON DE DÉGAINER

20. **Si le sabre est à la ceinture.** Au commandement « EN DÉCOMPOSANT, DÉGAINEZ, ESCOUADE — UN » :

- a. entourer de la main gauche la partie supérieure du fourreau, au-dessus de l'anneau supérieur, et tourner le fourreau verticalement de façon à ramener la garde vers l'avant, en gardant le coude gauche vers l'arrière (figure 6-1-4); et
- b. en même temps, saisir la fusée avec la main droite en gardant le dos de la main vers l'arrière (s'il s'agit d'un sabre de la marine, dégager le cran d'arrêt avec le pouce droit).

21. Au commandement « ESCOUADE — DEUX », sortir partiellement la lame du fourreau à la verticale jusqu'à ce que l'avant-bras droit se trouve à la hauteur des épaules, parallèle au sol.

22. Au commandement « ESCOUADE — TROIS », dégainer le sabre complètement et adopter la position replacez le sabre. Repousser en même temps le fourreau à sa position naturelle (les anneaux vers l'avant) et placer la main gauche comme à la position du garde-à-vous.

23. Au commandement « ESCOUADE — QUATRE », prendre la position sabre en main.

24. Au commandement « DÉGAI — NEZ », les quatre mouvements sont combinés. On doit observer des pauses réglementaires entre les mouvements.

25. **Si le sabre est suspendu.** Au commandement « EN DÉCOMPOSANT, DÉGAINEZ, ESCOUADE — UN » :

- a. avec la main gauche, tourner et tenir le fourreau de façon à ramener la bouche vers l'avant; et
- b. en même temps, saisir la fusée avec la main droite, en gardant l'avant-bras parallèle au sol et le dos de la main vers l'arrière (s'il s'agit d'un sabre de la marine, dégager le cran d'arrêt avec le pouce droit).

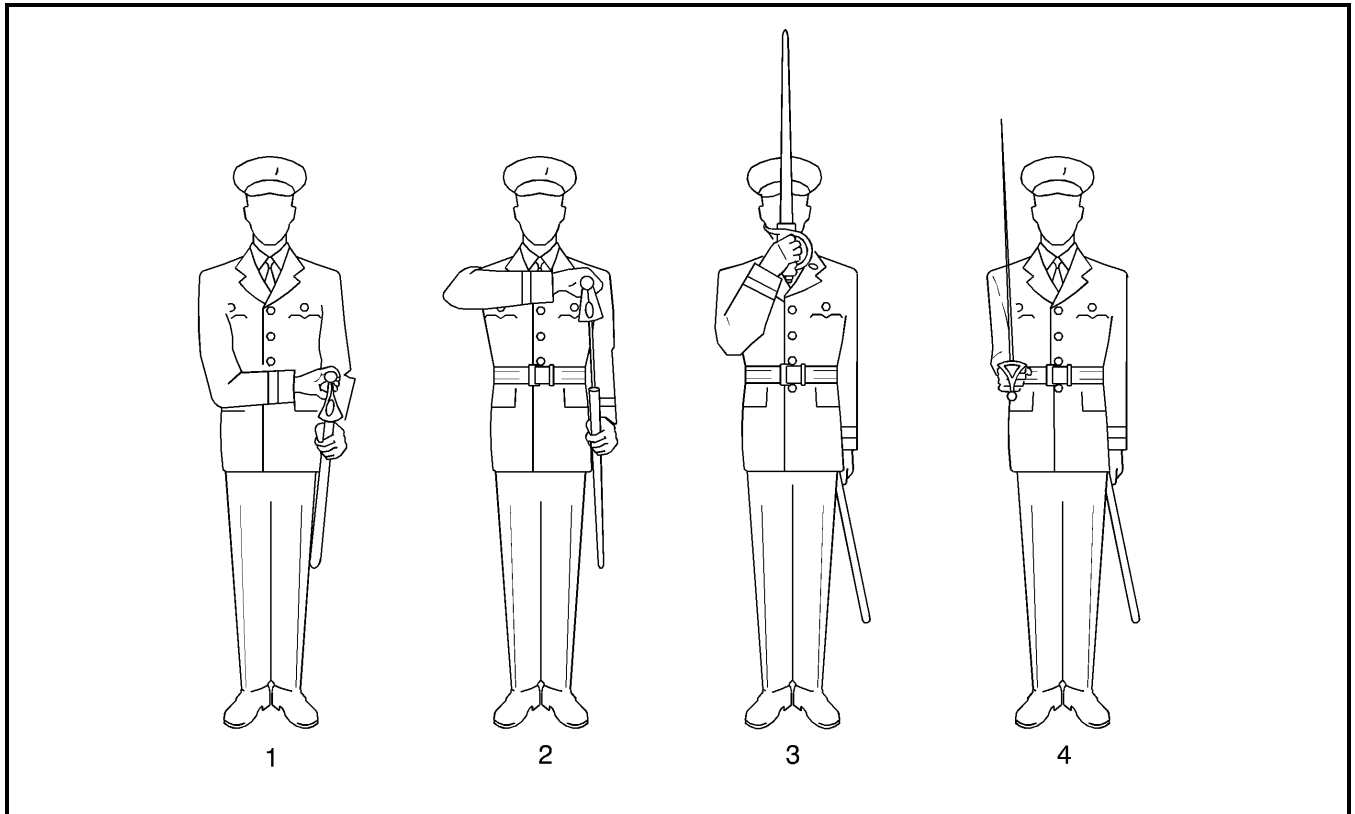

Figure 6-1-4 Draw Swords (scabbard hooked-up)
 Figure 6-1-4 Façon de dégainer (avec le fourreau à la ceinture)

26. On the command SQUAD – TWO, partially draw the blade vertically from the scabbard, until the right arm is parallel to the ground at shoulder level.

27. On the command SQUAD – THREE, draw the sword fully from the scabbard and come to the recover position. Simultaneously, rotate the scabbard to the vertical position of attention.

28. On the command SQUAD – FOUR, bring the sword to the carry position.

29. On the command DRAW – SWORDS, the four movements are combined. A standard pause shall be observed between the movements.

NOTE

When swords are drawn in connection with other personnel fixing bayonets, movements shall be coordinated, with one movement completed on each executive word of command.

26. Au commandement « ESCOUADE — DEUX », sortir partiellement la lame du fourreau à la verticale en élevant le bras droit jusqu'à la hauteur des épaules, parallèle au sol.

27. Au commandement « ESCOUADE — TROIS », dégainer le sabre complètement et adopter la position replacez le sabre. Pivoter en même temps le fourreau vers l'arrière, à la verticale, comme dans la position du garde-à-vous.

28. Au commandement « ESCOUADE — QUATRE », prendre la position sabre en main.

29. Au commandement « DÉGAI — NEZ », les quatre mouvements sont combinés. Il faut observer des pauses réglementaires entre les mouvements.

NOTA

Lorsque le dégainement des sabres se fait en même temps que la fixation des baïonnettes par d'autres militaires, les mouvements doivent être coordonnés et chaque mouvement doit suivre le commandement d'exécution approprié.

RETURN SWORD FROM THE CARRY

30. **Scabbard Hooked-up.** On the command RETURN SWORD BY NUMBER, SQUAD – ONE:

- a. with the right hand carry the hilt smartly to the hollow of the left shoulder, with the guard to the left and in line with the left shoulder, the blade perpendicular, right forearm horizontal and back of the hand and elbow to the front (Figure 6-1-5); and
- b. simultaneously, grasp the scabbard with the left hand, in an all-round grip above the upper ring, rotating the scabbard clockwise so that the rings are to the rear.

31. On the command SQUAD – TWO:

- a. lower the head to glance at the scabbard; and
- b. rotate the point of the sword to the rear outside the left shoulder until the blade is parallel to the left side of the body, turning the fingers so that the guard is facing the front. Then, raise the sword and insert the point into the mouth of the scabbard and force the blade down to assume the relative position of the second movement of draw swords. Keep the shoulders square to the front.

32. On the command SQUAD – THREE, force the sword fully home into the scabbard to assume the relative position of the first movement of draw swords.

33. On the command SQUAD – FOUR, assume the position of attention. As the left hand returns to the side give the scabbard a flick to ensure that the sword twists back to the correct position.

34. On the command RETURN – SWORDS, the four movements are combined. A standard pause shall be observed between the movements.

FAÇON DE RENGAINER LE SABRE DE LA POSITION SABRE EN MAIN

30. **Le fourreau à la ceinture.** Au commandement « EN DÉCOMPOSANT, SABRE AU FOURREAU, REMETTEZ, ESCOUADE — UN » :

- a. avec la main droite, amener vivement la poignée au creux de l'épaule gauche, en tenant la garde vers la gauche et en ligne avec l'épaule gauche, la lame perpendiculaire au sol, l'avant-bras droit à l'horizontale et le dos de la main ainsi que le coude vers l'avant (figure 6-1-5); et
- b. en même temps, saisir le fourreau de la main gauche refermée au-dessus de l'anneau supérieur et tourner le fourreau dans le sens des aiguilles d'une montre de telle sorte que les anneaux soient dirigés vers l'arrière.

31. Au commandement « ESCOUADE — DEUX » :

- a. abaisser la tête de façon à voir le fourreau; et
- b. tourner la pointe du sabre vers l'arrière, vers l'extérieur de l'épaule gauche, pour que la lame se trouve parallèle au côté gauche du corps, et tourner les doigts de manière à diriger la garde vers l'avant; relever ensuite le sabre, en insérer la pointe dans la bouche du fourreau et enfoncer la lame vers le bas pour arriver à peu près à la position correspondant au deuxième mouvement du dégainement. Garder les épaules bien droites sans tourner le corps.

32. Au commandement « ESCOUADE — TROIS », enfoncer complètement le sabre dans le fourreau de façon à retrouver la position correspondant au premier mouvement du dégainement.

33. Au commandement « ESCOUADE — QUATRE », adopter la position du garde-à-vous. En retournant le bras gauche sur le côté, repousser légèrement le fourreau avec la main pour s'assurer qu'il est revenu à la position voulue.

34. Au commandement « SABRE AU FOURREAU, REMET — TEZ », les quatre mouvements sont combinés. On doit observer des pauses réglementaires entre les mouvements.

35. **Scabbard Slung.** On the command RETURN SWORD BY NUMBERS, SQUAD – ONE:

- a. with the right hand, carry the hilt smartly to the hollow of the left shoulder, with the guard to the left and in line with the left shoulder, the blade perpendicular right forearm horizontal, and back of the hand and elbow to the front; and
- b. simultaneously, with the left hand, pivot the mouth of the scabbard forward.

36. On the command SQUAD – TWO:

- a. lower the head to glance at the scabbard; and
- b. rotate the point of the sword to the rear outside the left shoulder until the blade is parallel to the left side of the body, turning the fingers so that the guard is facing the front. Then, raise the sword and insert the point into the mouth of the scabbard and force the blade down to assume the relative position of the second movement of draw swords. Keep the shoulders square to the front.

37. On the command SQUAD – THREE, force the sword fully home into the scabbard to assume the relative position of the first movement of draw swords.

38. On the command SQUAD – FOUR, assume the position of attention.

39. On the command RETURN – SWORDS, the four movements are combined. A standard pause shall be observed between the movements.

35. **Le sabre suspendu.** Au commandement « EN DÉCOMPOSANT, SABRE AU FOURREAU, REMETTEZ, ESCOUADE — UN » :

- a. avec la main droite, amener vivement la poignée au creux de l'épaule gauche, en tenant la garde vers la gauche et en ligne avec l'épaule gauche, la lame perpendiculaire au sol, l'avant-bras droit à l'horizontale et le dos de la main ainsi que le coude vers l'avant; et
- b. en même temps, faire pivoter de la main gauche la bouche du fourreau vers l'avant.

36. Au commandement « ESCOUADE — DEUX » :

- a. abaisser la tête de façon à voir le fourreau; et
- b. tourner la pointe du sabre vers l'arrière, vers l'extérieur de l'épaule gauche, pour que la lame se trouve parallèle au côté gauche du corps, et tourner les doigts de manière à diriger la garde vers l'avant; relever ensuite le sabre, en insérer la pointe dans la bouche du fourreau et enfoncer la lame vers le bas pour arriver à peu près à la position correspondant au deuxième mouvement du dégainement. Garder les épaules bien droites sans tourner le corps.

37. Au commandement « ESCOUADE — TROIS », enfoncer complètement le sabre dans le fourreau de façon à retrouver la position correspondant au premier mouvement du dégainement.

38. Au commandement « ESCOUADE — QUATRE », adopter la position du garde-à-vous.

39. Au commandement « SABRE AU FOURREAU, REMET — TEZ », les quatre mouvements sont combinés. On doit observer des pauses réglementaires entre les mouvements.

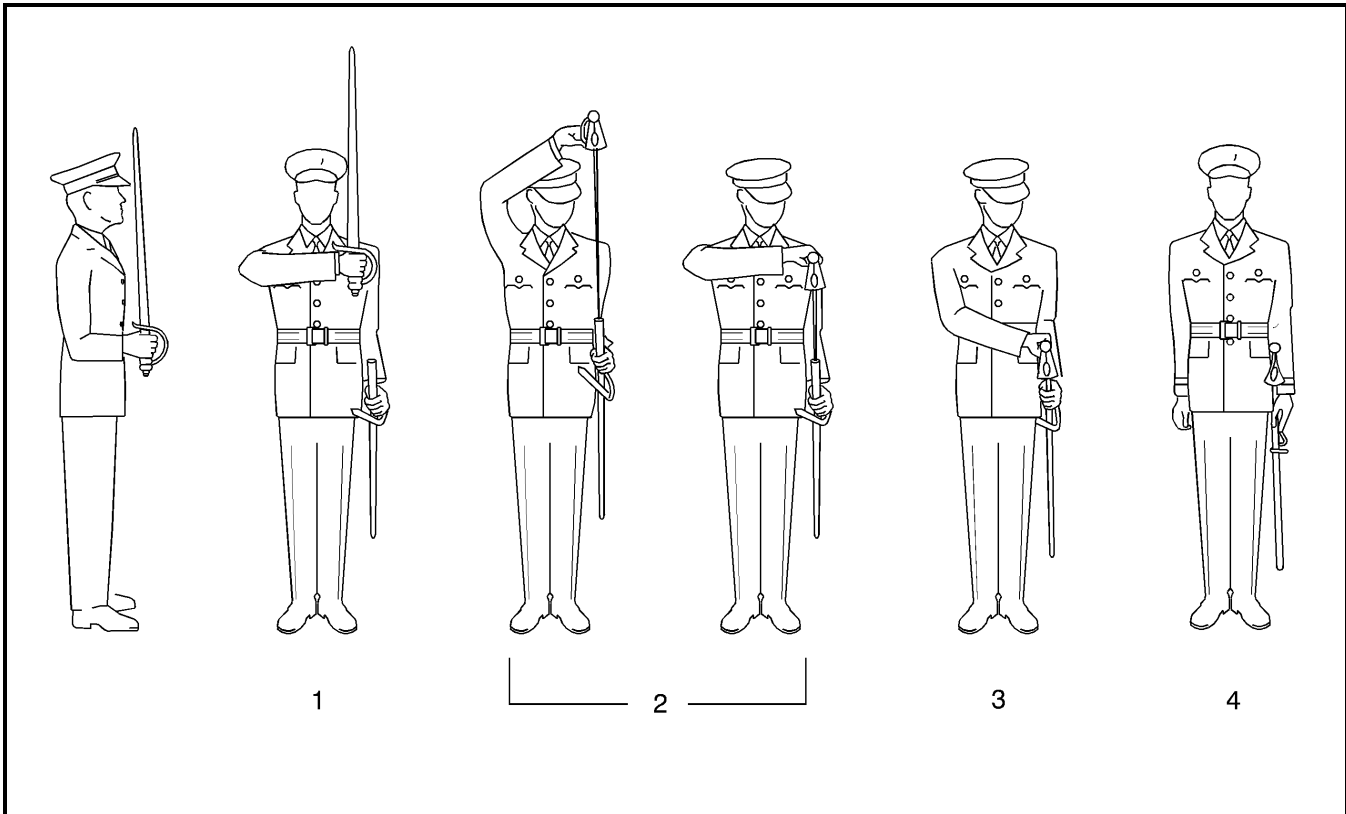

Figure 6-1-5 Return Swords from the Carry

Figure 6-1-5 Façon de rengainer le sabre de la position sabre en main

NOTES

1. When swords are returned in connection with other personnel unfixing bayonets, movements shall be coordinated, with the first two movements of returning swords completed on the commands UNFIX and BAYONETS, and the last two movements with the two movements of ATTEN – TION.
2. If scabbards have been hooked-up beneath jackets, the scabbard must be unhooked quickly prior to commencing the first movement of the return swords.

NOTA

1. Lorsque des militaires rengainent leurs sabres en même temps que d'autres remettent leurs baïonnettes au fourreau, il doit y avoir coordination des mouvements. Les deux premiers mouvements du sabre au fourreau remettez sont complétés aux commandements « REMET — TEZ » et « BAÏONNETTES », tandis que les deux derniers mouvements correspondent aux deux mouvements nécessaires pour adopter la position du garde-à-vous.
2. Si des militaires ont leur fourreau agrafé à la ceinture, sous la veste, ils doivent le dégrafer rapidement avant d'exécuter le premier mouvement de la remise en place du sabre.

MARCHING WITH SWORD IN/OUT OF SCABBARD

40. **Quick March.** On the command QUICK – MARCH, step off normally and:

- a. **Scabbard Hooked-up.** Swing both arms if sword is sheathed (Figure 6-1-6A).
- b. **Scabbard Slung.** Rotate the shoe of the scabbard forward, with the guard up when the sword is sheathed, until the scabbard is held at an angle of 45 degrees, and change the left hand to an all-round grip at the upper ring. Swing the right arm when sword is sheathed (Figure 6-1-6). The left arm shall be kept still at the side.

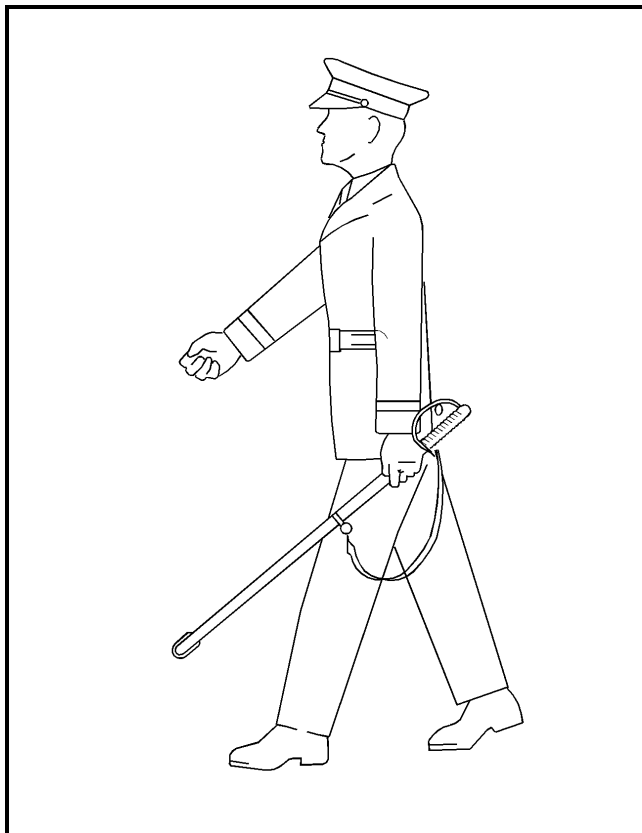

Figure 6-1-6 Quick March (slung)
Figure 6-1-6 Pas cadencé (suspendu)

MARCHER AVEC LE SABRE AU FOURREAU/HORS DU FOURREAU

40. **Marche au pas cadencé.** Au commandement « PAS CADENCÉ — MARCHÉ », se mettre en marche normalement :

- a. **Fourreau à la ceinture.** Si le sabre est rengainé, balancer les deux bras (figure 6-1-6A).
- b. **Fourreau suspendu.** Pousser le fourreau de façon à ramener le dard vers l'avant. Si le sabre est engainé, la garde est dirigée vers le haut. Une fois le fourreau incliné à 45 degrés, modifier la position de la main gauche de façon à la refermer complètement sur le fourreau à la hauteur de l'anneau supérieur. Balancer le bras droit si le sabre est au fourreau (figure 6-1-6). Garder le bras gauche immobile le long du corps.

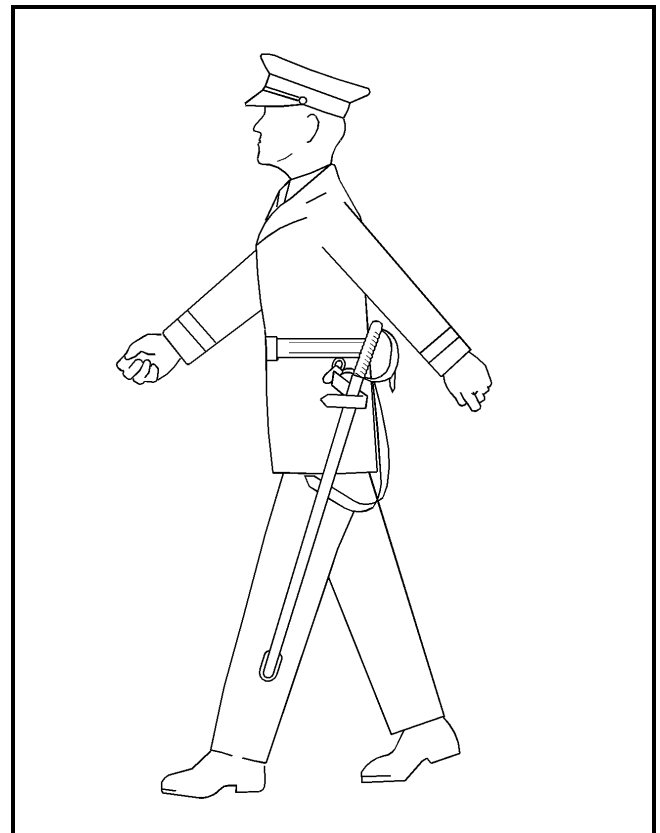

Figure 6-1-6A Quick March (hooked up)
Figure 6-1-6A Pas cadencé (à la ceinture)

- c. **March at Ease.** When the sword is drawn, change the position of the sword from the carry to the slope position, or return the sword if rifles are ordered slung. On the command MARCH AT ATTENTION, return to the carry.
- d. **Colours Sloped.** When Colours are ordered to the slope, drawn swords shall also be ordered to the slope.

41. **Slow March.** On the command SLOW – MARCH, step off normally. If the scabbard is slung, rotate the shoe of the scabbard forward and hold the scabbard with the left hand as in subparagraph 40.b. above. Swords are never sloped during the slow march.

HALT

- 42. On the command SQUAD – HALT:
 - a. halt normally; and
 - b. if the scabbard is slung, as the right knee is straightened into attention, bring the scabbard to the vertical position and assume the position of attention.

SALUTING AT THE HALT

- 43. On the command TO THE FRONT SALUTE BY NUMBERS, SQUAD – ONE, bring the sword to the recover (Figure 6-1-7).
- 44. On the command SQUAD – TWO:
 - a. lower the sword sharply to the right side to the full extent of the right arm, sword angled downward straight to the front, thumb flat along the handle fingers gripping it, so the point is 15 cm above the ground;
 - b. the edge of the blade is to the left and in line with the outside of the right foot; and

- c. **Marche au repos.** Si le sabre est au clair, passer de la position sabre en main à la position à l'épaule ou rengainer le sabre si l'ordre est donné de porter le fusil à la bretelle. Au commandement « MARCHER AU GARDE-À – VOUS », reprendre la position sabre en main.
- d. **Drapeau consacré à l'épaule.** Quand il est ordonné de porter le drapeau consacré à l'épaule, le sabre au clair se porte aussi de la même façon.

41. **Marche au pas ralenti.** Au commandement « PAS RALENTI – MARCHÉ », se mettre en marche normalement. Si le fourreau est suspendu, le pivoter de façon à ramener le dard vers l'avant et tenir le fourreau de la main gauche de la façon indiquée au sous-paragraphe 40.b. ci-dessus. On ne porte jamais le sabre à l'épaule en marchant au pas ralenti.

HALTE

- 42. Au commandement « ESCOUADE – HALTE » :
 - a. s'arrêter de la façon normale; et
 - b. si le fourreau est suspendu, le ramener à la verticale tout en redressant le genou droit et adopter la position du garde-à-vous.

SALUT À LA HALTE

- 43. Au commandement « EN DÉCOMPOSANT, SALUT VERS L'AVANT, ESCOUADE – UN », amener le sabre à la position replacez le sabre (figure 6-1-7).
- 44. Au commandement « ESCOUADE – DEUX » :
 - a. abaisser vivement le sabre du côté droit en allongeant complètement le bras droit, de telle sorte que le sabre soit dirigé vers le bas et droit vers l'avant; tenir le pouce à plat sur la poignée et garder la pointe du sabre à 15 cm du sol;
 - b. tenir le tranchant de la lame vers la gauche, dans le prolongement de l'extérieur du pied droit; et

- c. the right arm is straight, with the right hand just behind the thigh.

45. On the command SQUAD – THREE, return the sword to the recover.

46. On the command SQUAD – FOUR, return the sword to the carry.

- c. garder le bras droit à sa pleine extension, la main droite à l'arrière de la cuisse.

45. Au commandement « ESCOUADE — TROIS », ramener le sabre à la position replacez le sabre.

46. Au commandement « ESCOUADE — QUATRE », ramener le sabre à la position sabre en main.

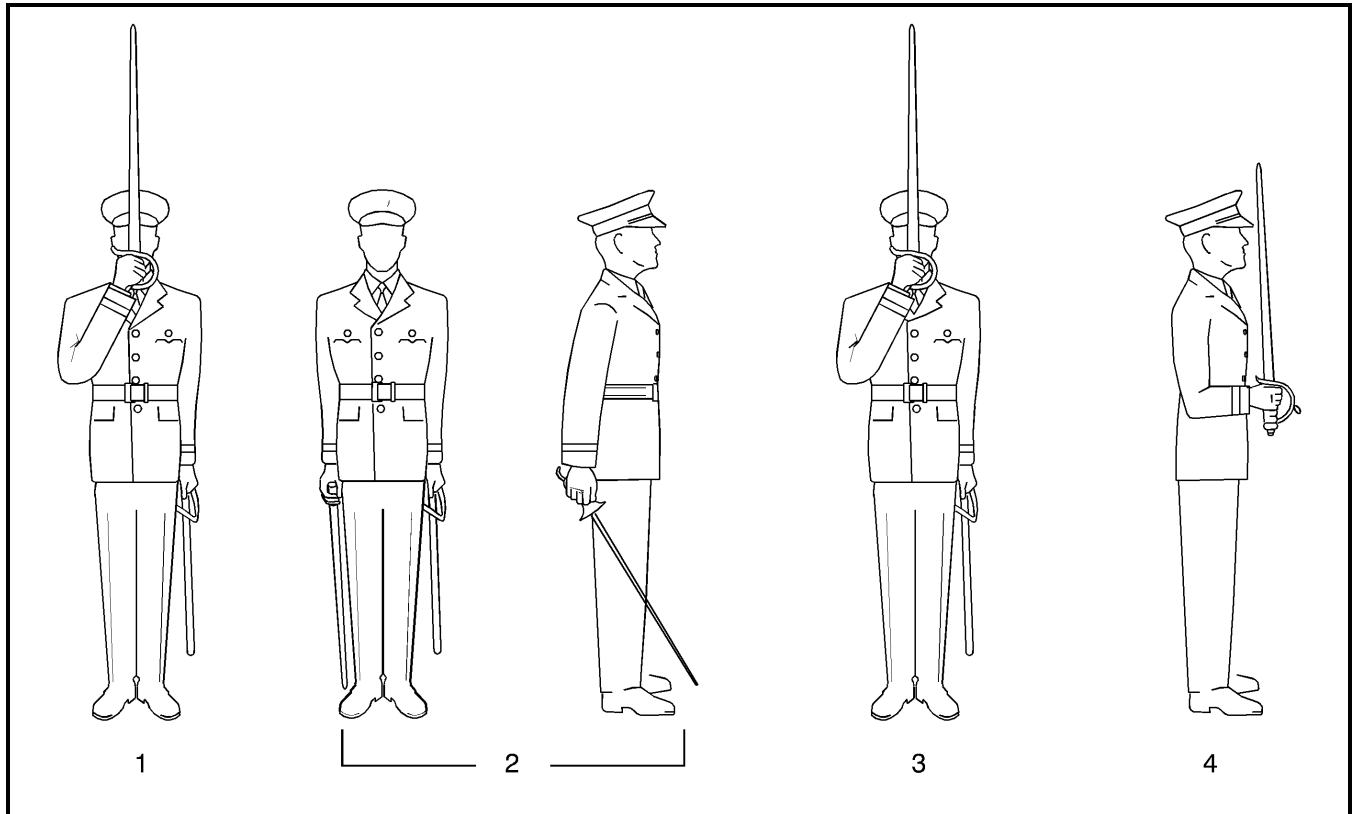

Figure 6-1-7 Saluting with the Sword

Figure 6-1-7 Salut avec le sabre

47. On the command TO THE FRONT, SALUTE, the four movements are combined. A standard pause shall be observed between the movements.

48. **Salute Coordination with Other Armed Personnel.** When the salute is executed in conjunction with personnel armed with rifles or carbines, the timing is as follows:

- a. on the first movement of the present arms from the shoulder arms, bring the sword to the recover; and

47. Au commandement « SALUT VERS L'AVANT, SALUEZ », les quatre mouvements sont combinés. On doit observer des pauses réglementaires entre les mouvements.

48. **Coordination du salut avec d'autres militaires en armes.** Le salut avec le sabre, coordonné avec d'autres militaires armés d'un fusil ou d'une carabine, se fait comme suit :

- a. au premier mouvement exécuté pour passer de la position à l'épaule armes à la position présentez armes, adopter la position replacez le sabre; et

- b. on the third movement of the present arms, lower the sword to the salute.

- b. au troisième mouvement, abaisser le sabre pour faire le salut.

49. Returning the Salute of a Junior

49. Façon de rendre le salut à un subalterne

- a. When an officer at the halt with sword drawn receives a salute, the salute is acknowledged by bringing the sword to the recover and then returning it to the carry. A standard pause shall be observed between the movements. The movement is coordinated with the last two movements of the subordinate's salute. When the sword is sheathed, salutes shall be given and returned with the hand as in drill without arms.
- b. The recover is used as an acknowledgement only when returning the salute of a junior. It is never used as a replacement for the full salute at other times (see also paragraph 58).

- a. Pour rendre un salut, l'officier à la halte portant le sabre au clair adopte successivement la position replacez le sabre puis la position sabre en main tout en observant la pause réglementaire entre les mouvements. Ce mouvement est coordonné avec les deux derniers mouvements du salut du subalterne. L'officier qui porte le sabre au fourreau salue avec la main de la même façon qu'à l'exercice sans armes.
- b. La position replacez le sabre sans autre mouvement n'est admise que pour rendre un salut à un subalterne. Elle ne peut tenir lieu de salut complet en aucune autre circonstance (voir aussi le paragraphe 58).

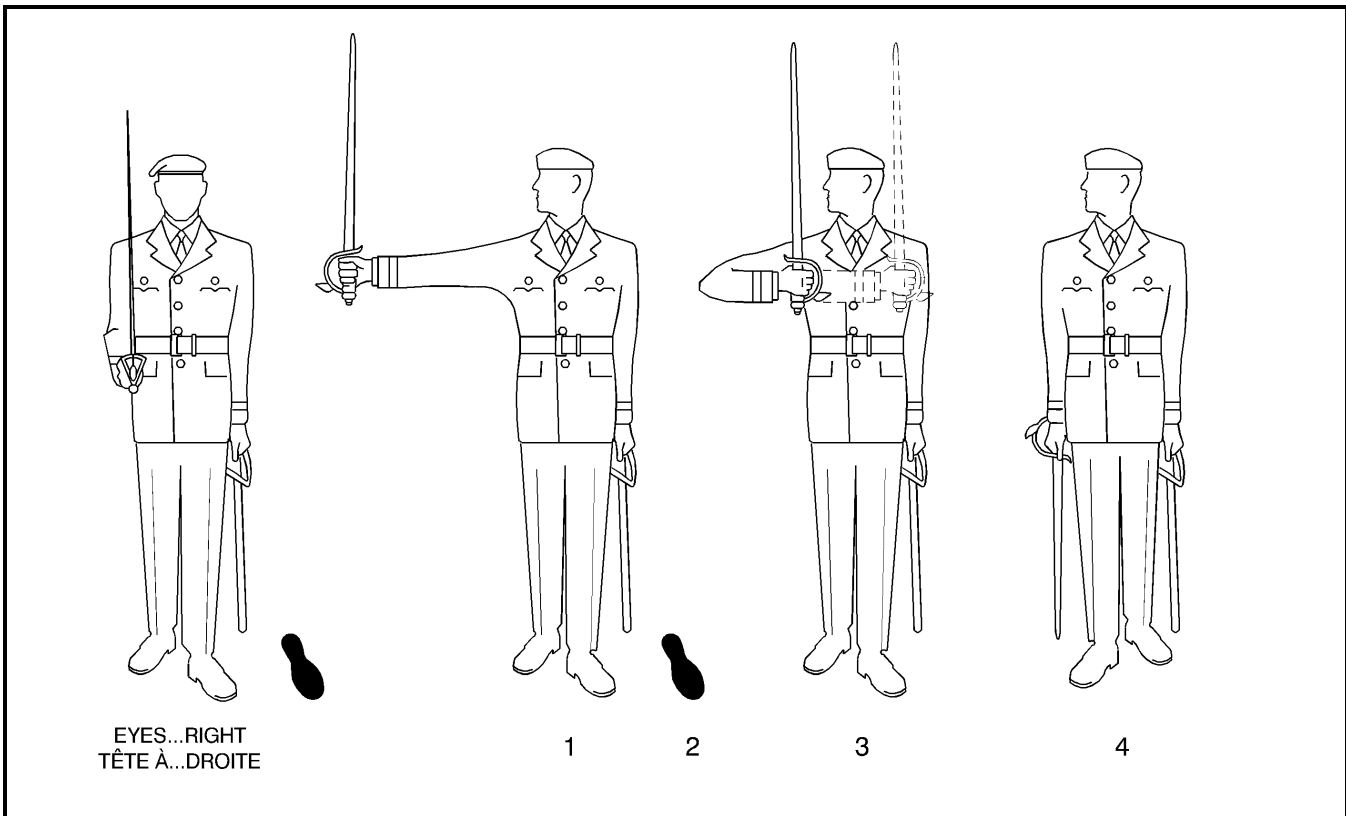

Figure 6-1-8 Saluting on the March in Slow Time
 Figure 6-1-8 Salut en marchant au pas ralenti

SALUTING ON THE MARCH IN SLOW TIME

50. On the command EYES RIGHT (LEFT) BY NUMBERS, SQUAD – ONE given as the left foot is forward and on the ground (Figure 6-1-8):

- a. take a check pace with the right foot and, when the left foot next touches the ground, shoot the right arm out to the right with the arm horizontal, at shoulder height and square off to the right, blade of the sword perpendicular with the edge to the right; and
- b. simultaneously, turn the head and eyes to the right.

51. On the command SQUAD – TWO:

- a. take a further pace with the right foot;
- b. keeping the blade perpendicular and the hand and elbow on the same plane as the shoulder, bring the sword around in a circular sweep across the body so that the crosspiece comes to the hollow of the left shoulder; and
- c. keep the elbow level with the shoulder, the thumb remaining around the grip.

52. On the command SQUAD – THREE:

- a. take a further pace with the left foot;
- b. continue the sweep back across the body until the crosspiece is in front of the right shoulder;
- c. keep the elbow at shoulder height with the upper arm in line with the shoulders; and
- d. keep the forearm horizontal.

53. On the command SQUAD – FOUR:

- a. take a further pace with the right foot;

SALUT EN MARCHANT AU PAS RALENTI

50. Au commandement « EN DÉCOMPOSANT, TÊTE À DROITE (GAUCHE), ESCOUADE — UN », donné lorsque le pied gauche est en avant et au sol (figure 6-1-8) :

- a. faire un pas de transition du pied droit et, au moment où le pied gauche touche le sol de nouveau, tendre le bras droit vers la droite, à l'horizontale, à la hauteur de l'épaule et à angle droit avec le corps, en tenant la lame du sabre perpendiculaire au sol, le tranchant vers la droite; et
- b. en même temps, tourner la tête et les yeux vers la droite.

51. Au commandement « ESCOUADE — DEUX » :

- a. faire un autre pas du pied droit;
- b. tout en gardant la lame perpendiculaire au sol et la main ainsi que le coude à la hauteur de l'épaule, amener le sabre par un mouvement circulaire vers la gauche du corps, jusqu'à ce que la traverse atteigne le creux de l'épaule gauche; et
- c. garder le coude à la hauteur de l'épaule et le pouce serré contre la poignée.

52. Au commandement « ESCOUADE — TROIS » :

- a. faire un autre pas du pied gauche;
- b. poursuivre le mouvement circulaire devant le corps en ramenant la traverse vis-à-vis de l'épaule droite;
- c. garder le coude à la hauteur des épaules avec la partie supérieure du bras en ligne avec les épaules; et
- d. garder l'avant-bras à l'horizontale.

53. Au commandement « ESCOUADE — QUATRE » :

- a. faire un autre pas du pied droit;

- b. lower the elbow to the side, changing the grip so that the thumb points up the side of the hilt; and
- c. lower the sword to the position of the salute.

54. On the command EYES – RIGHT, the four movements are carried out as one continuous graceful gesture over four paces, finishing on the right foot.

55. On the command EYES FRONT BY NUMBERS, SQUAD – ONE, which is given as the left foot is forward and on the ground:

- a. take a check pace with the right foot and, when the left foot next touches the ground, turn the head and eyes to the front; and
- b. simultaneously, bring the sword to the recover position.

56. On the command SQUAD – TWO:

- a. take two further paces; and
- b. when the left foot next is forward and on the ground, bring the sword down to the position of the carry.

57. On the command EYES – FRONT, the movements are done on successive left feet.

SALUTING ON THE MARCH IN QUICK TIME

58. On the command EYES – RIGHT (LEFT) given as the left foot is forward and on the ground:

- a. the sword is kept at the carry; and
- b. head and eyes are turned to the right (left).

59. On the command EYES – FRONT given as the left foot is forward and on the ground, head and eyes are turned to the front.

- b. abaisser le coude sur le côté et changer la façon de tenir le sabre en plaçant le pouce sur le côté de la poignée; et
- c. abaisser le sabre jusqu'à la position du salut.

54. Au commandement « TÊTE À — DROITE », les quatre mouvements sont combinés en un seul mouvement continu et gracieux qui s'effectue sur quatre pas et qui se termine avec un pas du pied droit.

55. Au commandement « EN DÉCOMPOSANT, FIXE, ESCOUADE — UN », donné au moment où le pied gauche est en avant et au sol :

- a. faire un pas de transition du pied droit et, au moment où le pied gauche touche le sol de nouveau, tourner la tête et les yeux vers l'avant; et
- b. en même temps, ramener le sabre à la position replacez le sabre.

56. Au commandement « ESCOUADE — DEUX » :

- a. faire deux autres pas; et
- b. au moment où le pied gauche est en avant et au sol, abaisser le sabre à la position sabre en main.

57. Au commandement « FIXE », exécuter les différents mouvements successivement chaque fois que le pied gauche touche le sol.

SALUT EN MARCHANT AU PAS CADENCÉ

58. Au commandement « TÊTE À — DROITE (GAUCHE) », donné au moment où le pied gauche est en avant et au sol :

- a. garder le sabre à la position sabre en main; et
- b. tourner la tête et les yeux vers la droite (gauche).

59. Au commandement « FIXE », donné lorsque le pied gauche est en avant et au sol, ramener la tête et les yeux vers l'avant.

FORMING WEDDING ARCH

60. Forming arch with the sword is a position adopted by an even-numbered group of individuals authorized to wear a sword (see paragraph 1) when forming an honorary departure guard at a wedding (non-commissioned members which by custom are not entitled to be armed with a sword shall not be used to form a wedding arch). Those designated to form the arch shall position themselves in two equal ranks, one on either side of the walk, immediately outside the church or chapel door. The ranks will be eight feet apart and facing each other. The interval is dependent on the number of persons used in relation to the desired length of the arch or the space available.

61. When in position, the senior present shall order DRAW – SWORDS and, as the bride and groom appear in the doorway, shall order FORM – ARCH (see paragraph 65).

62. When the arch is formed, the swords opposite will touch three inches from the sword points (Figure 6-1-9).

63. When the bridal party has passed through the arch, the swords shall be returned to the carry.

FORMING ARCH FROM THE CARRY

64. On the command FORM ARCH BY NUMBERS, SQUAD – ONE, bring the sword to the recover position.

65. On the command SQUAD – TWO, extend the right arm to its full extent, carrying the sword forward and upward to an angle of 45 degrees with the blade flat, edge to the right. The arm and shoulder form a straight line from the shoulder to the sword point.

66. On the command FORM – ARCH, the two movements are combined. A standard pause is observed between movements.

CARRY FROM THE ARCH

67. On the command CARRY SWORDS BY NUMBERS, SQUAD – ONE, return to the recover position.

FAÇON DE FORMER LA HAIE À L'OCCASION DES MARIAGES

60. La position dite de la haie est une position qu'adoptent des individus autorisés à porter un sabre (voir le paragraphe 1), en nombre pair, pour former une garde d'honneur à la sortie des nouveaux mariés. On ne doit pas former la haie avec des militaires du rang qui, par tradition, ne sont pas autorisés à porter le sabre. Les officiers désignés pour former la haie se placent d'eux-mêmes en deux rangs égaux de chaque côté de l'entrée de l'église ou de la chapelle. Les rangs sont à huit pieds l'un de l'autre et se font face, l'intervalle entre les officiers étant fonction du nombre d'officiers présents ainsi que de l'espace disponible.

61. Dès que les officiers sont en position, le plus haut gradé donne le commandement « DÉGAI — NEZ » et, lorsque les nouveaux mariés franchissent le portail de l'église, il donne le commandement « FORMEZ — HAIE » (voir paragraphe 65).

62. Lorsque la haie est formée, les sabres se croisent à trois pouces de la pointe (figure 6-1-9).

63. Lorsque le cortège a franchi la haie, les officiers reprennent la position sabre en main.

FAÇON DE FORMER LA HAIE DE LA POSITION SABRE EN MAIN

64. Au commandement « EN DÉCOMPOSANT, FORMEZ HAIE, ESCOUADE — UN », amener le sabre à la position replacer le sabre.

65. Au commandement « ESCOUADE — DEUX », allonger le bras droit au maximum et pointer le sabre vers le haut à un angle de 45 degrés, la lame à plat et le tranchant vers la droite. Le bras et le sabre doivent former une ligne droite depuis l'épaule jusqu'à la pointe du sabre.

66. Au commandement « FORMEZ — HAIE », les deux mouvements sont combinés. Une pause réglementaire doit être observée entre les mouvements.

DE LA POSITION DE LA HAIE À LA POSITION SABRE EN MAIN

67. Au commandement « EN DÉCOMPOSANT, SABRE EN MAIN, ESCOUADE — UN », ramener le sabre à la position replacer le sabre.

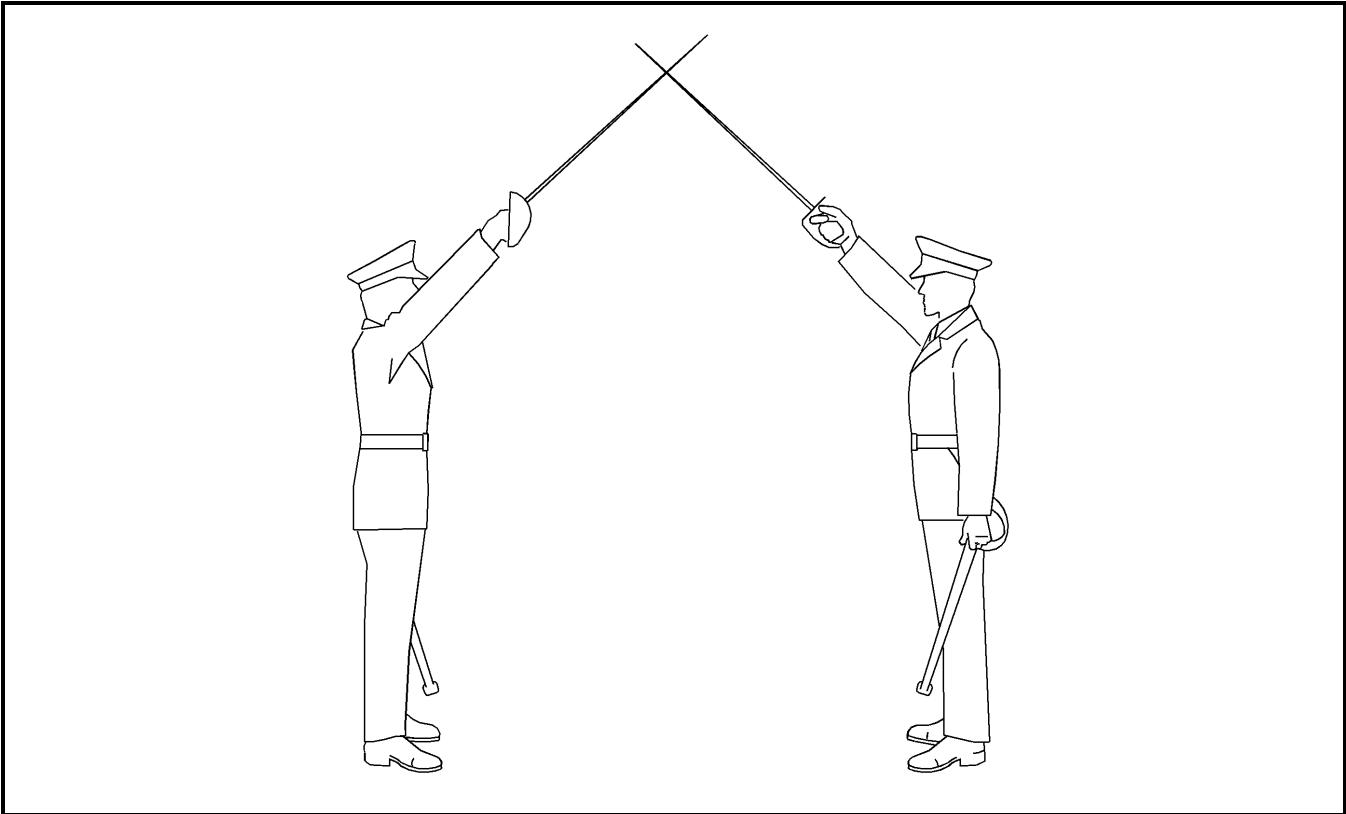

Figure 6-1-9 The Arch
Figure 6-1-9 La haie

68. On the command SQUAD – TWO, return the sword to the carry position.

69. On the command CARRY – SWORDS, the two movements are combined. A standard pause shall be observed between the movements.

REST ON YOUR ARMS REVERSED FROM THE SALUTE

70. This movement is commenced from the position of the salute, most often in conjunction with troops who have first been ordered to present arms.

71. On the command REST ON YOUR ARMS REVERSED BY NUMBERS, SQUAD – ONE, bring the sword to the recover (Figure 6-1-10).

72. On the command SQUAD – TWO:

- a. allow the point to fall forward and down, allowing the hand to rotate inward, to turn the guard to the right;

68. Au commandement « ESCOUADE — DEUX », ramener le sabre à la position sabre en main.

69. Au commandement « SABRE EN — MAIN », les deux mouvements sont combinés. Observer une pause réglementaire entre les mouvements.

DE LA POSITION DU SALUT À LA POSITION SUR VOS ARMES RENVERSÉES REPOSEZ

70. Les officiers exécutent ce mouvement la plupart du temps conjointement avec des troupes, à la suite du commandement « PRÉSENTEZ — ARMES ».

71. Au commandement « EN DÉCOMPOSANT, SUR VOS ARMES RENVERSÉES, REPOSEZ, ESCOUADE — UN », amener le sabre à la position replacez le sabre (figure 6-1-10).

72. Au commandement « ESCOUADE — DEUX » :

- a. abaisser la pointe vers l'avant en tournant la main vers l'intérieur de telle sorte que la garde soit dirigée vers la droite;

- b. place the point on the ground in line with and midway between the toes of the shoes, the guard to the right; and
- c. move the right hand so that it is resting on the pommel, elbow close to the body.

73. On the command SQUAD – THREE, place the left hand over the right, elbow close to the body, lower the head until the chin touches the chest.

74. On the command REST ON YOUR ARMS, REVERSED, the three movements are combined. A standard pause shall be observed between the movements. If the movements are performed in conjunction with those of others armed with rifles/carbines, the sword movements shall be smooth, solemn and coordinated to the standard 10-second count (Chapter 4, Section 2, paragraph 8) as follows:

- a. 1 second, SQUAD ONE completed;
- b. 9 seconds, SQUAD TWO completed; and
- c. 10 seconds, SQUAD THREE completed.

SALUTE FROM REST ON YOUR ARMS REVERSED

75. On the command TO THE FRONT SALUTE BY NUMBERS, SQUAD – ONE, squad members shall raise the head and eyes and look to the front.

76. On the command SQUAD – TWO, squad member shall:

- a. grasp the grip with the right hand, thumb pointing down on the inside; and
- b. bring the left hand to the side as for the position of attention.

77. On the command SQUAD – THREE, bring the sword to the recover, sweeping the point to the front, rotating the hand, elbow into the side.

- b. placer la pointe du sabre au sol, à égale distance des deux pieds et en ligne avec le bout des pieds, en tenant la garde vers la droite; et
- c. placer la main droite sur le pommeau en gardant le coude près du corps.

73. Au commandement « ESCOUADE — TROIS » placer la main gauche par-dessus la main droite, le coude près du corps, en penchant la tête jusqu'à ce que le menton touche la poitrine.

74. Au commandement « SUR VOS ARMES RENVERSÉES, REPOSEZ », les trois mouvements sont combinés. Observer une pause réglementaire entre les mouvements. Si ces mouvements sont coordonnés avec ceux d'autres militaires armés d'un fusil ou d'une carabine, ils doivent être exécutés avec élégance et solennité, suivant le compte réglementaire de dix secondes (paragraphe 8, section 2, chapitre 4) appliqué comme suit :

- a. à 1 seconde, fin du ESCOUADE UN;
- b. à 9 secondes, fin du ESCOUADE DEUX; et
- c. à 10 secondes, fin du ESCOUADE TROIS.

DE LA POSITION SUR VOS ARMES RENVERSÉES REPOSEZ À LA POSITION DU SALUT

75. Au commandement « EN DÉCOMPOSANT, SALUT VERS L'AVANT, ESCOUADE — UN », les membres de l'escouade relèvent la tête et les yeux et regardent droit devant eux.

76. Au commandement « ESCOUADE — DEUX » :

- a. saisir la poignée du sabre avec la main droite en tenant le pouce vers le bas et vers l'intérieur de la poignée; et
- b. placer la main gauche sur le côté comme pour la position du garde-à-vous.

77. Au commandement « ESCOUADE — TROIS », prendre la position replacez le sabre en relevant le sabre vers l'avant par un mouvement circulaire de la main et en gardant le coude près du corps.

78. On the command SQUAD – FOUR, bring the sword to the salute.

79. On the command TO THE FRONT, SA – LUTE, the four movements are combined. A standard pause, shall be observed between the movements.

78. Au commandement « ESCOUADE — QUATRE », amener le sabre à la position du salut.

79. Au commandement « VERS L'AVANT, SALU — EZ », les quatre mouvements sont combinés. Observer une pause réglementaire entre les mouvements.

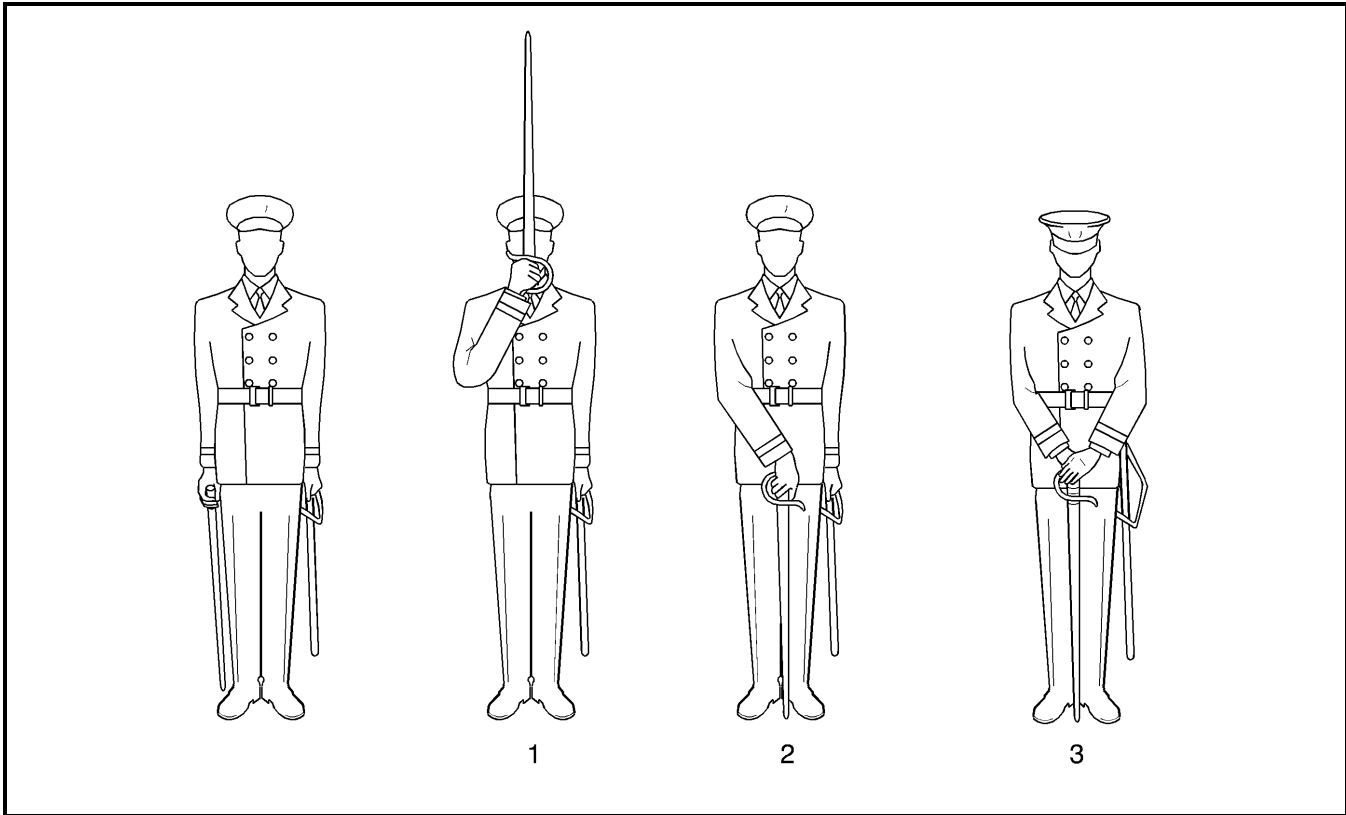

Figure 6-1-10 Rest on your Arms Reversed from the Salute

Figure 6-1-10 De la position du salut à la position sur vos armes renversées reposez

80. The movements will be performed in conjunction with movements of others armed with rifles on the command PRESENT – ARMS.

FUNERAL PROCESSIONS

81. **General.** Scabbards will be hooked up when marching in a funeral procession when arms are to be reversed.

- a. Processional troops should reverse swords/ rifles/carbines before stepping off.

80. Si ces mouvements sont coordonnés avec ceux d'autres militaires armés d'un fusil, ils sont exécutés au commandement « PRÉSENTEZ — ARMES ».

CORTÈGES FUNÈBRES

81. **Généralités.** Dans les cortèges funèbres où les participants doivent renverser leur arme, les fourreaux sont portés à la ceinture.

- a. Les militaires qui font partie d'un cortège funèbre devraient renverser leur sabre, leur fusil ou leur carabine avant de se mettre en marche.

- b. When marching in quick time, the left hand will be removed from the sword/rifle/carbine and the arm swung (see also Chapter 4, Section 2, paragraph 48). The sword hilt (rifle/carbine butt) will be allowed to drop, bringing the weapon to a horizontal position below the right armpit.
- c. Sword and hand movements are executed simply and by the shortest route.

82. **The Reverse from the Carry.** These movements are done when personnel armed with rifles/carbines reverse arms from the shoulder.

83. On the command REVERSE ARMS BY NUMBERS, SQUAD – ONE, force the sword under the right armpit, edge uppermost, by twisting the wrist and dropping the point of the sword to the left front, the hilt uppermost and coming to rest in front of the right shoulder, fingers of the right hand are together and straight and to the right of the hilt, thumb to the left, back of the hand to the right, right elbow against the side and the sword at an angle of 45 degrees (Figure 6-1-11).

84. On the command SQUAD – TWO, seize the blade with the left hand behind the back, in line with the waist belt, back of the hand underneath.

85. The Reverse from the carry (and vice versa) will be done working on the first and fourth movement of the rifles.

86. **The Carry from the Reverse.** On the command SHOULDER ARMS BY NUMBERS, SQUAD – ONE, return the left hand to the side.

87. On the command SQUAD – TWO, allow the sword to swing forward and, with a circular movement to the left, keeping the sword close to the body, adopt the position of the carry.

- b. Au pas cadencé, retirer la main gauche du sabre (ou du fusil ou de la carabine) et balancer le bras (voir aussi le paragraphe 48, de la section 2 du chapitre 4). Laisser tomber la poignée du sabre (ou encore la crosse du fusil ou de la carabine) de telle sorte que l'arme se trouve en position horizontale, sous l'aisselle droite.
- c. Exécuter tous les mouvements de la façon la plus simple et la plus directe possible.

82. **De la position sabre en main à la position renversez armes.** Les militaires qui portent le sabre exécutent ces mouvements en même temps que les militaires armés d'un fusil ou d'une carabine, lorsqu'ils passent de la position à l'épaule à la position renversez armes.

83. Au commandement « EN DÉCOMPOSANT, RENVERSEZ ARMES, ESCOUADE — UN », pousser le sabre sous l'aisselle droite, le tranchant vers le haut, en tournant le poignet et en laissant tomber la pointe du sabre vers l'avant, du côté gauche; la poignée du sabre est vers le haut, devant l'épaule droite, les doigts de la main droite sont redressés et réunis à la droite de la poignée, le pouce à gauche, le dos de la main à droite; le coude droit reste près du corps et le sabre forme un angle de 45 degrés (figure 6-1-11).

84. Au commandement « ESCOUADE — DEUX », saisir la lame de la main gauche derrière le dos, à la hauteur du ceinturon, le dos de la main dessous.

85. Pour passer de la position sabre en main à la position renversez armes (et vice versa), on coordonne les mouvements avec le premier et le quatrième mouvements des militaires portant le fusil.

86. **De la position renversez armes à la position sabre en main.** Au commandement « EN DÉCOMPOSANT, À L'ÉPAULE, ARMES, ESCOUADE — UN », ramener la main gauche sur le côté.

87. Au commandement « ESCOUADE — DEUX », laisser le sabre pivoter vers l'avant et, d'un mouvement circulaire vers la gauche, tout en gardant le sabre près du corps, prendre la position sabre en main.

88. **The Reverse when Ordered to March in Quick (Slow) Time.** On the command CHANGE INTO QUICK TIME, QUICK – MARCH, from slow time, return the left hand to the side on the first pace of quick time with the left foot, and, at the same time, allow the hilt to drop so that the sword is horizontal.

89. On the command CHANGE INTO SLOW TIME, SLOW – MARCH, resume the position of reverse arms as the left foot comes to the ground for the first pace in slow time.

90. **Change Swords at the Reverse.** (Movements are coordinated with rifle/carbine movements.) On the command CHANGE ARMS, SQUAD – ONE, return the left hand to the side and at the same time change the grip of the right hand by placing it underneath the sword grip, thumb on the right.

91. On the command SQUAD – TWO, swing the point down until the sword is vertical and pass the sword across the body into the left hand.

92. On the command SQUAD – THREE, cut the right hand to the side.

93. On the command SQUAD – FOUR, force the sword under the left armpit.

94. On the command SQUAD – FIVE, seize the blade with the right hand behind the back, back of the hand underneath, sword at an angle of 45 degrees. Simultaneously, change the position of the left hand on the handle, so that the fingers are together and straight on the left and the thumb is on the right, with the back of the hand to the left.

95. To change arms again, reverse the procedure.

POSITION WHEN SEATED

96. When seated (Figure 6-1-12), the sword shall be:

- a. in the slung position;
- b. held in an all-round grip in the left hand at the upper ring;

88. **La façon de prendre la position renversez armes en passant du pas ralenti au pas cadencé.**

Au commandement « CHANGEZ DE CADENCE, PAS CADENCÉ — MARCHÉ », ramener la main gauche sur le côté au premier pas cadencé du pied gauche et, en même temps, laisser tomber la poignée de telle sorte que le sabre se trouve en position horizontale.

89. Au commandement « CHANGEZ DE CADENCE, PAS RALENTI — MARCHÉ », reprendre la position renversez armes au moment où le pied gauche touche le sol pour le premier pas ralenti.

90. **Façon de changer le sabre de côté en position renversez armes.** (Les mouvements sont coordonnés avec ceux des militaires portant le fusil ou la carabine.) Au commandement « CHANGEZ ARMES — UN », ramener la main gauche sur le côté et, en même temps, modifier la prise de la main droite en plaçant la main sous la fusée, le pouce vers la droite.

91. Au commandement « ESCOUADE — DEUX », rabaisser la pointe de manière à ce que le sabre se trouve à la verticale et passer le sabre de la main droite à la main gauche.

92. Au commandement « ESCOUADE — TROIS », ramener la main droite sur le côté.

93. Au commandement « ESCOUADE — QUATRE », pousser le sabre sous l'aisselle gauche.

94. Au commandement « ESCOUADE — CINQ », saisir la lame de la main droite derrière le dos, le dos de la main vers le bas. Le sabre forme alors un angle de 45 degrés. Modifier, en même temps, la position de la main gauche sur la poignée : tenir les doigts ensemble à gauche, le pouce à droite et le dos de la main dirigé vers la gauche.

95. Pour changer à nouveau le sabre de côté, procéder à l'inverse.

POSITION ASSISE

96. La position assise (figure 6-1-12) avec le sabre se décrit comme suit :

- a. le sabre est suspendu;
- b. l'officier tient le sabre en l'entourant complètement de la main gauche à la hauteur de l'anneau supérieur;

- c. held vertically with the shoe of the scabbard on the ground; and
- d. the guard to the front.

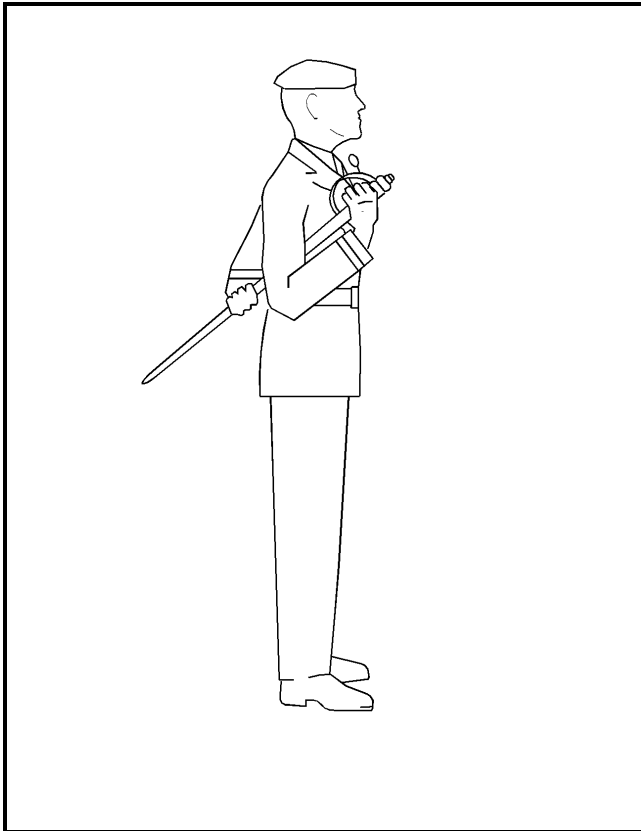

Figure 6-1-11 Reverse Arms
Figure 6-1-11 Position renversez armes

- c. l'officier tient le fourreau à la verticale, le dard au sol; et
- d. la garde est dirigée vers l'avant.

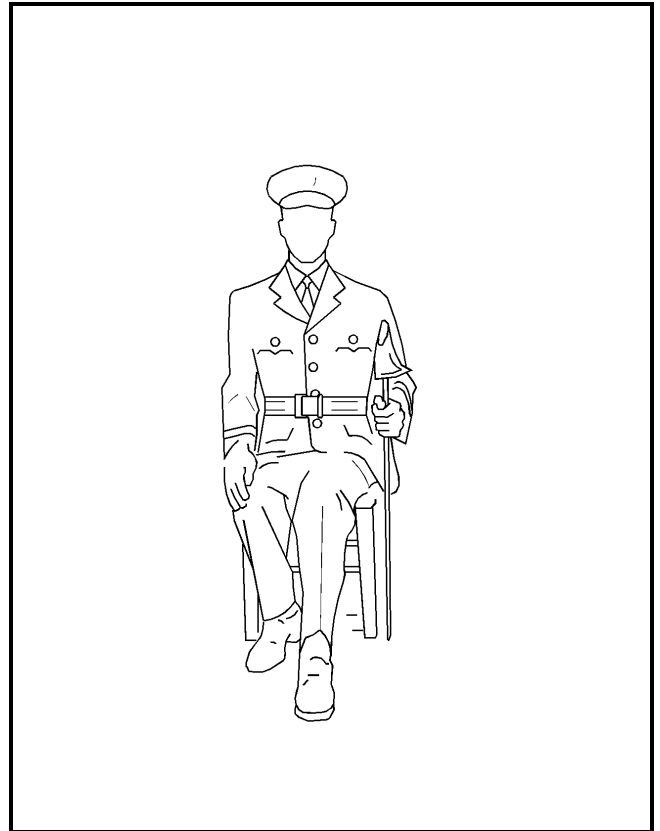

Figure 6-1-12 Position when Seated
Figure 6-1-12 Position assise

SECTION 2**PACE STICK AND CANE DRILL****THE PACE STICK**

1. The pace stick (Figure 6-2-1) is a training instrument used to gauge the length of pace and measure distance and interval. It may be used by warrant officers and non-commissioned officers which are proficient at drill. This section is included as a guide to assist instructors in the use of the pace stick.

2. The pace stick may be carried closed or open. The open position is the operating position.

3. The pace stick is a demanding instrument and requires constant practice. The instructor should march beside the leading squad member with the stick open and turning to control pace length over a sufficient distance to instill a feel for the correct pace in the personnel under training. When the squad has learned to march correctly, the instructor should periodically check pace length by marching behind the squad with the stick open and turning.

THE CANE

4. The cane is an optional accoutrement derived from riding crops, fashionable canes, etc., and still customarily used by some units (see A-AD-265-000/AG-001, CF Dress Instructions, Chapter 3). Cane drill is identical to drill with the closed pace stick.

DRILL ON THE MARCH

5. The executive order for stick drill on the march shall be given as the left foot is forward and on the ground, and movements are executed in a normal manner on subsequent paces by the left foot.

SECTION 2**MOUVEMENTS AVEC
LE MESURE-PAS ET AVEC LA CANNE****LE MESURE-PAS**

1. Le mesure-pas (figure 6-2-1) est un instrument de formation qui sert à mesurer la longueur des pas, les distances et les intervalles. Il peut être utilisé par les adjudants et les sous-officiers compétents en matière d'exercice. Cette section servira de guide pour aider les instructeurs à utiliser le mesure-pas.

2. Le mesure-pas se porte ouvert ou fermé. Lorsqu'on doit s'en servir, il se porte ouvert.

3. L'utilisation du mesure-pas est une fonction exigeante à laquelle il faut constamment s'exercer. À l'entraînement de l'escouade, l'instructeur marche à côté du militaire qui ouvre la marche en faisant pivoter son mesure-pas ouvert pour vérifier la longueur des pas. Il mesure ainsi les pas sur une distance suffisante pour habituer le groupe à la longueur de pas appropriée. Une fois que l'escouade a appris à marcher correctement, l'instructeur vérifie périodiquement la longueur des pas en suivant le groupe avec son mesure-pas ouvert et en le tournant.

LA CANNE

4. La canne est un accessoire facultatif qui a pour origine, entre autres, la cravache et la canne élégante et que certaines unités ont encore coutume d'utiliser (voir l'A-AD-265-000/AG-001, Instructions sur la tenue des FC, chapitre 3). Les mouvements avec la canne sont les mêmes que les mouvements exécutés avec le mesure-pas fermé.

MOUVEMENTS EN MARCHANT

5. Pour les mouvements à exécuter en marchant avec le mesure-pas, le commandement d'exécution est donné au moment où le pied gauche est en avant et au sol. Les différents mouvements sont exécutés successivement à chaque pas du pied gauche.

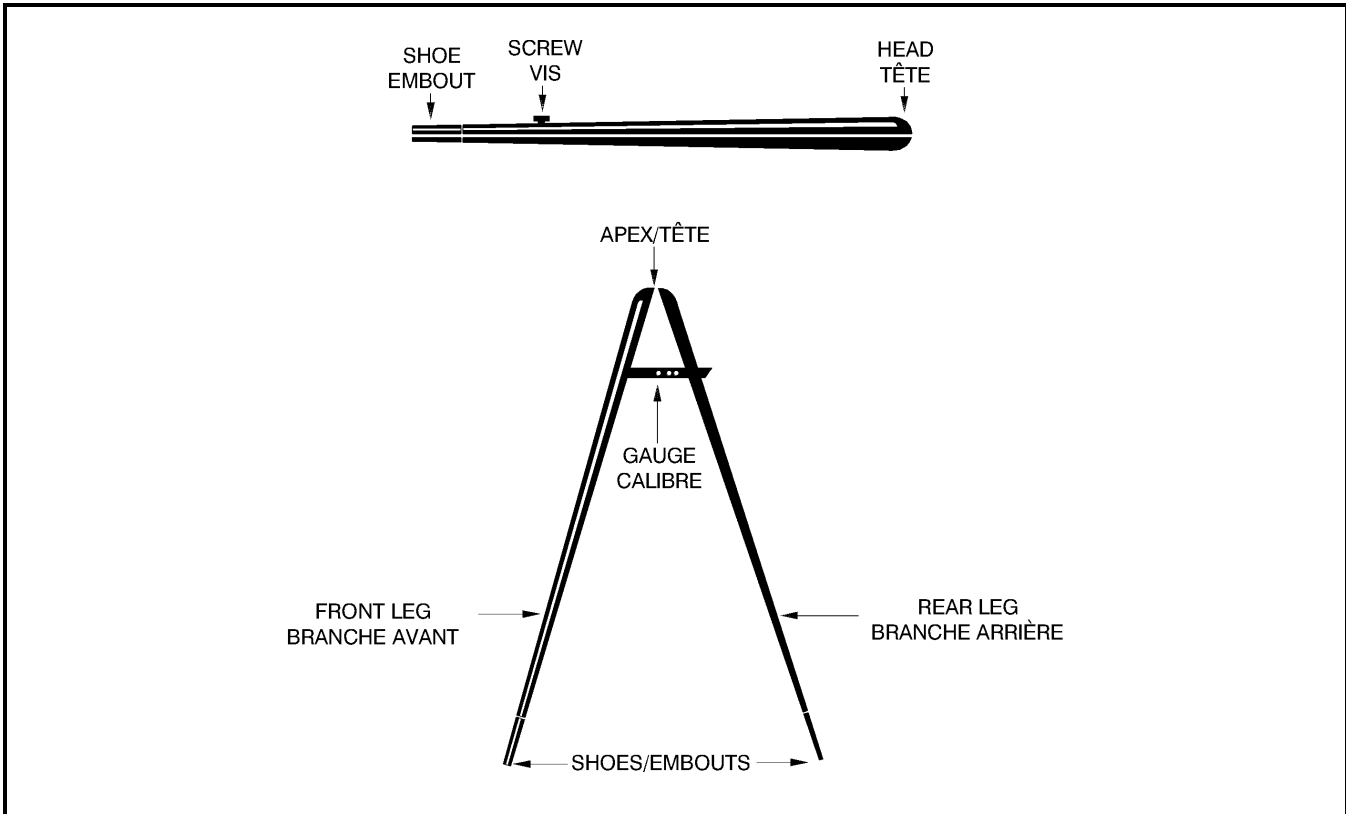

Figure 6-2-1 Pace Stick
Figure 6-2-1 Mesure-pas

CLOSED: ATTENTION OR CARRY POSITION

MESURE-PAS FERMÉ – POSITION DU GARDE-À-VOUS OU AU PORT

6. To assume the position of attention (Figure 6-2-2):

6. Pour adopter la position du garde-à-vous (figure 6-2-2) :

- a. the pace stick is held under the left armpit by pressure of the upper arm and rib cage, at the point of balance, parallel to the ground;
- b. the shoes to the rear;
- c. the retaining screw uppermost;
- d. the head of the stick between the thumb and forefinger of the left hand, the fingers extended with the index finger running parallel with the stick and tip of the middle finger in line with the head end of the stick; and
- e. the right arm is kept straight at the side.

- a. tenir le mesure-pas sous l'aisselle gauche, au point d'équilibre, serré entre la cage thoracique et le haut du bras et parallèle au sol;
- b. diriger les embouts vers l'arrière;
- c. placer la vis de retenue vers le haut;
- d. tenir la tête du mesure-pas entre le pouce et l'index de la main gauche, en gardant les doigts étendus et en ligne avec la main, l'index parallèle au mesure-pas et l'extrémité du majeur aligné sur la tête du mesure-pas; et
- e. garder le bras droit bien droit sur le côté.

7. The stick may be held in the carry position on the march; the right arm shall be swung.

8. When speaking to an officer, the stick is held in this position to permit saluting.

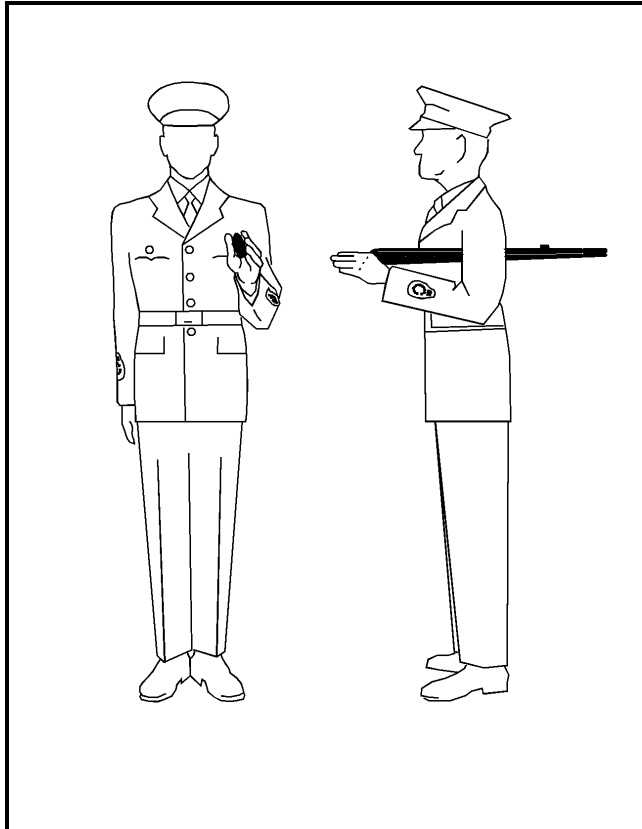

Figure 6-2-2 Attention or Carry Position
Figure 6-2-2 Position du garde-à-vous ou au port

CLOSED: STAND AT EASE

9. On the command STAND AT – EASE:
- a. carry the left foot normally to the left (Figure 6-2-3); and
 - b. keep the right arm straight at the side.

CLOSED: STAND EASY

10. On the command STAND – EASY, relax the body.

7. En marchant, on peut tenir le mesure-pas en position au port. On balance alors le bras droit de la façon normale.

8. La position au port est la position à adopter lorsqu'on s'adresse à un officier parce qu'elle permet de saluer.

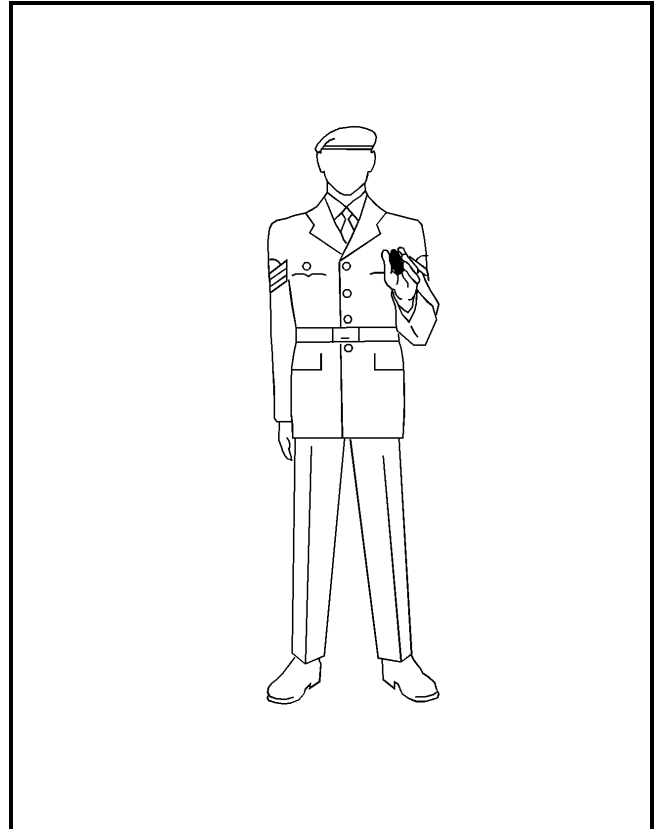

Figure 6-2-3 Stand at Ease at the Carry
Figure 6-2-3 Position en place repos, le mesure-pas au port

MESURE-PAS FERMÉ – POSITION EN PLACE REPOS

9. Au commandement « EN PLACE, RE — POS » :
- a. déplacer le pied gauche à la distance normale vers la gauche (figure 6-2-3); et
 - b. garder le bras droit bien droit sur le côté.

MESURE-PAS FERMÉ – POSITION REPOS

10. Au commandement « RE — POS », détendre le corps.

CLOSED: ATTENTION AT THE SHOULDER

11. When space is restricted, such as in a hallway, the closed pace stick may be held at the shoulder rather than under the arm.

12. The pace stick is held in the right hand in a near-vertical position with the brass shoes uppermost and the retaining screw to the front (Figure 6-2-4). The stick is placed on the second joint of the forefinger, with the remaining fingers gripping the side of the stick and the thumb along the stick's front. The thumb is in line with the trouser seam.

13. The stick is moved from the carry position to the shoulder in two movements by grasping the head with the right hand while simultaneously cutting the left arm to the side, and then whipping the right hand to the shoulder position. The drill is reversed to move from the shoulder to the carry.

14. The stick is carried while marching in this position in restricted spaces and both arms are swung.

15. If the stick is to be held at the trail when stepping off from this position, the movements are as for the trail arms from the shoulder with a rifle (Chapter 4). If the stick is to be placed into this position after halting at the trail, it is moved to the shoulder in two movements as follows:

- a. flick it up vertically, rotating the stick so that the retaining screw is forward, catching it simultaneously with the left hand, forearm parallel, and the right hand, at the head of the stick, the latter held tight into the shoulder; and
- b. after a standard pause, cut the left hand to the side.

CLOSED: STAND AT EASE AT THE SHOULDER

16. On the command STAND AT – EASE:

- a. carry the left foot normally to the left (Figure 6-2-4); and

MESURE-PAS FERMÉ – POSITION DU GARDE-À-VOUS LE MESURE-PAS À L'ÉPAULE

11. Dans un espace restreint, comme un vestibule par exemple, on peut tenir le mesure-pas fermé à l'épaule plutôt que sous le bras.

12. Tenir le mesure-pas de la main droite, presque à la verticale, les embouts vers le haut et la vis de retenue vers l'avant (figure 6-2-4). Poser le mesure-pas contre la deuxième jointure de l'index, en gardant les autres doigts sur le côté et le pouce sur le devant, dans la ligne de la couture du pantalon.

13. Passer de la position au port à la position à l'épaule en deux mouvements : empoigner la tête du mesure-pas de la main droite tout en ramenant le bras gauche sur le côté, puis porter le mesure-pas à l'épaule, d'un geste vif de la main droite. Pour passer de la position à l'épaule à la position au port, procéder à l'inverse.

14. Cette position est adoptée pour la marche avec le mesure-pas dans des espaces restreints. Il y a alors balancement des deux bras.

15. Pour passer de la position à l'épaule à la position à la main au moment de se mettre à marcher, on exécute les mêmes mouvements que pour passer de la position à l'épaule armes à la position à la main armes avec le fusil (chapitre 4). Pour passer de la position à la main à cette position, à la halte, on exécute les deux mouvements suivants :

- a. donner un petit coup au mesure-pas vers le haut en le faisant pivoter pour que la vis fasse face à l'avant et le saisir en même temps à la verticale, de la main gauche, l'avant-bras parallèle au sol; saisir la tête du mesure-pas avec la main droite et tenir le mesure-pas serré contre l'épaule; et
- b. après la pause réglementaire, ramener la main gauche sur le côté.

MESURE-PAS FERMÉ – POSITION EN PLACE REPOS LE MESURE-PAS À L'ÉPAULE

16. Au commandement « EN PLACE, RE — POS » :

- a. déplacer le pied gauche à la distance normale vers la gauche (figure 6-2-4); et

- b. retaining the stick in the right hand, move the right hand behind the back into the palm of the left hand.

- b. tout en gardant le mesure-pas dans la main droite, passer la main droite derrière le dos et la placer contre la paume de la main gauche.

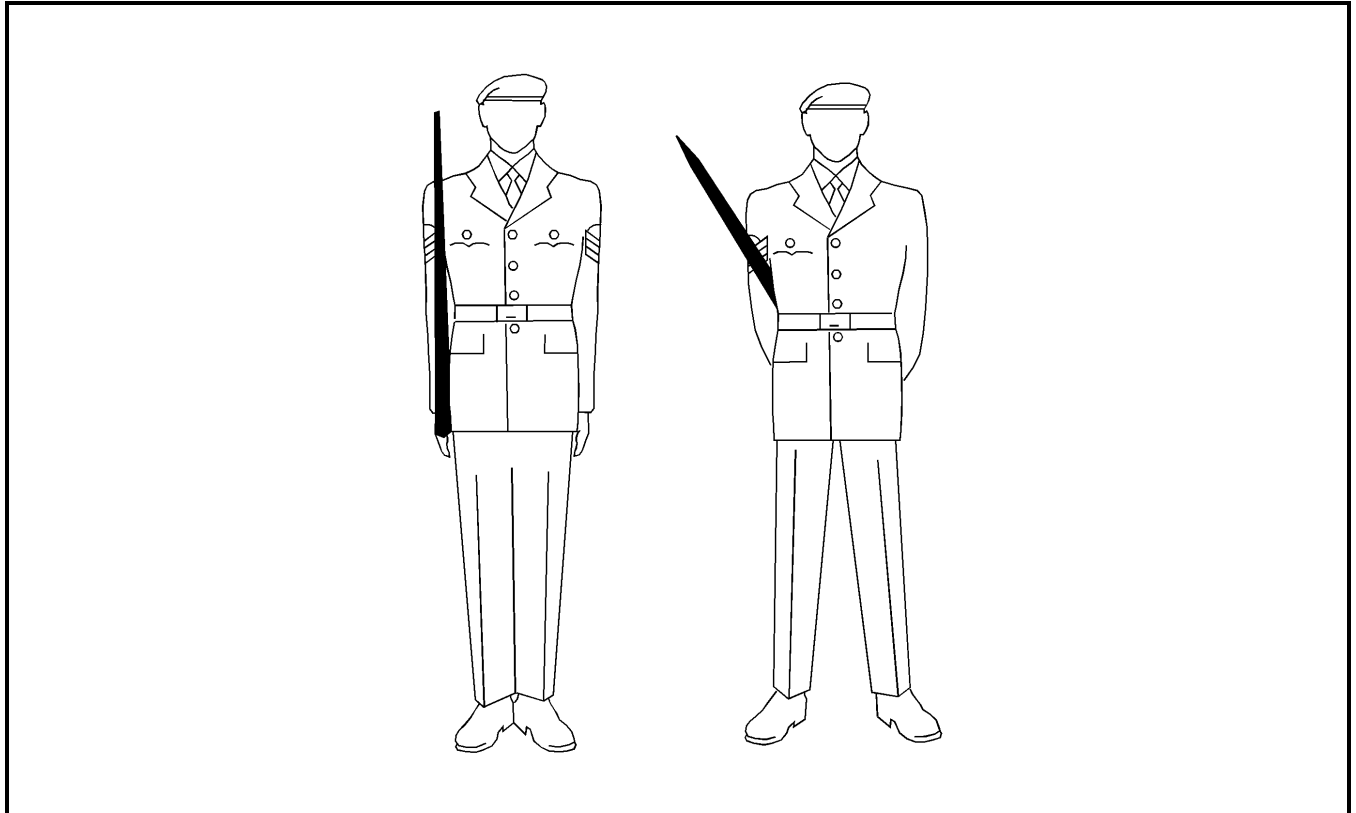

Figure 6-2-4 Stand at Ease at the Shoulder

Figure 6-2-4 Position en place repos le mesure-pas à l'épaule

CLOSED: STAND EASY AT THE SHOULDER

17. On the command STAND – EASY, relax the body.

CLOSED: TRAIL FROM THE CARRY AT THE HALT

18. On the command TRAIL STICKS BY NUMBERS, SQUAD – ONE, move the stick forward slightly with the left hand, and simultaneously grasp the stick with the right hand in an all-round grip at the point of balance, the back of the hand uppermost.

MESURE-PAS FERMÉ – POSITION REPOS LE MESURE-PAS À L'ÉPAULE

17. Au commandement « RE — POS », détendre le corps.

MESURE-PAS FERMÉ – DE LA POSITION AU PORT À LA POSITION À LA HALTE

18. Au commandement « EN DÉCOMPOSANT, MESURE-PAS À LA MAIN, ESCOUADE — UN », déplacer légèrement le mesure-pas vers l'avant avec la main gauche et, en même temps, empoigner le mesure-pas de la main droite, à son centre de gravité, en gardant le dos de la main vers le haut.

19. On the command SQUAD – TWO, lower the pace stick to a horizontal position with shoes forward at the full extent of the right arm, while simultaneously cutting the left arm to the side.

20. On the command TRAIL – STICKS, the movements are combined.

CLOSED: TRAIL FROM THE CARRY ON THE MARCH

21. On the command TRAIL STICKS BY NUMBERS, SQUAD – ONE given as the left foot is forward and on the ground:

- a. complete a check pace with the right foot; and
- b. as the left foot next comes forward and strikes the ground (Figure 6-2-5), move the pace stick forward slightly with the left hand, and simultaneously grasp the stick with the right hand in an all-round grip at the point of balance, the back of the hand uppermost.

22. On the command SQUAD – TWO:

- a. complete a check pace with the right foot; and
- b. as the left foot next comes forward and strikes the ground, lower the pace stick to a horizontal position with shoes forward at the full extent of the right arm, while simultaneously cutting the left arm to the side.

23. On the command SQUAD – THREE, complete a check pace with the right foot and, as the left foot next comes forward and strikes the ground, commence swinging both arms.

24. On the command TRAIL – STICKS, the movements are combined.

25. When marching with the stick at the trail, the stick is carried at the point of balance, shoes to the front, retaining screw up, and is kept horizontal as the right arm is swung.

19. Au commandement « ESCOUADE — DEUX », abaisser le mesure-pas à la position horizontale en le tenant à pleine extension du bras droit, les embouts vers l'avant et, en même temps, ramener le bras gauche le long du corps.

20. Au commandement « MESURE-PAS À LA — MAIN », les mouvements sont combinés.

MESURE-PAS FERMÉ – DE LA POSITION AU PORT À LA POSITION À LA MAIN EN MARCHANT

21. Au commandement « EN DÉCOMPOSANT, MESURE-PAS À LA MAIN, ESCOUADE — UN », donné au moment où le pied gauche est en avant et au sol :

- a. faire un pas de transition du pied droit; et
- b. au moment où le pied gauche revient vers l'avant et touche le sol (figure 6-2-5), déplacer légèrement le mesure-pas vers l'avant avec la main gauche et, en même temps, empoigner le mesure-pas de la main droite, à son centre de gravité, en gardant le dos de la main vers le haut.

22. Au commandement « ESCOUADE — DEUX » :

- a. faire un pas de transition du pied droit; et
- b. au moment où le pied gauche revient vers l'avant et touche le sol, abaisser le mesure-pas à la position horizontale en le tenant à pleine extension du bras droit, les embouts vers l'avant et, en même temps, ramener le bras gauche le long du corps.

23. Au commandement « ESCOUADE — TROIS », faire un pas de transition du pied droit et, au moment où le pied gauche revient vers l'avant et touche le sol, commencer à balancer les deux bras.

24. Au commandement « MESURE-PAS À LA — MAIN », les mouvements sont combinés.

25. En marche, lorsque le mesure-pas est tenu à la main, on le tient à son point d'équilibre, les embouts dirigés vers l'avant, la vis de retenue vers le haut, et on le maintient à l'horizontale en balançant le bras droit.

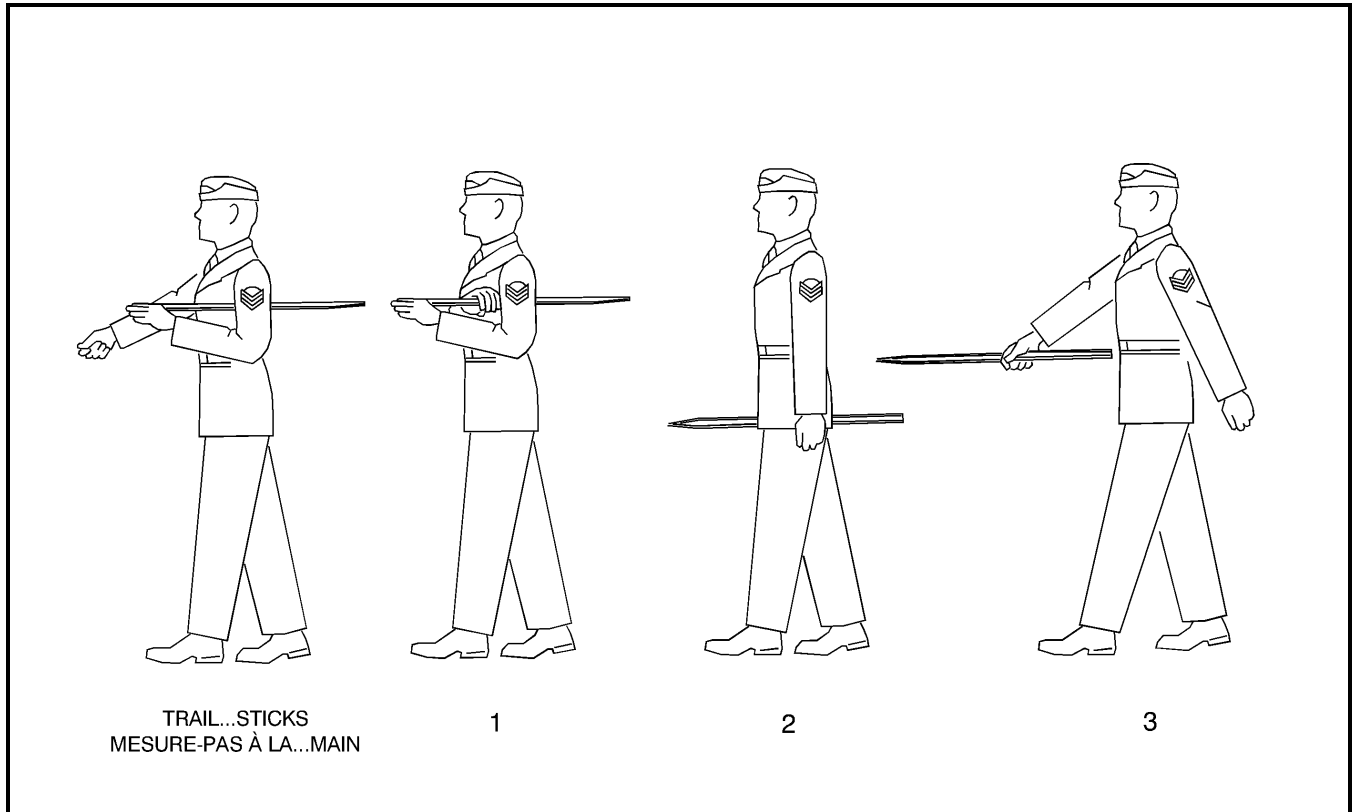

Figure 6-2-5 Trail from the Carry Position

Figure 6-2-5 Façon de passer de la position au port à la position à la main

CLOSED: CARRY FROM THE TRAIL AT THE HALT

26. On the command CARRY STICKS BY NUMBERS, SQUAD – ONE:

- a. with the right hand force the pace stick under the left arm; and
- b. simultaneously, grasp the head with the left hand in the carry position.

27. On the command SQUAD – TWO, cut the right hand to the side and move the pace stick back 5 cm.

28. On the command CARRY – STICKS, the two movements are combined. A standard pause shall be observed between the movements.

MESURE-PAS FERMÉ – DE LA POSITION À LA MAIN À LA POSITION AU PORT À LA HALTE

26. Au commandement « EN DÉCOMPOSANT, MESURE-PAS AU PORT, ESCOUADE — UN » :

- a. pousser le mesure-pas sous le bras gauche avec la main droite; et
- b. en même temps, saisir la tête du mesure-pas avec la main gauche, dans la position au port.

27. Au commandement « ESCOUADE — DEUX », ramener la main droite sur le côté et déplacer le mesure-pas de 5 cm vers l'arrière.

28. Au commandement « MESURE-PAS AU — PORT », les deux mouvements sont combinés et on observe la pause réglementaire entre les mouvements.

CLOSED: CARRY FROM THE TRAIL ON THE MARCH

29. On the command CARRY STICKS BY NUMBERS, SQUAD – ONE given as the left foot is forward and on the ground:

- a. complete a check pace with the right foot,
- b. as the left foot next comes forward and strikes the ground, with the right hand force the pace stick under the left arm; and
- c. simultaneously, grasp the head with the left hand in the carry position.

30. On the command SQUAD – TWO:

- a. complete a check pace with the right foot; and
- b. cut the right hand to the side and move the pace stick back 5 cm.

31. On the command SQUAD – THREE:

- a. complete a check pace with the right foot; and
- b. swing the right arm.

32. On the command CARRY – STICKS, the three movements are combined.

CLOSED: HALTING

33. When halting, the pace stick is moved from the trail to the carry on completion of the halt and after the observance of a standard pause.

34. The stick is returned to the carry prior to saluting and may be returned to the carry anytime at the discretion of the instructor.

CLOSED: SALUTING

35. When saluting with the pace stick in the carry position, the right hand comes up to the salute normally. The left hand retains its grip on the head of the stick throughout (Figure 6-2-6).

MESURE-PAS FERMÉ – DE LA POSITION À LA MAIN À LA POSITION AU PORT EN MARCHANT

29. Au commandement « EN DÉCOMPOSANT, MESURE-PAS AU PORT, ESCOUADE — UN », donné au moment où le pied gauche est en avant et au sol :

- a. faire un pas de transition du pied droit;
- b. au moment où le pied gauche revient vers l'avant et touche le sol, pousser le mesure-pas sous le bras gauche avec la main droite; et
- c. en même temps, saisir la tête du mesure-pas avec la main gauche, dans la position au port.

30. Au commandement « ESCOUADE — DEUX » :

- a. faire un pas de transition du pied droit; et
- b. ramener la main droite sur le côté et déplacer le mesure-pas de 5 cm vers l'arrière.

31. Au commandement « ESCOUADE — TROIS » :

- a. faire un pas de transition du pied droit; et
- b. balancer le bras droit.

32. Au commandement « MESURE-PAS AU PORT », les trois mouvements sont combinés.

MESURE-PAS FERMÉ – FAÇON DE S'ARRÊTER

33. En faisant halte, passer de la position à la main à la position au port une fois arrêté et après observation de la pause réglementaire.

34. Avant de saluer, il faut reprendre la position au port. On peut aussi reprendre cette position en tout temps, selon les indications de l'instructeur.

MESURE-PAS FERMÉ – SALUT

35. À la position au port, on salue de la main droite de la façon normale. Pendant ce temps, on tient la tête du mesure-pas de la main gauche (figure 6-2-6).

OPEN: ATTENTION

36. To assume the position of attention:
- with the right hand, grasp the rear leg of the pace stick 2 cm below the apex, with the forefinger hooked around the front leg (Figure 6-2-7);
 - hold the front leg vertical and rest it on the ground in line with and 2 cm to the right of the toe of the boot;
 - keep the rear leg off the ground and pointed directly to the rear; and
 - keep the elbows close to the side.

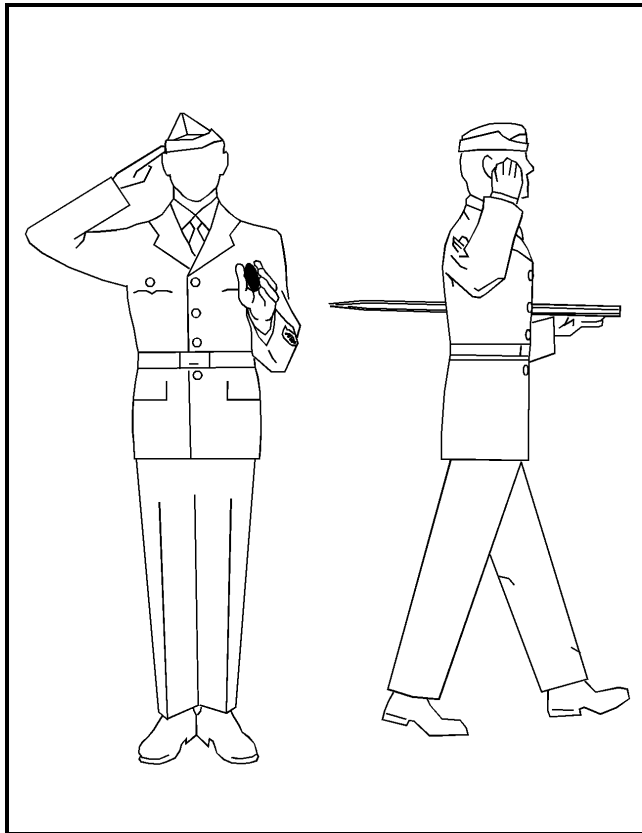

Figure 6-2-6 Salute at the Carry
Figure 6-2-6 Salut, mesure-pas au port

MESURE-PAS OUVERT – POSITION DU GARDE-À-VOUS

36. Pour adopter la position du garde-à-vous :
- saisir la branche arrière du mesure-pas de la main droite, 2 cm au-dessous de la tête, la branche avant étant retenue par l'index (figure 6-2-7);
 - tenir la branche avant à la verticale et la poser sur le sol, alignée sur le bout de la chaussure et à 2 cm à sa droite;
 - garder la branche arrière à distance du sol et la pointer directement vers l'arrière; et
 - garder les coudes serrés contre le corps.

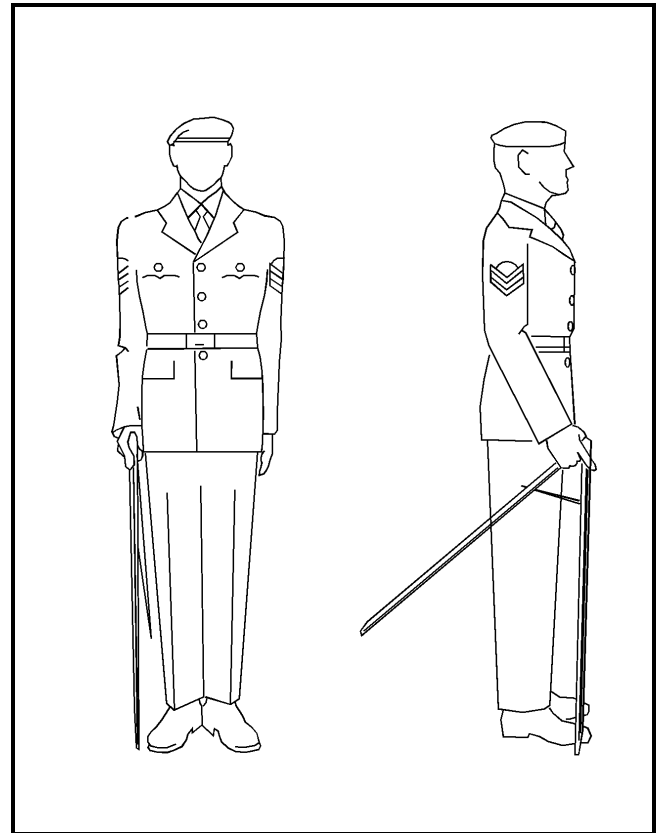

Figure 6-2-7 Attention, Pace Stick Open
Figure 6-2-7 Position du garde-à-vous, mesure-pas ouvert

OPEN: STAND AT EASE

37. On the command STAND AT – EASE:
- a. carry the left foot normally to the left (Figure 6-2-8); and
 - b. keep the arms at the side.

OPEN: STAND EASY

38. On the command STAND – EASY, relax the body.

OPEN: MARCHING AND HALTING NOT PACING

39. On the command QUICK (SLOW) – MARCH, step off with the left foot and bring the right forearm parallel to the ground, the index finger in front of the front leg and the remaining fingers curled around the rear leg, and the front leg of the stick kept vertical. The right elbow is held into the side (Figure 6-2-9).

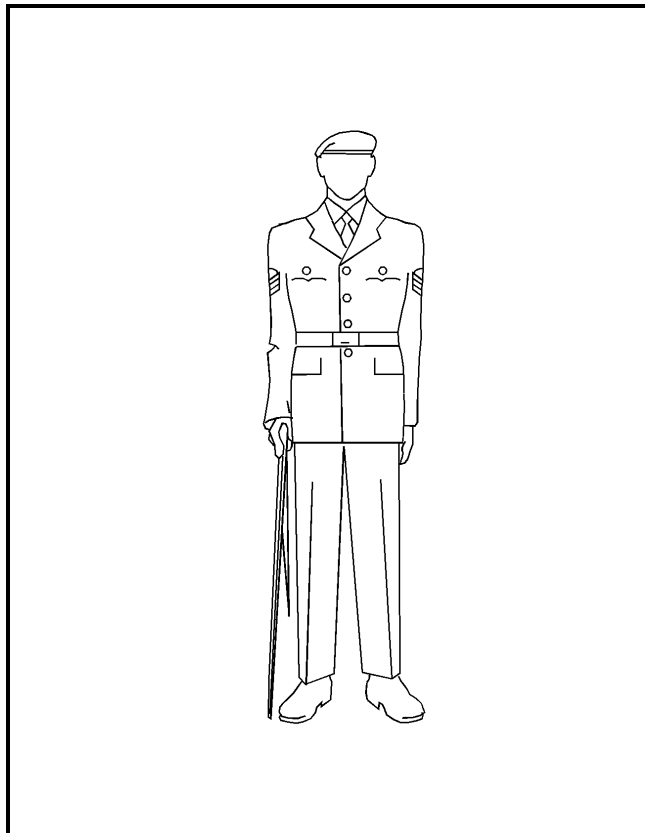

Figure 6-2-8 Stand at Ease
Figure 6-2-8 Position en place repos

MESURE-PAS OUVERT – POSITION EN PLACE REPOS

37. Au commandement « EN PLACE, RE — POS » :
- a. déplacer le pied gauche à la distance normale vers la gauche (figure 6-2-8); et
 - b. garder les bras immobiles le long du corps.

MESURE-PAS OUVERT – POSITION REPOS

38. Au commandement « RE — POS », détendre le corps.

MESURE-PAS OUVERT – FAÇON DE MARCHER ET DE S'ARRÊTER SANS MESURER LE PAS

39. Au commandement « PAS CADENCÉ (RALENTI) — MARCHÉ », partir du pied gauche, l'avant-bras droit parallèle au sol, l'index devant la branche avant et les autres doigts entourant la branche arrière. Maintenir la branche avant du mesure-pas à la verticale et tenir le coude droit près du corps (figure 6-2-9).

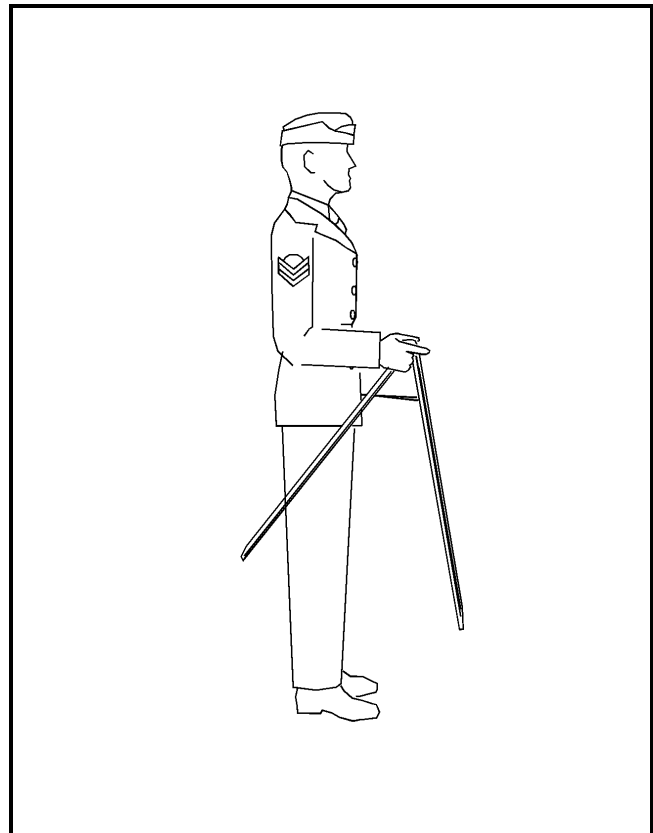

Figure 6-2-9 Marching and Halting, not Pacing
Figure 6-2-9 Façon de marcher et de s'arrêter sans mesurer le pas

40. This position is also called the carry when the pace stick is open.

41. On the command SQUAD – HALT, the halt is executed normally. After a standard pause, the stick is lowered to the position of attention.

OPEN: PACING

42. On the command QUICK (SLOW) – MARCH, step off with the left foot, and simultaneously swing the rear leg of the stick forward by twisting with the fingers and thumb and rotating the free leg of the stick outwards and forward (Figure 6-2-10). Place the swinging shoe on the ground straight in front of the point already on the ground in time with the pace.

43. Continue turning the stick until the correct pace is well established, until halted, or until ordered back to the carry position for open pace stick.

44. The stick is controlled by the fingers, good wrist movement, the thumb and pressure on the leading leg. It is essential to keep the leading leg perpendicular as the stick swings through 180 degrees with ease.

45. New instructors should practice first in slow time. It is easier to master the technique by practising on grass first, then move to the parade ground.

40. On appelle également cette position la position au port avec le mesure-pas ouvert.

41. Au commandement « ESCOUADE — HALTE », faire halte de la façon normale. Après la pause réglementaire, abaisser le mesure-pas pour prendre la position du garde-à-vous.

MESURE-PAS OUVERT – FAÇON DE MESURER LE PAS

42. Au commandement « PAS CADENCÉ (RALENTI) — MARCHÉ », partir du pied gauche et, avec le pouce et les doigts, faire pivoter vers l'avant et par l'extérieur la branche arrière du mesure-pas (figure 6-2-10). L'embout de la branche qui pivote doit être ramené droit devant l'autre au rythme de la démarche.

43. Continuer à faire pivoter le mesure-pas jusqu'à ce que l'escouade ait bien réglé la longueur de ses pas ou qu'elle s'arrête ou jusqu'à ce que soit donné l'ordre de reprendre la position au port avec le mesure-pas ouvert.

44. Pour bien manipuler le mesure-pas, il faut avoir acquis l'habileté nécessaire des doigts, du pouce et du poignet et savoir exercer la pression voulue sur la branche avant. Il est important de maintenir la branche au sol à la verticale pendant que le mesure-pas pivote sur 180 degrés.

45. Les nouveaux instructeurs devraient commencer par s'exercer au pas ralenti. Il est plus facile de s'entraîner d'abord sur du gazon avant d'utiliser le mesure-pas sur le terrain d'exercice.

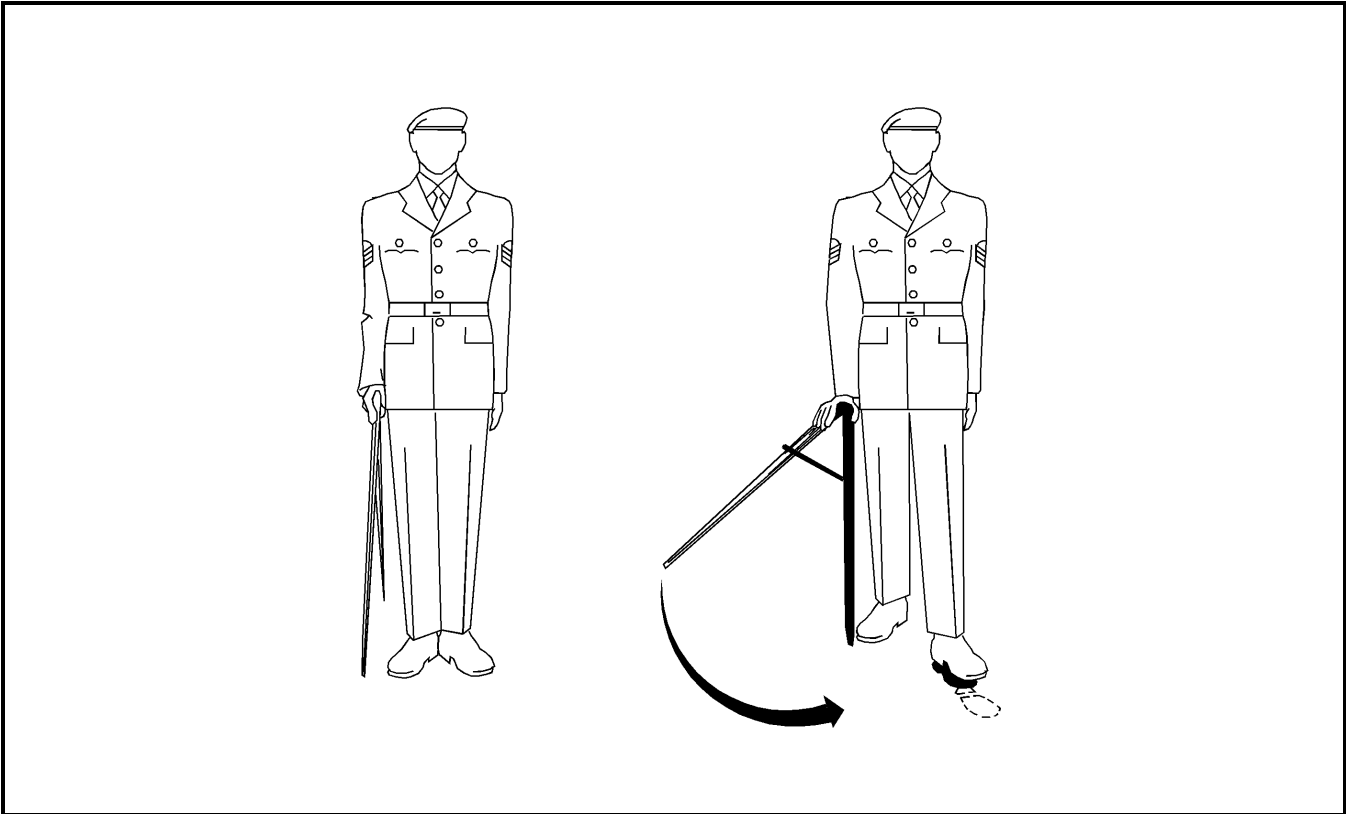

Figure 6-2-10 Pacing
Figure 6-2-10 Façon de mesurer le pas

OPEN: SALUTING

46. On the command SALUTING TO THE FRONT BY NUMBERS, SQUAD – ONE, adopt the carry position as for pace stick open (Figure 6-2-11).

47. On command SQUAD – TWO:

- a. with the right hand, move the pace stick to a position 10 cm in front of the centre of the body, keeping the forearm parallel to the ground; and
- b. simultaneously, grasp the front leg of the stick 2 cm below the apex with the left hand, the forefinger over the knuckles of the right hand.

48. On the command SQUAD – THREE:

- a. release the right hand and bring the right arm to the side; and

MESURE-PAS OUVERT – FAÇON DE SALUER

46. Au commandement « EN DÉCOMPOSANT, SALUT VERS L'AVANT, ESCOUADE — UN », adopter la position au port, le mesure-pas ouvert (figure 6-2-11).

47. Au commandement « ESCOUADE — DEUX » :

- a. amener le mesure-pas avec la main droite à 10 cm en avant et au centre du corps, tout en gardant l'avant-bras parallèle au sol; et
- b. en même temps, saisir la branche avant avec la main gauche, 2 cm au-dessous de la tête du mesure-pas, l'index couvrant les jointures de la main droite.

48. Au commandement « ESCOUADE — TROIS » :

- a. desserrer la main droite et ramener le bras droit le long du corps; et

- b. simultaneously, move the left arm so the forearm is parallel to the ground, the rear leg of the pace stick vertical and the front leg pointing to the rear.

- b. en même temps, déplacer le bras gauche en maintenant l'avant-bras parallèle au sol, la branche arrière du mesure-pas à la verticale et la branche avant pointant vers l'arrière.

49. On the command SQUAD – FOUR, salute with the right hand.

49. Au commandement « ESCOUADE — QUATRE », saluer de la main droite.

50. On the command SQUAD – FIVE, cut the right arm to the side.

50. Au commandement « ESCOUADE — CINQ » ramener le bras droit le long du corps.

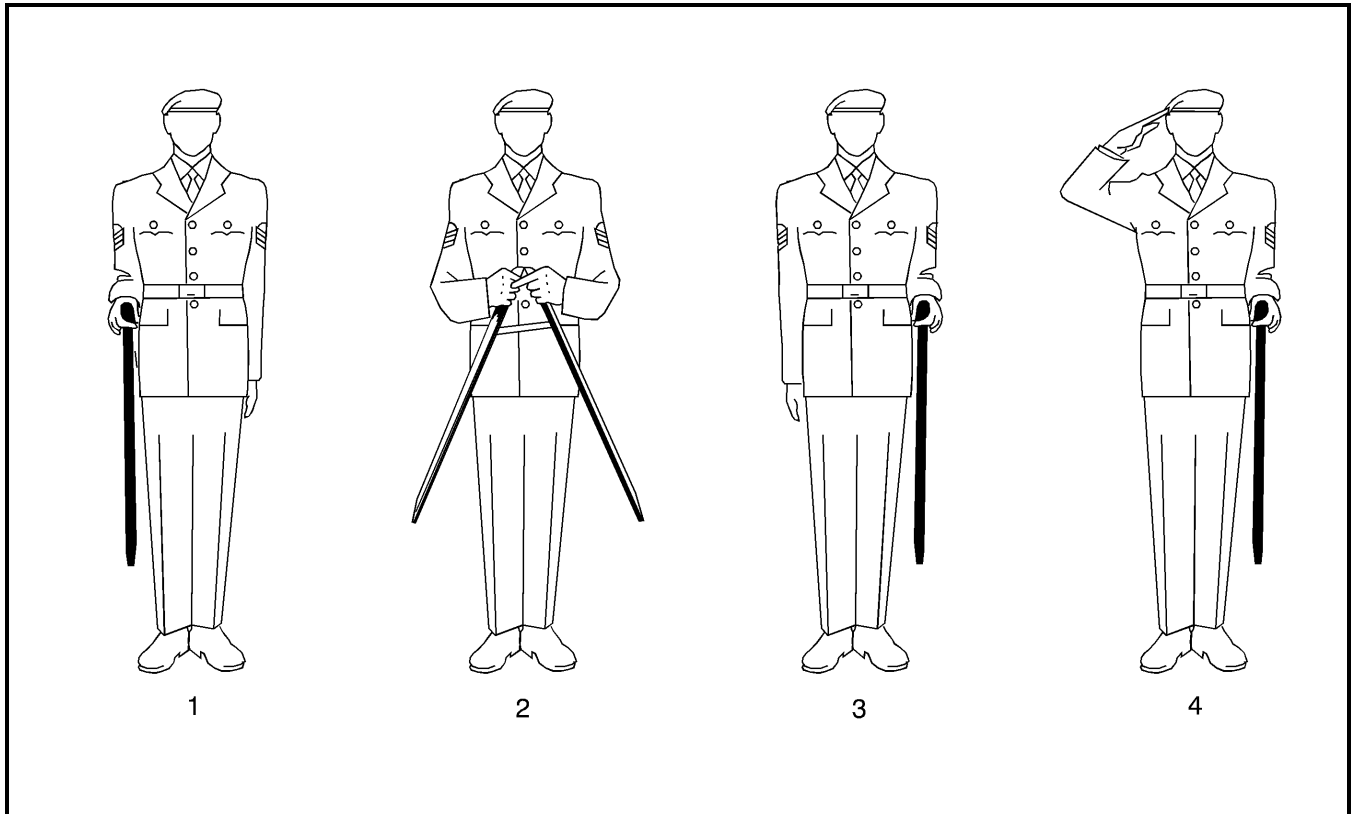

Figure 6-2-11 Saluting, Pace Stick Open
 Figure 6-2-11 Salut, mesure-pas ouvert

51. On the command SQUAD – SIX:
- a. with the left hand, move the stick back to a position 10 cm in front and centre of the body keeping the forearms parallel to the ground; and
 - b. simultaneously, with the right hand, grasp the rear leg of the stick 2 cm below the apex with the right hand, the forefinger over the knuckles of the left hand.

51. Au commandement « ESCOUADE — SIX » :
- a. ramener le mesure-pas avec la main gauche à 10 cm en avant et au centre du corps en gardant les avant-bras parallèles au sol; et
 - b. en même temps, saisir la branche arrière de la main droite, à 2 cm au dessous de la tête du mesure-pas, en plaçant l'index sur les jointures de la main gauche.

52. On the command SQUAD – SEVEN:

- a. release the left hand and bring the left arm to the side; and
- b. simultaneously, move the right arm so the forearm is parallel to the ground, with the front leg of the pace stick vertical and the rear leg pointing to the rear.

53. On the command SQUAD – EIGHT, assume the position of attention.

54. On the command TO THE FRONT, SA – LUTE, the eight movements are combined. A standard pause shall be observed between the movements.

55. While marching in slow or quick time, all movements are executed on successive left feet.

52. Au commandement « ESCOUADE — SEPT » :

- a. desserrer la main gauche et ramener le bras gauche le long du corps; et
- b. en même temps, déplacer le bras droit en gardant l'avant-bras parallèle au sol, la branche avant du mesure-pas à la verticale et la branche arrière pointant vers l'arrière.

53. Au commandement « ESCOUADE — HUIT », adopter la position du garde-à-vous.

54. Au commandement « SALUT VERS L'AVANT, SALU — EZ », combiner les huit mouvements et observer une pause réglementaire entre les mouvements.

55. Pour la marche au pas ralenti ou cadencé, exécuter tous les mouvements successivement chaque fois que le pied gauche touche le sol.

CHAPTER 7
PLATOON, COMPANY AND BATTALION DRILL

SECTION 1

INTRODUCTION

GENERAL

1. Once service personnel have learned individual and squad drill as described in previous chapters, they can function effectively as part of a formed unit on parade.
2. The drill detailed in this chapter allows units to manoeuvre as one in order to carry out any routine or ceremonial task. It is derived from the marching and battle drills formerly used in combat. Thus:
 - a. Units in line once presented their maximum frontage and brought all weapons to bear. Now they use line to show themselves to best advantage to reviewing officers and spectators. It is the most difficult formation to control on the march and units still demonstrate their high standards of drill and training by manoeuvring and marching past with sub-units in line.
 - b. Troops in column reduced their frontage for ease of control or to pass through defiles and along roads.
 - c. Manoeuvres such as changing direction by form and forming platoons (companies) allowed units and sub-units to change their formation in order to present their maximum frontage toward the designated directions.
 - d. The use of advance and retire in line and the positions maintained by officers and non-commissioned officers relative to the ranks ensured that all were aware of the important direction being faced by the sub-unit concerned.
3. As in the past, commanders order the movements their unit is to perform, and non-commissioned officers assist in control. Thus the former take post before their troops, and the latter on the flanks and in the rear. During dressing, non-commissioned officers control the exactness of the drill.

PLATOON DRILL

4. The aim of platoon drill is to enable the platoon, when it takes its place in the company, to carry out any sequence of drill movements which the company commander orders.

COMPANY DRILL

5. The aim of company drill is to manoeuvre the company together as one.

BATTALION DRILL

6. The aim of battalion drill is to manoeuvre the battalion together as one unit.

FORMATION DRILL

7. Larger formations, such as brigades, can manoeuvre together by applying the principles of battalion drill. Thus a brigade can parade with its component units in line, in column (or close column) of battalions, etc. Because of space limitations, formations most commonly parade in mass, that is with its component battalions in line, each battalion being in close column of companies.

8. Control is difficult in large formations. Words of command are most often executed in succession by battalions or on an executive command sounded by trumpet or bugle.

9. Since parade commanders order formation manoeuvres and ceremonial based on an extension of the principles discussed in this chapter, formation drill is not otherwise described in this manual.

SECTION 2

PLATOON DRILL

INTRODUCTION

1. Although the words of commands and detail in this section specifically refer to movements executed in quick time, platoon drill may also be executed in slow and double time.
2. Movements will be executed using either flank as the directing flank except during a wheel when dressing is taken from the inner flank.
3. Details for exercising a squad with and without arms contained in previous chapters are applicable to platoon drill.
4. When changing positions during platoon drill at the halt or on the march in slow time, persons in appointed positions and supernumerary ranks will move in quick time. While marching in quick time, changes will be made in double time.
5. When on parade with arms, the platoon warrant officer may hand the platoon over to the platoon commander with the platoon at the shoulder arms or order arms positions. However, he shall adopt the shoulder arms positions himself. Similarly, whenever the platoon warrant officer is giving orders to the platoon and he is carrying arms, he shall adopt the shoulder arms position.
6. When on parade with arms, it is normal to shoulder arms before moving off.

PLATOON IN LINE

7. Regardless of its frontage, when a platoon is formed up in line, the platoon commander shall position himself three paces in front and centre of the platoon and the platoon warrant officer three paces in rear and centre of the platoon (Figure 7-2-1).

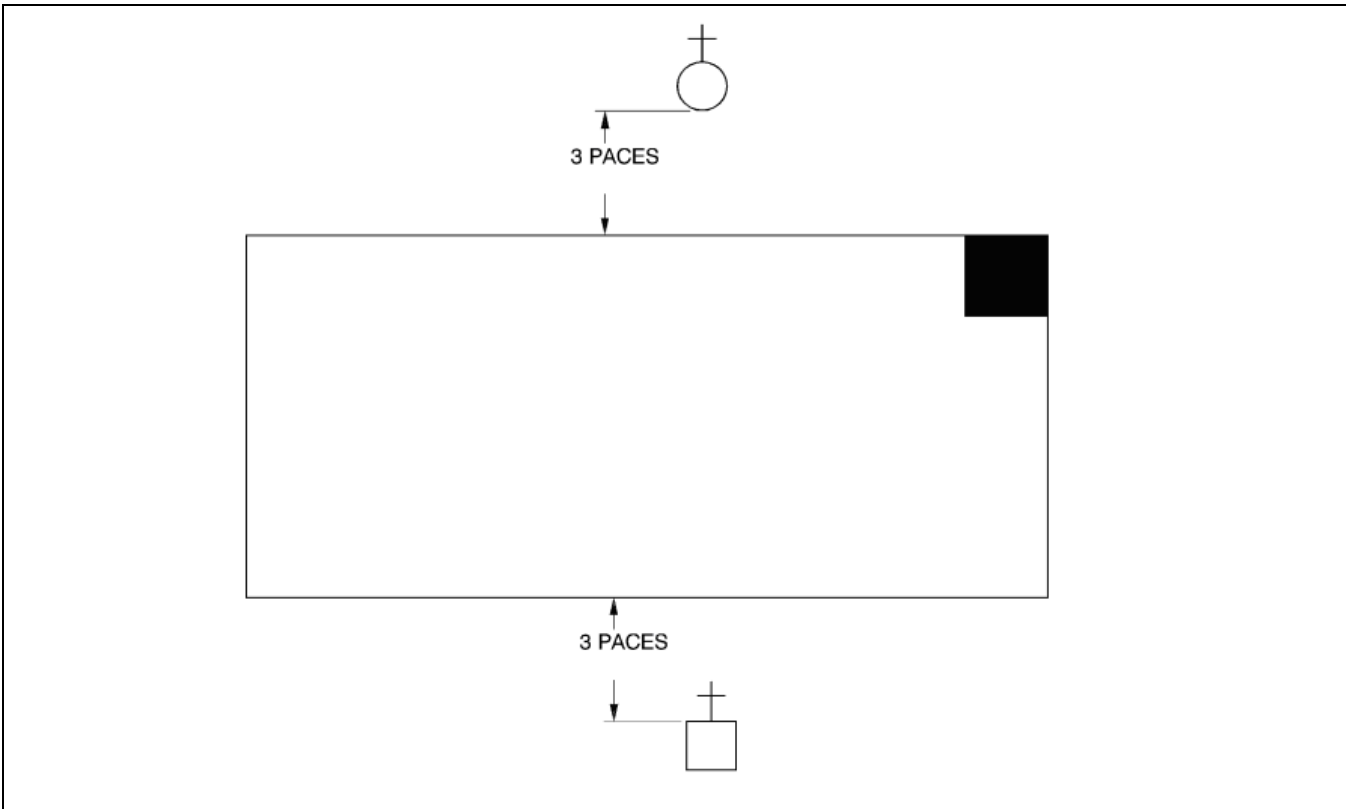

Figure 7-2- 1 Platoon in Line

PLATOON IN COLUMN OF THREES

8. A platoon in column of threes is in the same formation as when in line, but facing a flank (Figure 7-2-2). Column of threes is the formation used by a platoon second in command to move platoons on the march.

PLATOON IN COLUMN OF ROUTE

9. Column of route is similar to column of threes, except that the platoon commander is two paces in front of the centre single file of the platoon and the platoon warrant officer is two paces in rear of the centre single file of the platoon (Figure 7-2-3). Column of route is the formation most commonly used by platoon commanders to move platoons on the march.

DRESSING A PLATOON

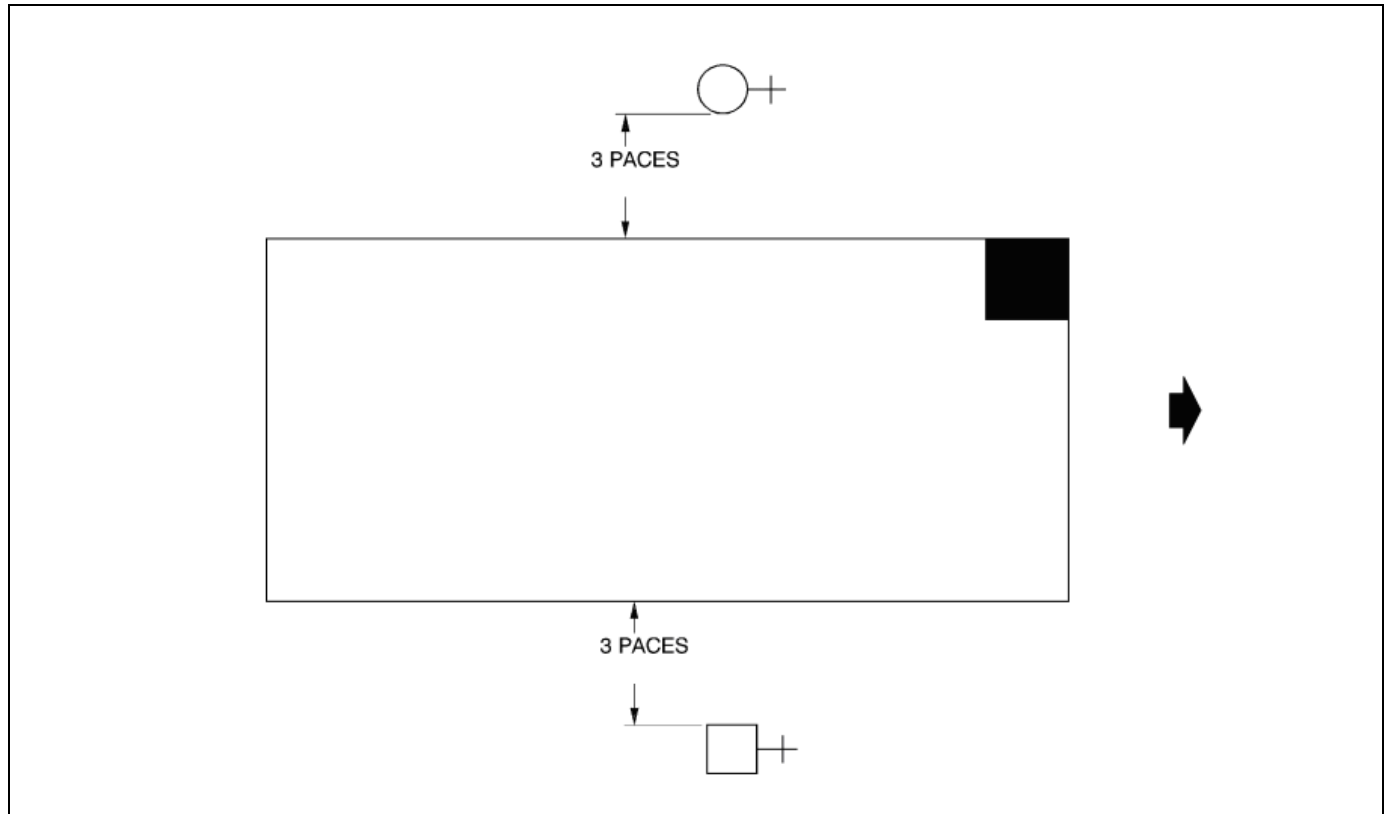

Figure 7-2- 2 Platoon in Column of Threes

10. When the platoon commander wishes to dress the platoon at the halt, he shall face the platoon and order SHOULDER (ELBOW) DRESSING, RIGHT (LEFT) – DRESS:

- a. The platoon then acts as ordered.
- b. The platoon warrant officer:
 - (1) steps off, wheels to the right and marches six paces to the right of the right flank, wheels to the left and halts, facing and in line with the front rank;
 - (2) turns left and dresses the front rank. When the front rank is dressed, he orders FRONT RANK – STEADY;
 - (3) turns left, and, keeping his arms at the side, paces off the interval, halts, turns right, and dresses the centre rank. He then orders CENTRE RANK – STEADY; and
 - (4) turns left, keeping his arms at the side, again paces off the interval, halts, turns right, and dresses the rear rank. He then orders REAR RANK – STEADY.
- c. The platoon commander then orders EYES – FRONT. The platoon will act as ordered and the platoon warrant officer will step off and, by a series of wheels, returns to his original position in the rear of the platoon.

11. When the platoon warrant officer is in command of the platoon and orders the right dress, the procedure above is followed. The command EYES – FRONT is ordered by the platoon warrant officer after he returns to his position in front of the platoon.

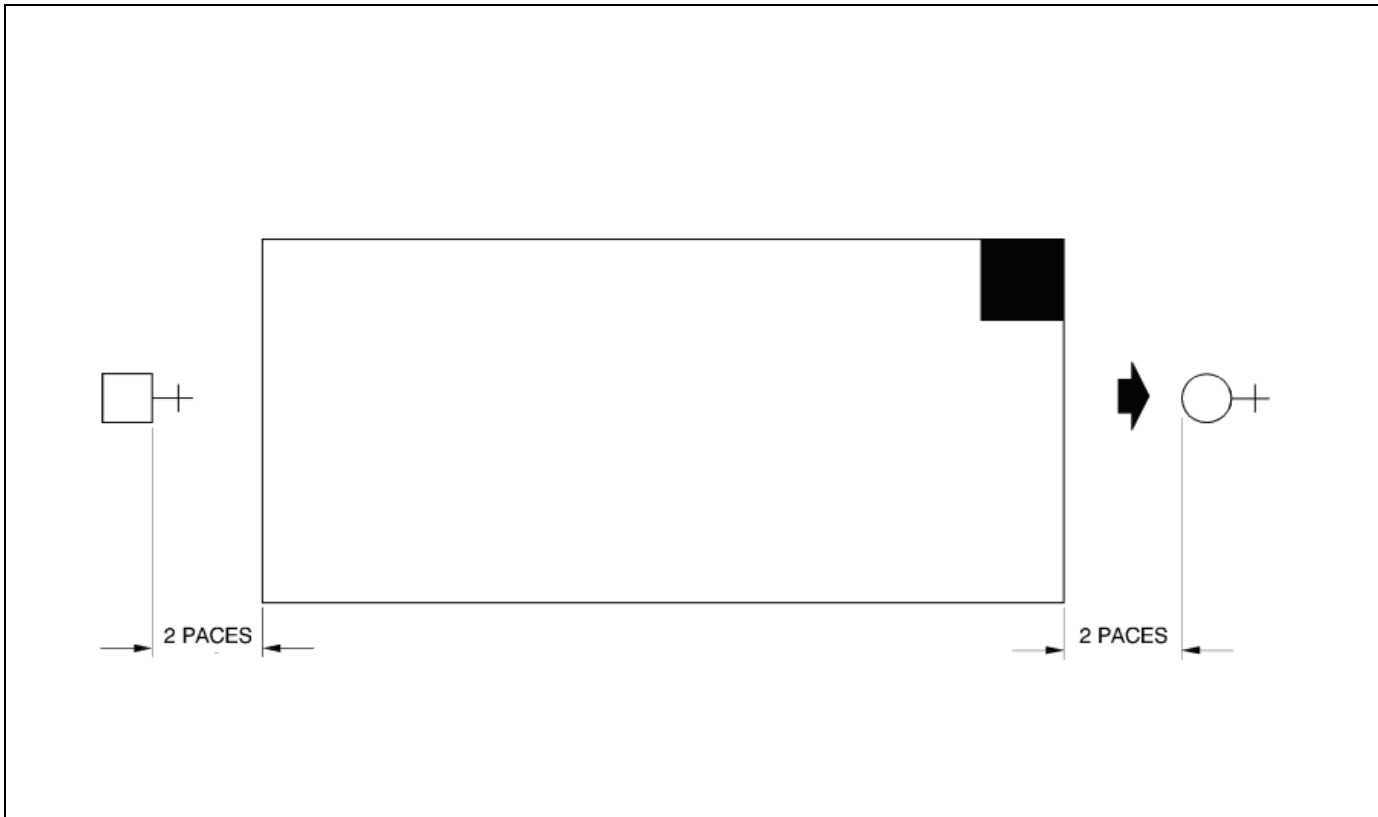

Figure 7-2- 3 Platoon in Column of Route

ORDERING A PLATOON ON PARADE

12. A platoon is ordered on parade in a similar manner to falling in a squad (see Chapter 2).
13. The platoon warrant officer may then call the roll, size the platoon, etc.
14. Supernumerary officers, warrant officers and senior non-commissioned officers act as follows:
 - a. The warrant officers and senior non-commissioned officers will form up in a supernumerary rank, three paces behind the rear rank, evenly spaced across the platoon frontage. They will act on the orders of the platoon warrant officer.
 - b. Supernumerary officers will be ordered to fall in by the platoon commander after he has taken over command as in company drill, Section 3, paragraph 28 and section 3, table 7-3-1, No.20.
15. The platoon shall be handed over to the platoon commander in the following manner:
 - a. The platoon warrant officer calls the platoon to attention as the platoon commander approaches.
 - b. The platoon commander halts two paces in front of the platoon warrant officer, who salutes and, when his salute has been acknowledged, reports the strength, condition, etc., of the platoon.
 - c. Upon being ordered to fall in, the platoon warrant officer salutes and, after the salute has been acknowledged, turns right and proceeds by a series of wheels around the right flank to take up his position in rear of the platoon.
 - d. The platoon commander marches forward two paces to take up his position.

- 13 PLATOON DRILL CONTINUES.
- 12 PLATOON WILL ADVANCE IN COLUMN OF THREES FROM THE LEFT, LEFT-TURN, RIGHT WHEEL, BY THE RIGHT, QUICK-MARCH.
- 11 PLATOON, HALT, ADVANCE, ABOUT-TURN
- 10 PLATOON WILL RETIRE, ABOUT TURN. BY THE LEFT, QUICK-MARCH.
- 9 PLATOON, AT THE HALT, CHANGE DIRECTION RIGHT, RIGHT-FORM.
- 8 PLATOON, CHANGE DIRECTION LEFT, LEFT-FORM. FORWARD, BY THE RIGHT.
- 7 PLATOON, ON THE LEFT, FORM-PLATOON. FORWARD.
- 6 LEFT WHEEL. BY THE LEFT.
- 5 PLATOON WILL MOVE TO THE RIGHT IN COLUMN OF THREES, RIGHT-TURN.
- 4 PLATOON WILL ADVANCE BY THE RIGHT, QUICK-MARCH.
- 3 PLATOON, HALT. PLATOON WILL ADVANCE LEFT-TURN.
- 2 PLATOON IN COLUMN OF ROUTE, MARCHES TO THE TRAINING GROUND.
- 1 PLATOON AT BARRACKS ON PARADE IN LINE. COMMAND: MOVE TO THE RIGHT IN COLUMN OF ROUTE, RIGHT - TURN BY THE LEFT, QUICK - MARCH.

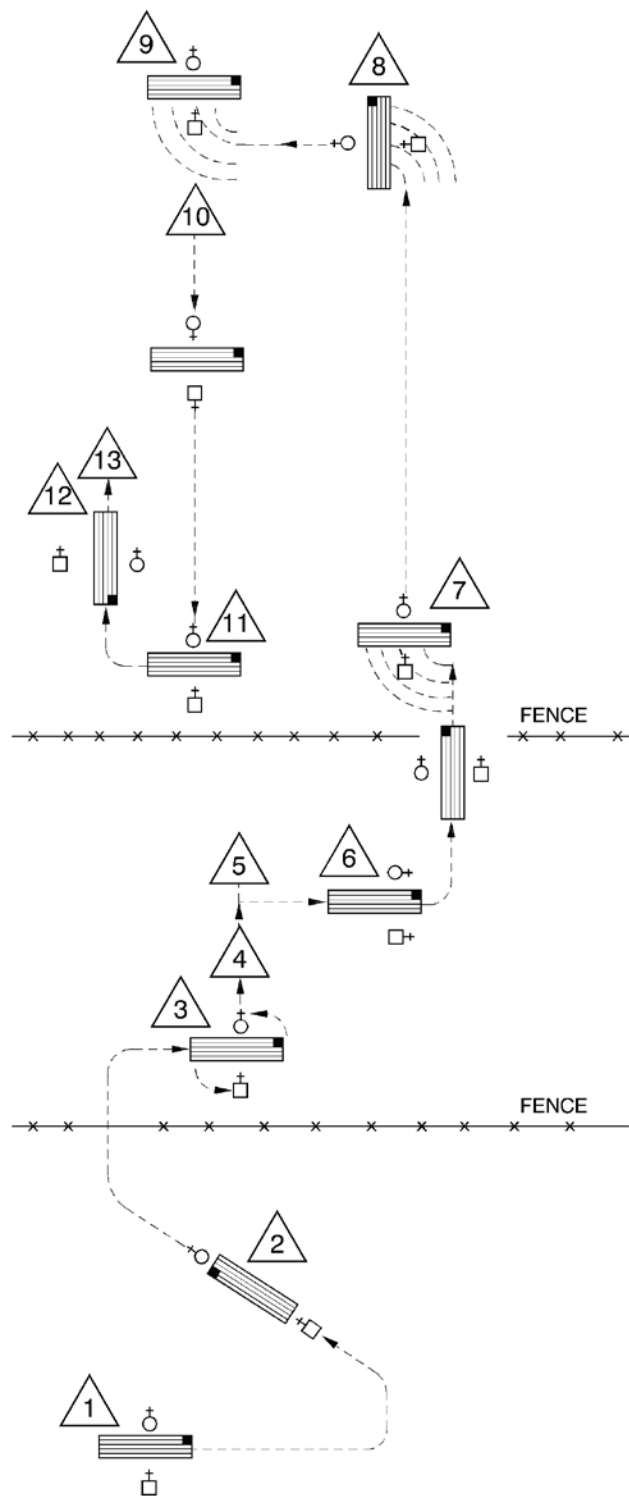

Figure 7-2- 4 Platoon Drill

PLATOON IN LINE ADVANCING AND RETIRING

16. In line, the platoon is advancing when the original front rank is leading, and retiring when the original rear rank is leading (Figure 7-2-1).

17. To advance, the command shall be PLATOON WILL ADVANCE BY THE RIGHT, QUICK – MARCH. The platoon commander and platoon warrant officer maintain their relative positions.

18. On the command PLATOON WILL RETIRE, ABOUT – TURN, the platoon turns about. The platoon commander and platoon warrant officer maintain their position.

PLATOON MOVING TO THE RIGHT OR LEFT IN COLUMN OF THREES

19. On the command PLATOON WILL MOVE TO THE RIGHT (LEFT) IN COLUMN OF THREES, RIGHT (LEFT) – TURN, the platoon acts as ordered. The platoon commander and platoon warrant officer turn in the appropriate direction and maintain their positions.

PLATOON MOVING TO THE RIGHT OR LEFT IN COLUMN OF ROUTE

20. On the command PLATOON WILL MOVE TO THE RIGHT (LEFT) IN COLUMN OF ROUTE, RIGHT (LEFT) – TURN:

- a. the platoon will act as ordered; and
- b. the platoon commander and platoon warrant officer will turn in the appropriate direction, observe the standard pause and move to their positions in front and rear of the platoon.

PLATOON ADVANCING AND RETIRING IN COLUMN OF THREES

21. The cautionary command ADVANCE (RETIRE) IN COLUMN OF THREES, warn the platoon of a turn, followed immediately by a wheel in the indicated direction.

22. The command shall be PLATOON WILL ADVANCE IN COLUMN OF THREES FROM THE RIGHT (LEFT), RIGHT (LEFT) – TURN.

23. This command shall be followed by, LEFT (RIGHT) WHEEL BY THE LEFT (RIGHT), QUICK – MARCH. The platoon wheels as it steps off.

24. To retire, the commands are:

- a. PLATOON WILL RETIRE IN COLUMN OF THREES FROM THE RIGHT (LEFT), RIGHT (LEFT) – TURN;
- b. RIGHT (LEFT) WHEEL, BY THE RIGHT (LEFT), QUICK – MARCH; and
- c. on completion of the wheel, the platoon commander normally orders, BY THE LEFT (RIGHT) to ensure dressing by the original front rank.

PLATOON ADVANCING AND RETIRING IN COLUMN OF ROUTE

25. The cautionary command ADVANCE (RETIRE) IN COLUMN OF ROUTE warns the platoon of a turn, followed immediately by a wheel in the indicated direction.

26. The command shall be PLATOON WILL ADVANCE IN COLUMN OF ROUTE FROM THE RIGHT (LEFT), RIGHT (LEFT) – TURN.

27. After the platoon commander and platoon warrant officer take up their new positions, this command shall be followed by LEFT (RIGHT) WHEEL, BY THE LEFT (RIGHT), QUICK – MARCH. The platoon wheels as it steps off.

28. To retire, the commands are:

- a. PLATOON WILL RETIRE IN COLUMN OF ROUTE FROM THE RIGHT (LEFT), RIGHT (LEFT) – TURN;
- b. RIGHT (LEFT) WHEEL, BY THE RIGHT (LEFT), QUICK – MARCH; and
- c. on completion of the wheel, the platoon commander normally orders BY THE LEFT (RIGHT) to ensure dressing by the original front rank.

PLATOON MOVING TO A FLANK, REQUIRED TO TURN ABOUT

29. On the command PLATOON MOVE TO THE RIGHT (LEFT) IN THREES (COLUMN OF ROUTE), ABOUT – TURN:

- a. The platoon will act as ordered.
- b. If in column of threes and remaining in column of threes, the platoon commander and platoon warrant officer shall turn about and maintain their relative positions.
- c. If column of route is ordered, the platoon commander and platoon warrant officer shall turn about, change into double time, and double to their new positions two paces in front and rear of the centre file (the platoon commander doubling past the front rank and the platoon warrant officer past the rear rank), where they will change back into quick time.

SECTION 3

COMPANY DRILL

INTRODUCTION

1. A company consists of two or more platoons. It is commanded by a company commander, assisted by a deputy company commander and a master warrant officer. Other officers, warrant officers and senior non-commissioned officers not directly involved with the platoons shall be supernumeraries and form supernumerary ranks as directed by the company commander.
2. Whenever space is limited, intervals and distances between units or sub-units may be decreased.
3. When a company is formed on parade and arms are carried, the platoons and company themselves may be handed over to their respective commanders at either the shoulder or order arms position, except that the master warrant officer and the platoon warrant officer shall adopt the shoulder arms position upon the approach of their respective officers.
4. For simplicity and as an example, this section uses "A" Company, consisting of Nos. 1, 2 and 3 Platoons.

COMPANY FORMATIONS

5. **General.** Company formations are:
 - a. line;
 - b. column of threes;
 - c. column of route;
 - d. column of platoons (only used as part of battalion drill but must be practised at company level); and
 - e. close column of platoons (only used as part of battalion drill but must be practised at company level).

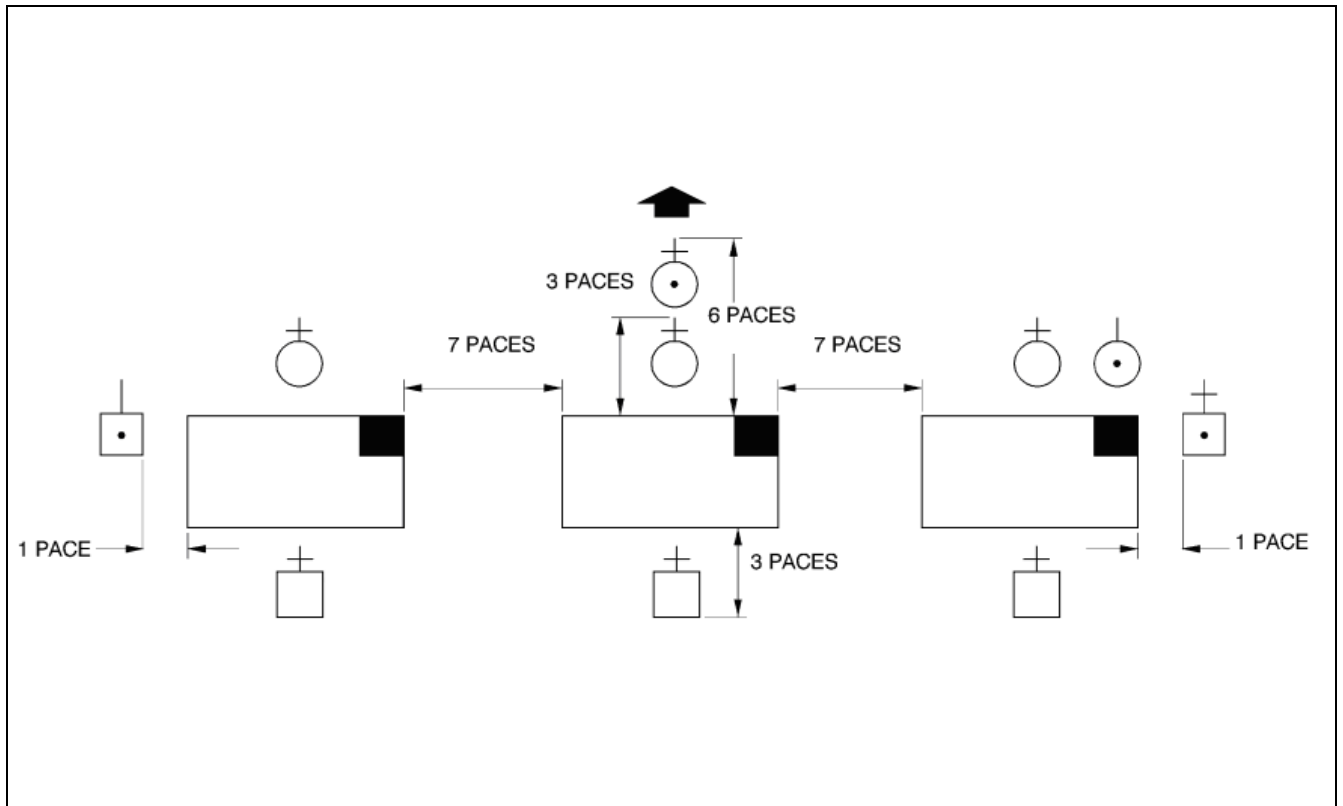

Figure 7-3- 1 Company in Line

6. **Company in Line.** When a company is formed in line (Figure 7-3-1):
 - a. the platoons are side-by-side on the same alignment, with a seven pace interval between platoons;
 - b. each platoon is formed as in platoon drill;
 - c. the company commander is centred three paces in front of the line of platoon commanders;
 - d. the deputy commander is in line with the platoon commanders and three paces in front of the second single file from the right flank of the company;
 - e. the master warrant officer (right guide) is one pace to the right of the No. 1 Platoon marker, in line with the front rank;
 - f. the warrant officer (left guide) is one pace to the left of the left flank of the company, in line with the front rank;
 - g. any supernumerary officers are evenly distributed across the frontage of the platoons, in line with the platoon commanders; and
 - h. any supernumerary warrant officers and senior non-commissioned officers are evenly distributed across the rear of the platoons, in line with the platoon warrant officers.

7. **Company in Column of Threes.** A company formed in column of threes is in the same formation as when in line, but facing a flank (Figure 7-3-2).

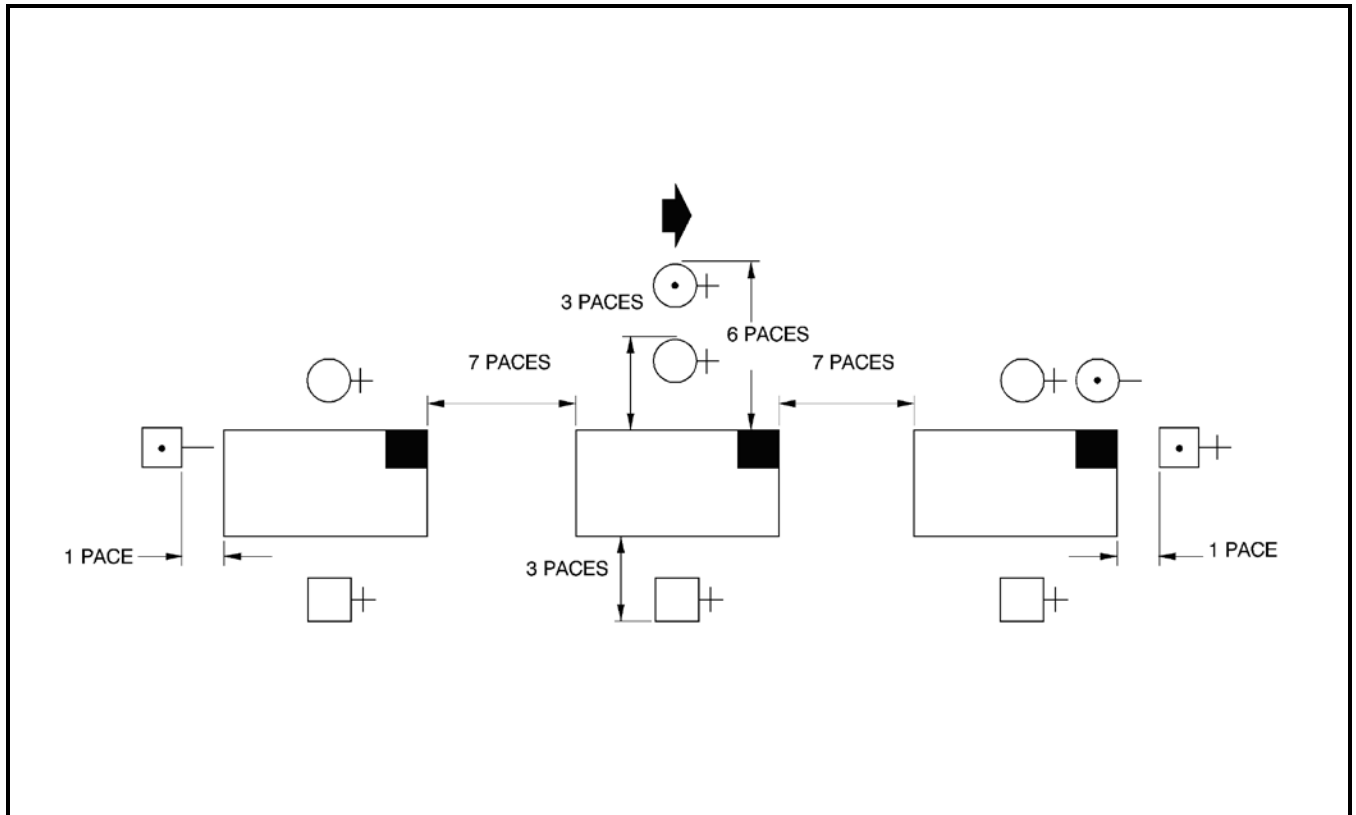

Figure 7-3- 2 Company in Column of Threes

8. **Company in Column of Route.** A company in column of route (Figure 7-3-3) is similar to one in threes, except that:

- a. the company commander is centred two paces in front of the leading platoon commander;
- b. the deputy commander is centred two paces behind the rear platoon warrant officer;
- c. the master warrant officer (right guide) is one pace in front of the directing flank of the leading platoon;
- d. the warrant officer (left guide) is one pace in rear of the directing flank of the last platoon;
- e. if supernumerary officers are present, they are two paces in front of their respective platoons and the company commander and platoon commanders concerned are one pace further forward than normal to provide room; and
- f. if supernumerary warrant officers and senior non-commissioned officers are present, they are one pace in rear of their respective platoons, while the warrant officer left guide and the platoon warrant officers concerned are one pace in rear of their normal positions to provide room.

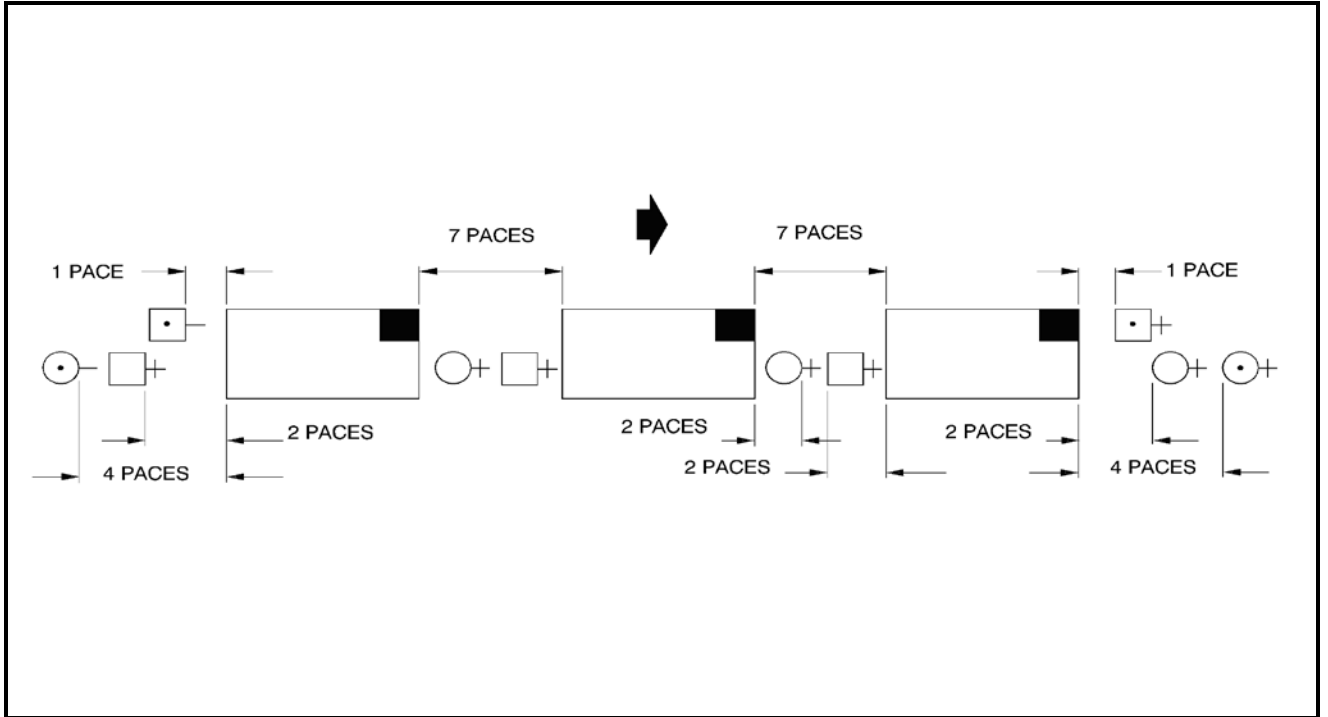

Figure 7-3-3 Company in Column of Route

9. **Company in Column of Platoons.** A company in column of platoons is formed with each platoon in line, one behind the other (Figure 7-3-4). If the platoons are of unequal strength, the leading platoon will be the strongest. The distance between platoons is the frontage of the leading platoon, plus seven paces, the minimum distance is 12 paces (i.e., the distance for close column, see paragraph 10):

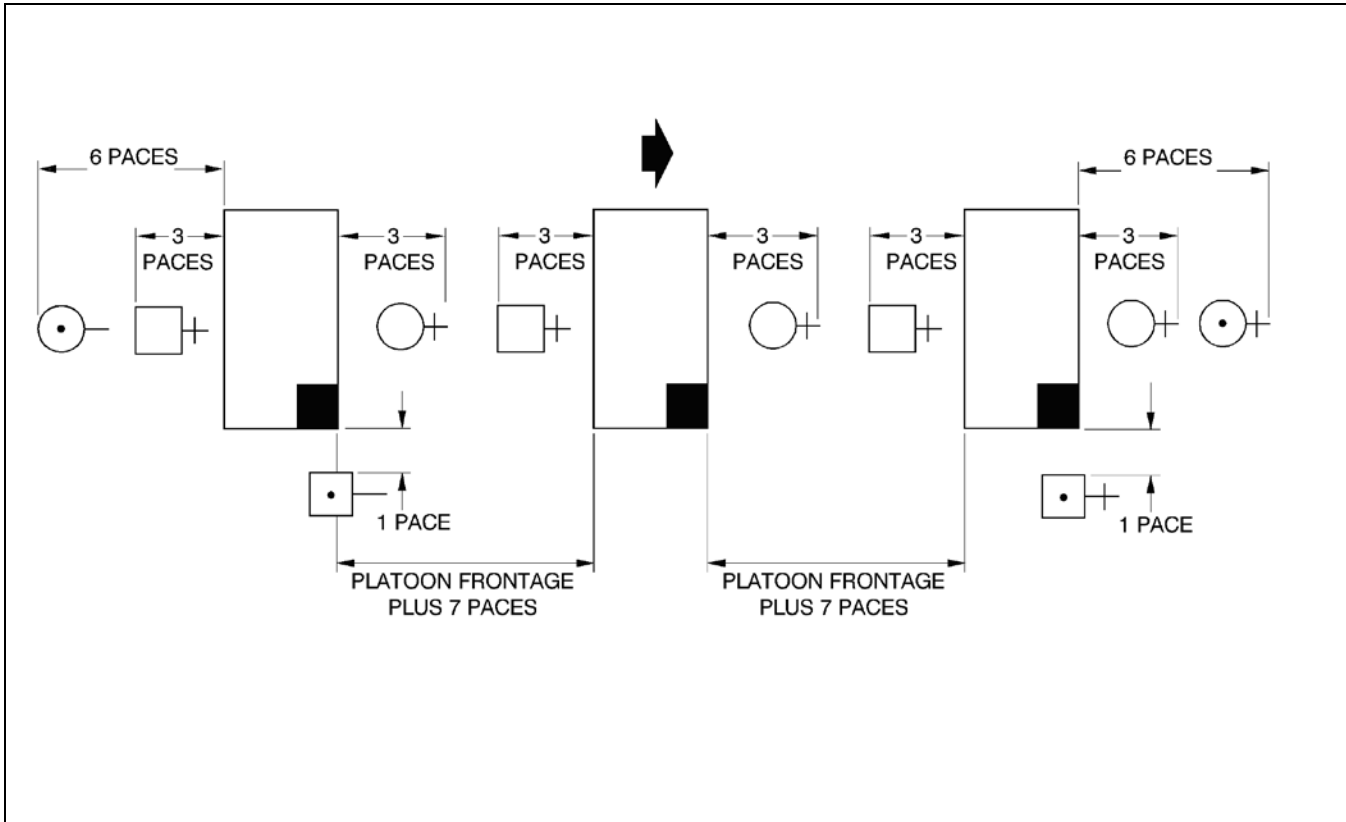

Figure 7-3- 4 Company in Column of Platoons

- a. The company commander is centred three paces in front of the leading platoon commander.
- b. The deputy commander is centred three paces in rear of the rear platoon warrant officer.
- c. The master warrant officer is one pace to the right and in line with the front rank of the leading platoon.
- d. The warrant officer is one pace to the right and in line with the front rank of the rear platoon.
- e. Supernumerary officers are evenly spaced three paces in front of the platoon, in line with the platoon commanders.
- f. Any supernumerary warrant officers and non-commissioned officers are three paces in rear of the platoon with which they are parading, in line with the platoon warrant officers.

10. **Company in Close Column of Platoons.** A company formed in close column of platoons maintains the same formation in all detail as for column of platoons except that the minimum distance between platoons is 12 paces, however, the distance between platoons may be reduced to suit the circumstances, but remains the same between each platoon.

TELLING OFF A COMPANY

11. If troops are not part of a formally established unit and do not parade together regularly, it may be necessary to organize and identify individual platoons. For newly assembled troops, they will normally first be divided into equal groups, often after being sized.

12. The master warrant officer shall assemble the platoons in a convenient order. On the master warrant officer's command TELL OFF BY PLATOONS, the platoon warrant officers call out in succession:

- a. No. 1 PLATOON;
 - b. No. 2; and
 - c. No. 3 PLATOON.
13. The master warrant officer then orders, 1, 2 and 3 PLATOONS SHALL FORM "A" COMPANY.
14. Only the first and last sub-units use the word "platoon". Thus this word indicates the start of the telling off and that all have replied.

DRESSING A COMPANY IN LINE

15. At the completion of all company drill movements, when a company is halted in line, the company shall be dressed.
16. On the command RIGHT – DRESS, by the company commander:
- a. The officers about turn, turn their head and eyes to the left and dress on the second in command, then turn their head and eyes back to supervise the dressing of those under their command.
 - b. The platoon warrant officer and supernumerary warrant officers and non-commissioned officers turn their head and eyes to the right and dress on the non-commissioned officer on the right flank, who looks straight to the front.
 - c. The members in the ranks dress by the right; the right hand single file of the company look straight to their front.
 - d. The platoon warrant officers of No. 2 and 3 Platoons shall pace off the proper interval between the platoon on their right and their own platoon and position their markers accordingly. Upon completion, they shall return to their normal positions in line and dress by their right.
 - e. The master warrant officer turns right and marches five paces to the right of the company, about turns and dresses each rank in succession in a similar manner to dressing a platoon as detailed in Section 2, paragraph 11.
 - f. When the master warrant officer orders REAR RANK – STEADY, the company commander shall give the command EYES – FRONT.
17. On the command EYES – FRONT:
- a. officers about turn;
 - b. the master warrant officer returns to his original position; and
 - c. the remainder of the company act as ordered.
18. When the master warrant officer is in charge of the company and orders right dress, the platoon warrant officer of the right hand platoon will act as detailed in Section 2, paragraph 11 and dress the company.

DRESSING A COMPANY IN COLUMN AND CLOSE COLUMN OF PLATOONS

19. At the completion of all company drill movements, when a company has been halted in column or close column of platoons, the company shall be dressed.
20. On the command RIGHT – DRESS by the company commander:
- a. All officers about turn and supervise the dressing, at the same time taking up their proper distance and dressing.

- b. The platoons act as ordered.
- c. The platoon warrant officers take up their positions six paces to the right of their front ranks as detailed in Section 2, paragraph 11.
- d. The master warrant officer marches forward to a position six paces in front of the right marker of the leading platoon, halts, turns about and ensures that the right hand file of each platoon is covered correctly and then orders RIGHT FLANK – STEADY.

21. On the command RIGHT FLANK – STEADY, the platoon warrant officers dress their platoons normally. When the dressing has been completed, the platoon WOs shall, in succession, order NO. 1 PLATOON – STEADY; NO. 2 – STEADY; NO. 3 PLATOON – STEADY.

22. On the command NO. 3 PLATOON – STEADY, the company commander orders “A” COMPANY, EYES – FRONT.

23. On the command “A” COMPANY, EYES – FRONT:

- a. officers about turn;
- b. the master warrant officer returns to his original position;
- c. the platoon warrant officers return to their normal positions; and
- d. the remainder of the company acts as ordered.

FORMING UP A COMPANY

24. Prior to forming the company, the platoon warrant officers call the roll and inspect their platoons. They then position their platoons (sized, if so ordered) as directed by the master warrant officer, normally at the edge of the parade ground. They shall report their platoon strengths to the master warrant officer prior to the markers being called.

25. A company may be formed up in one of the following formations:

- a. line;
- b. column of platoon; and
- c. close column of platoons.

26. The company is normally formed up in the centre of the allotted parade ground. Knowing the company's strength and frontage, the master warrant officer selects the position to fall in the markers, by:

- a. dividing the frontage of the company's leading (and largest) platoon by two and marching off an equal number of paces to the right flank from where the company will be centred, for column or close column of platoons, and
- b. dividing the company's frontage, including intervals, in two and marching the appropriate number of paces to the right flank, for line.

27. The words of command and the action taken to form up a company are detailed in Table 7-3-1.

No.	Command	By	Action	Remarks
1			The MWO marches to and halts in a position three paces to the left of and facing the position to be occupied by the marker of No. 1 Platoon.	The platoons are normally positioned at the edge of the parade ground, standing easy. The MWO shall face the future position of the front rank if the company is to form up in line, and the right flank if the company is to form up in (close) column of platoons.
2	MARKERS	MWO	The platoon markers come to attention, shoulder arms, and march onto the parade ground. The marker of No. 1 Platoon halts three paces in front of and facing the MWO. The remainder halt on the left of the No. 1 Platoon marker and dress to the right at shoulder dressing. Upon completion of dressing they look to the front in succession from the right. The markers remain at the shoulder arms.	Platoons formed on the edge of the parade ground adopt the stand at ease position. Standard pauses are observed between drill movements.
3	MARKERS – NUMBER	MWO	Markers number in succession from the right, e.g. “one”, “two”, etc.	
4	NO. 1 PLATOON, RIGHT, REMAINDER LEFT – TURN	MWO	No. 1 Platoon marker turns right, the remainder turn left.	The MWO specifies the number of paces to be taken by Nos. 2 and 3 Platoon markers after completion of the left turn.
5	NO. 1 PLATOON, STAND FAST, REMAINDER, QUICK – MARCH	MWO	No. 1 Platoon marker stands fast, the remainder quick march the required distance and halt.	
6	NO. 1 PLATOON, STAND FAST, REMAINDER ABOUT – TURN	MWO	No. 1 Platoon marker stands fast, the remainder about turn and cover off the No. 1 Platoon marker.	The MWO by wheeling, marches out six paces in front of No. 1 Platoon marker and ensures the markers are covered off.
7	MARKERS – STEADY	MWO	The markers stand fast.	If the company is being formed up in line, the MWO shall proceed as detailed in No. 7a. If in column or close column, the MWO turns right, marches to and halts in a position six paces in front and centre of where the front platoon will be and turns left, facing the future company position. The MWO then proceeds as detailed in No 8.
7a	MARKERS, LEFT – TURN	MWO	The markers turn left.	This order places the markers in line. The MWO then, by wheeling, positions himself six paces in front of and facing the future centre of the company.
8	__ COMPANY, FALL – IN	MWO	The platoon WOs come to attention, about turn, facing their respective platoons together.	

Table 7-3-1 (Sheet 1 of 3) Forming Up a Company

No.	Command	By	Action	Remarks
9	NO. 1 PLATOON, ATTEN – TION	No. 1 PI WO	The platoon acts as ordered.	Nos. 2 and 3 Platoon WOs order their platoons to attention in succession, following No. 1 Platoon.
10	NO. 1 PLATOON, SHOULDER – ARMS	No. 1 PI WO	The platoon acts as ordered.	Nos. 2 and 3 Platoon WOs similarly order their platoons in succession following No. 1 Platoon.
11	NO. 1 PLATOON, (RIGHT – TURN;) QUICK – MARCH	No. 1 PI WO	The platoon acts as ordered and marches.	As above.
12	NO. 1 PLATOON – HALT	No. 1 PI WO	The platoon halts on its marker.	As above. As the platoons fall in, the officers move to the parade ground and begin the promenade, normally on the flank.
13	NO. 1 PLATOON, ADVANCE, LEFT – TURN	No. 1 PI WO	The platoon acts as ordered.	As above. As the No. 3 Platoon WO gives the command LEFT – TURN, all three WOs will turn about and face the front together.
14	__ COMPANY, ORDER – ARMS	MWO	The company acts as ordered.	
15	__ COMPANY, OPEN ORDER – MARCH	MWO	The company acts as ordered.	
16	__ COMPANY, RIGHT – DRESS	MWO	The company acts as ordered.	The MWO and platoon WOs dress the company.
17	__ COMPANY, EYES – FRONT	MWO	The company acts as ordered.	
18	REPORT YOUR – PLATOONS	MWO	Platoons WOs report their platoons.	Platoons WOs, when indicating their platoons, shall use the procedure for telling off platoons. Meanwhile, the officers position themselves ready to fall in. The deputy company commander (DComd) shall position himself two paces behind the MWO.
19			The MWO turns about, salutes and reports the company to the DComd. The DComd orders the MWO to fall in. The MWO salutes, turns right and marches to his position on parade. The DComd takes two paces forward to assume MWO's former position.	All salutes are acknowledged. The DComd shall wait until the MWO has adopted his new position before giving any further commands.

Table 7-3-1 (Sheet 2 of 3) Forming Up a Company

No.	Command	By	Action	Remarks
20	OFFICERS, FALL – IN	DComd	The officers acts as ordered.	Platoon WOs report their platoons and, after being ordered to fall in, turn right and march to their new positions. The company is now ready, at the appointed time, to receive its company commander (Coy Comd). The latter marches onto the parade ground and positions himself two paces from the DComd. The DComd turns about and calls the company to attention as the Coy Comd approaches.
21	— COMPANY, ATTEN – TION	DComd	The DComd salutes and reports the company to its commander. The Coy Comd orders the DComd to fall in. The DComd salutes, turns right and by a succession of wheels marches to his position on parade. The Coy Comd steps forward two paces adopting the position formerly occupied by the DComd.	All salutes are acknowledged. The Coy Comd waits until the DComd has adopted his new position before issuing any further orders.
22	— COMPANY, STAND AT – EASE	Coy Comd	The company acts as ordered.	The Coy Comd carries on by inspecting the platoons, having the platoon commanders inspect their own platoons, or proceeding with training or ceremonial.

Table 7-3-1 (Sheet 3 of 3) Forming Up a Company

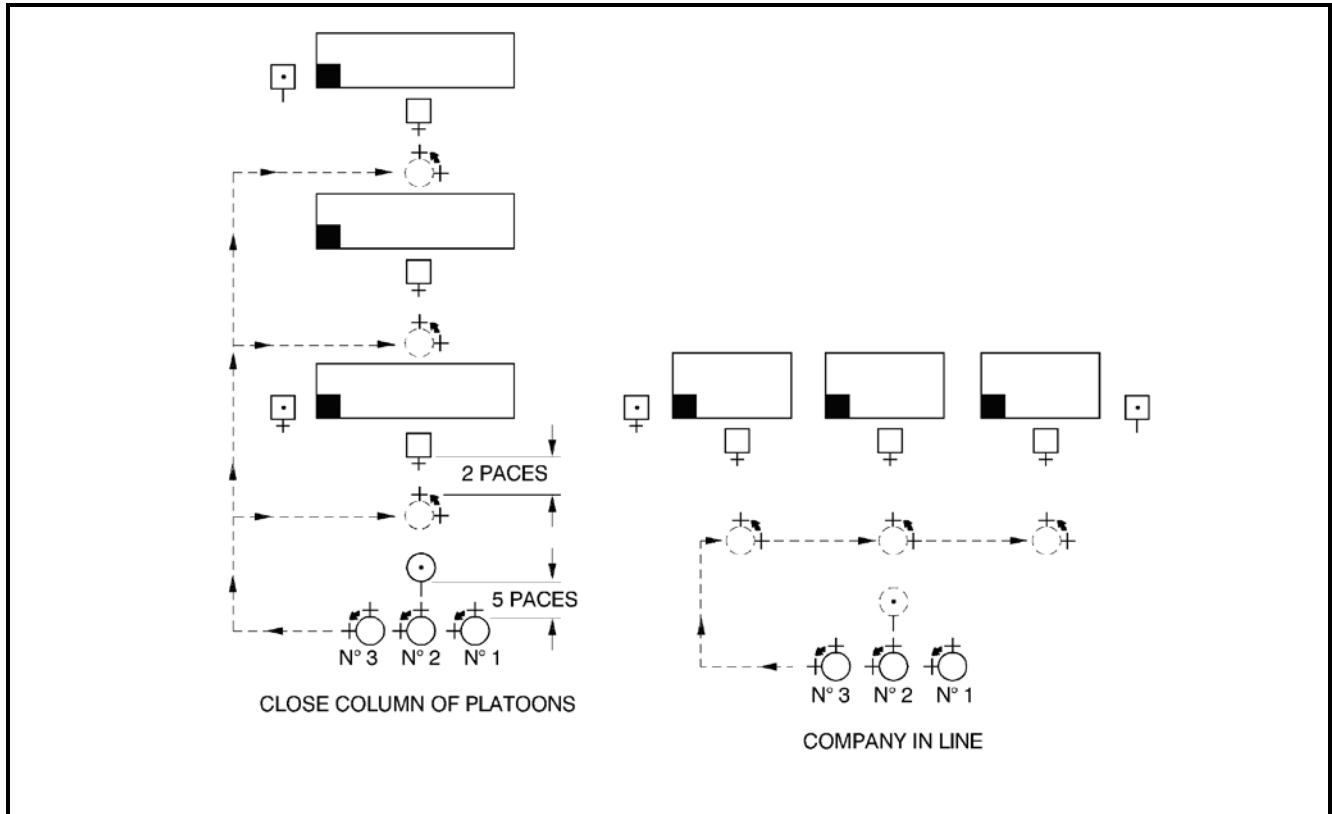

Figure 7-3- 5 Officers Fall in

FALLING IN THE OFFICERS

28. The officers may commence promenading after the platoons have fallen in (Table 7-3-1, Item 12; see also Chapter 9, Section 1, paragraph 7). They continue until the deputy commander is ready to assume command of the company from the master warrant officer.

29. The platoon commanders and supernumerary officers position themselves five paces in rear of and centred on the deputy commander. Dressing is automatic and officers stand at ease in succession from the right.

30. After the deputy commander has ordered the master warrant officer to fall in and has moved to the master warrant officer's former position, he will turn about and order the officers to fall in.

31. On the command OFFICERS FALL – IN by the deputy commander, the officers come to attention, salute, turn left and march to their respective platoons, approaching their platoon warrant officers from the right flank front (Figure 7-3-5).

32. Each platoon is handed over to its commander following the same procedure as for a platoon parading independently. Once the platoon warrant officers are in their new positions, the platoons are stood at ease by their commanders in succession from the front (right). On the executive word of command of the last platoon commander ordering his platoon to stand at ease, platoon commanders turn about and stand at ease together.

COMPANY COMMANDER'S INSPECTION

33. Inspections are carried out at the open order.

34. When company commanders wish to inspect their companies, they do so one platoon at a time, normally accompanied by the appropriate platoon commanders and the deputy company commanders and master warrant officers. The company commander orders NO. 1 PLATOON, STAND FAST, REMAINDER STAND AT – EASE and then inspects the company, commencing with the platoon ordered to stand fast.

35. As the company commander approaches the platoon that has been ordered to stand fast, the platoon commander turns right and moves to a position three paces in front of his platoon marker, where he shall salute the company commander and report his platoon (Figure 7-3-6). The remaining platoon commanders will observe the company commander, and as he commences inspecting the rear rank of the preceding platoon, they shall turn about to face their platoon, order their platoon to attention, turn left, and move to a position three paces in front of their respective markers, where they shall salute the company commander on his arrival and report their platoons.

36. When the company commander does not wish to inspect the company personally, he may order the platoon commanders to carry on with the inspection. Platoon commanders then inspect their platoons, accompanied by the platoon warrant officers.

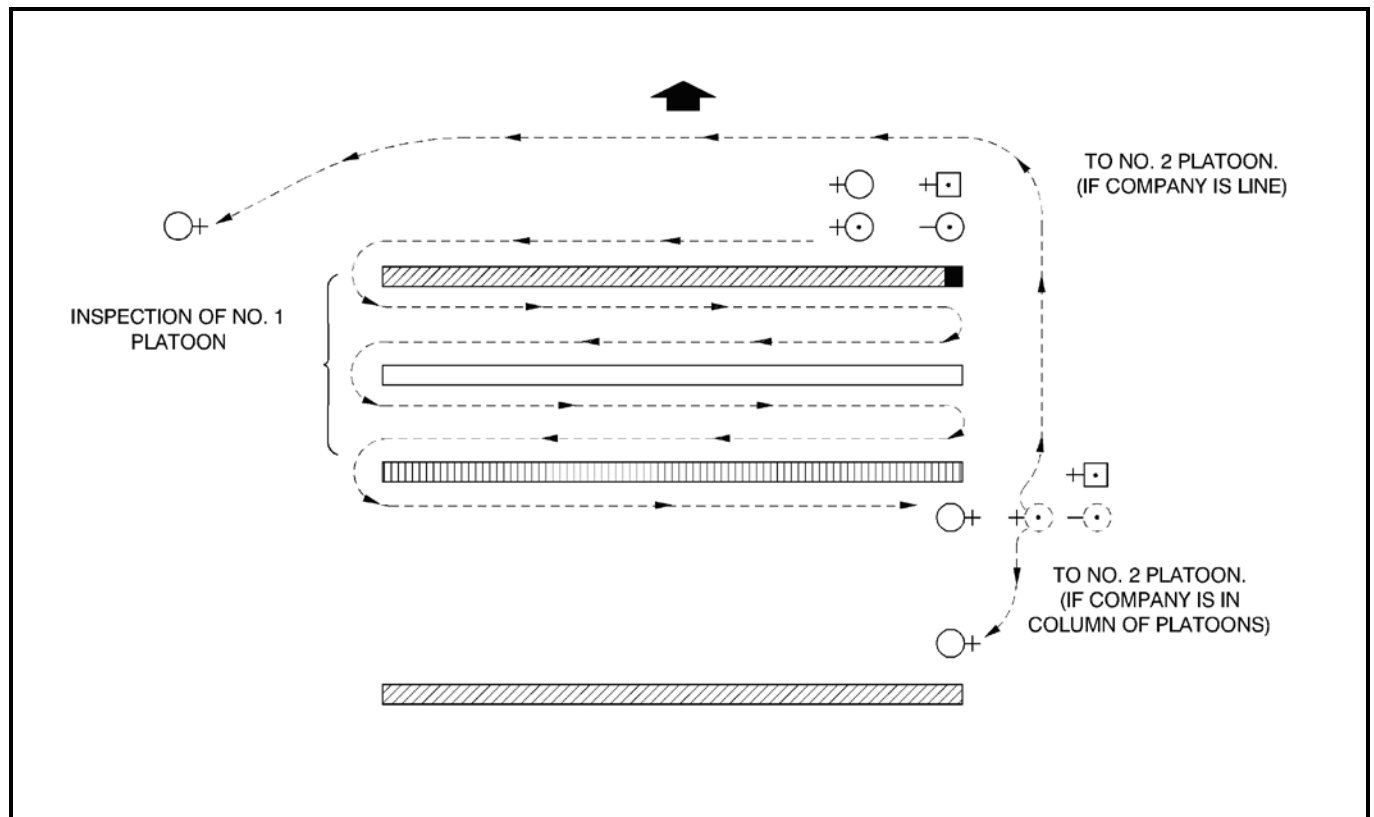

Figure 7-3- 6 Company Commander’s Inspection: Company in Line, Column or Close Column of Platoons

37. When the inspection of a platoon is completed, the platoon commander shall return to the platoon’s centre front, order close order march and stand at ease, following which the platoon commander will turn about to face the front, stand at ease, and await further orders from the company commander.

38. When the inspection of the company is completed the company commander orders “A” COMPANY, ATTEN – TION, and then:

- a. exercises the company in drill or otherwise carries on with the purpose of the parade (Figure 7-3-7 and subsequent articles);

- b. turns the company over to the deputy commander;
- c. falls out the officers and turns the company over to the master warrant officer; or
- d. falls out the deputy commander, the master warrant officer and the warrant officer (left guide) and orders platoon commanders to carry on with platoon duties.

FALLING OUT THE OFFICERS

39. Prior to giving the order for officers to fall out, the company commander positions himself so that officers may halt at the required distance in front of him, with sufficient space left for the platoon warrant to occupy the position vacated by the platoon commander of the first platoon when in column, or the centre platoon when in line.

40. The command OFFICERS, FALL – OUT is given by the company commander when the company is at attention.

41. The officers march by the most direct route and form up in a line, five paces in front of, centred on and facing, the company commander, at arm's length interval (without raising the arm), the deputy commander on the right. When all are present and in line, the deputy commander shall take a half pace forward. As his right foot completes the movement, all officers will observe a standard pause and salute. After the company commander has finished speaking to them, they salute together and march five paces behind, halt in line, turn about, return swords and stand at ease. When ordered by the company commander to DIS – MISS, the deputy commander will step back one half pace. All officers will observe the standard pause, salute with the hand and march straight off the parade ground.

42. On the command OFFICERS, FALL – OUT, the platoon warrant officers march around the left flank of their platoons and occupy the positions vacated by the platoon commanders. If arms are being carried, the platoon warrant officers shall shoulder arms prior to moving around the left flank and, upon arriving at their new position, they shall order arms.

43. When the platoon warrant officers are in position and the officers have been dismissed, the company commander orders "A" COMPANY, STAND AT – EASE.

44. After the company has been stood at ease, the company commander will call the master warrant officer forward. On arrival, the master warrant officer shall salute, receive instructions and salute again. The company commander then turns and marches off the parade ground. The master warrant officer shall call the company to attention as the company commander departs. The master warrant officer then carries on as instructed.

COMPANY IN (CLOSE) COLUMN OF PLATOONS FORMING COLUMN OF THREES (COLUMN OF ROUTE)

45. On the command "A" COMPANY, MOVE TO THE RIGHT IN COLUMN OF THREES, RIGHT – TURN:

- a. the company turns right; and
- b. the deputy commander moves to the position for column of threes.

46. After the deputy commander takes up the new position, the leading platoon commander orders NO. 1 PLATOON, BY THE LEFT, QUICK – MARCH (Figure 7-3-7).

47. The platoon commanders of the second and third platoons, in succession, order NO. 2 (3) PLATOON, LEFT WHEEL, BY THE LEFT, QUICK – MARCH. This command is given in time to obtain the correct distance in column of threes. When reaching a position in line with the leading platoon they order NO. 2 (3) PLATOON, RIGHT – WHEEL, and upon the platoon completing the wheel, order BY THE LEFT.

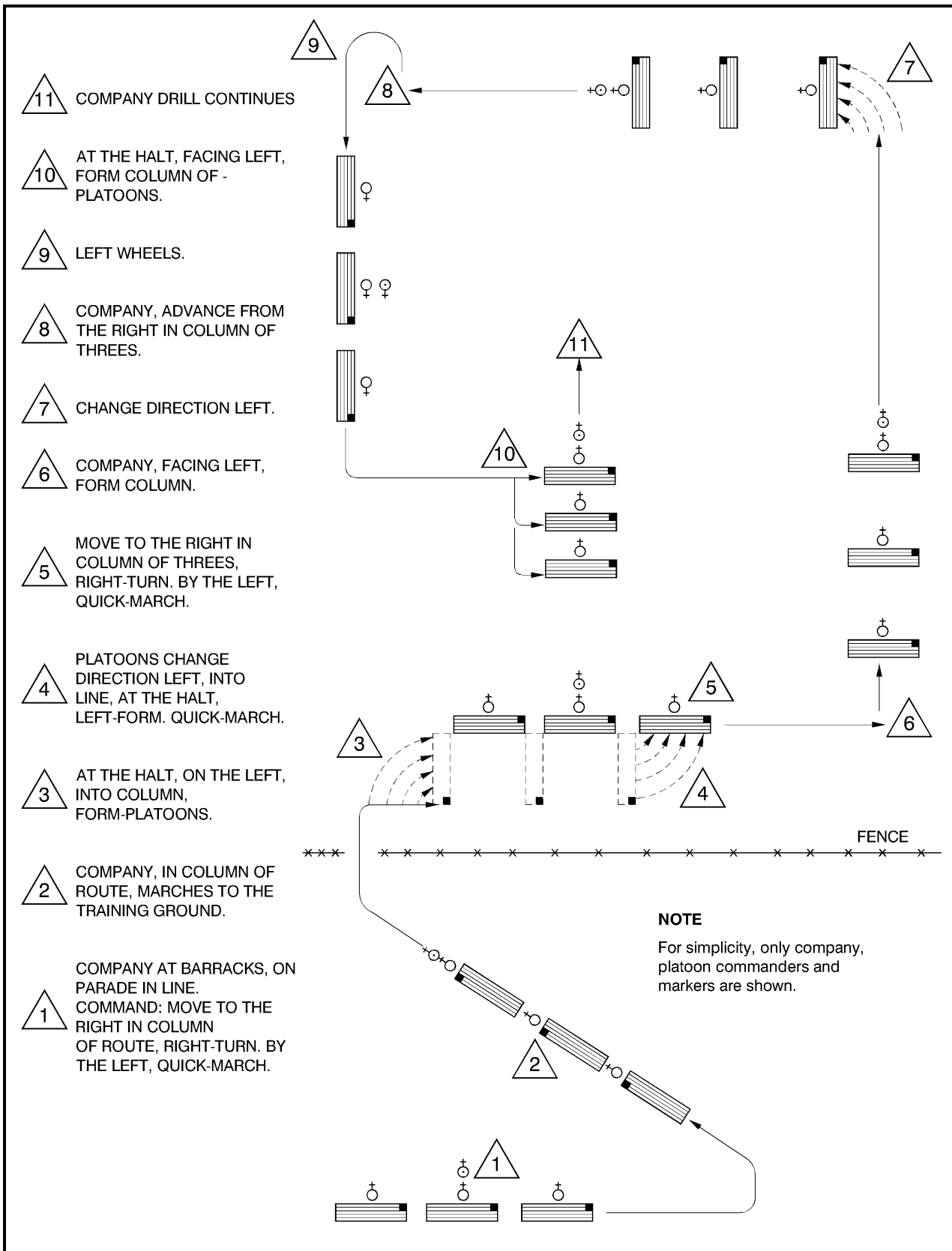

Figure 7-3-7 Company Drill

48. For a company on the march in column of platoons, the command shall be IN SUCCESSION BY PLATOONS, MOVE TO THE RIGHT IN COLUMN OF THREES, after which:

- the leading platoon commander orders NO. 1 PLATOON, RIGHT – TURN;
- the commanders of the second and third platoons order their platoons to turn right when their platoons arrive at the position formerly occupied by the leading platoon when turning; and
- the company deputy commander moves directly to intercept the leading platoon and move to his new position.

49. A company may move to the left in column of threes in a similar manner by exchanging the right and left directions noted above. A company may also be ordered to advance or retire in column of threes from the right or left, platoons wheeling as directed after turning.

50. Similarly, a company may be ordered to move to the right or left IN COLUMN OF ROUTE. When at the halt, the leading platoon commander waits for all officers and warrant officers to take up their new positions before ordering NO. 1 (2) PLATOON, BY THE LEFT (RIGHT), QUICK – MARCH. It is unusual to order a company on the march in column of platoons to move to column of route; if the order is given, officers and warrant officers will double to their new positions.

COMPANY IN COLUMN OF THREES (COLUMN OF ROUTE) FORMING (CLOSE) COLUMN OF PLATOONS AT THE HALT FACING A FLANK

51. On the command “A” COMPANY AT THE HALT, FACING LEFT, FORM (CLOSE) COLUMN OF PLATOONS:

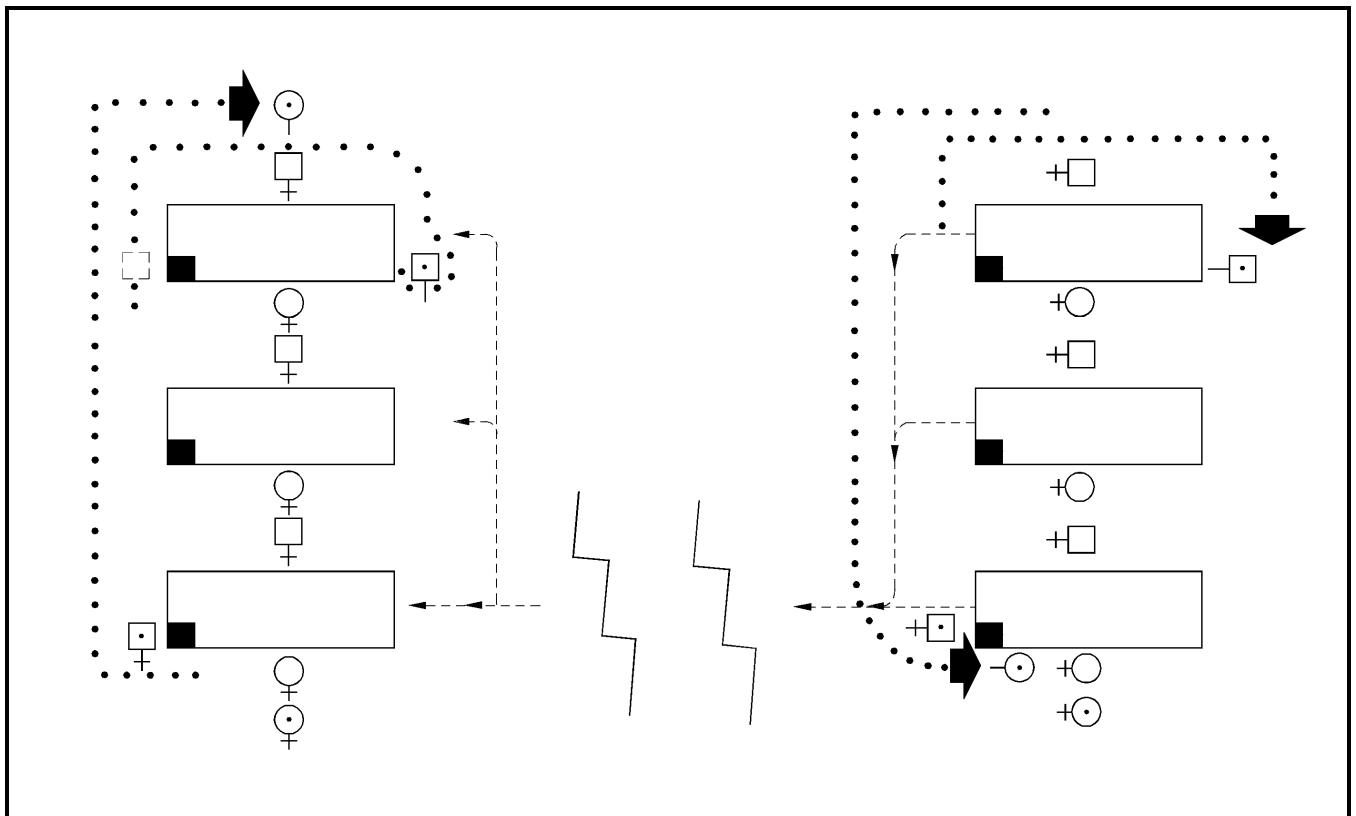

Figure 7-3- 8 Company Drill: Column of Platoons to Column of Threes and Vice Versa

- a. The leading platoon commander orders NO. 1 PLATOON – HALT. Upon completion of the halt, the platoon commander will, if necessary, march to his position in line, and face the platoon.
 - b. The master warrant officer, after halting on the command of the platoon commander, turns right and paces the distance required between No. 1 and No. 2 Platoon and halts.
52. The second platoon commander orders NO. 2 PLATOON, RIGHT – WHEEL, ensuring there is sufficient clearance from the left flank of No. 1 Platoon. The third platoon commander wheels his platoon right on the same ground on which the second platoon wheeled (Figure 7-3-8).
53. When the marker of the second platoon is opposite the master warrant officer, the platoon commander orders NO. 2 PLATOON, LEFT – WHEEL. The platoon is halted one pace short of where the master warrant officer is standing and the platoon commander moves to his position in line if necessary and faces the platoon.
54. After the second platoon halts, the master warrant officer paces to distance required between No. 2 and 3 Platoons and halts. When the marker of No. 3 Platoon is opposite the master warrant officer, the platoon commander orders a LEFT – WHEEL and halts the platoon one pace short of where the master warrant officer is standing. The platoon commander moves to his position in line if necessary and faces the platoon, while the master warrant officer moves to his position for close column of platoons.
55. Once the master warrant officer halts in his position for close column of platoons, the platoon commanders in succession from the front shall order NO. 1 (2) (3) PLATOON ADVANCE, LEFT – TURN. Upon the rear platoon commander’s executive word of command, the three platoon commanders will turn about together.
56. The following personnel will move to their appropriate new locations:
- a. The company commander, upon giving his order to form column of platoons will continue to march forward, halt in time with the leading platoon commander and then move to his new position in the front and centre of the leading platoon, facing the company.
 - b. The deputy commander will halt in conjunction with the leading (in column of threes) or rear (column of route) platoon, march to his right to his new position in column of platoons.
 - c. The warrant officer, after halting and turning left with the rear platoon, will march and, by a series of wheels, proceed around the rear of No. 3 Platoon to his new position in column of platoons.
 - d. The platoon warrant officers will turn left upon their respective platoon commander’s command NO. __ PLATOON ADVANCE, LEFT – TURN.
57. The left and right directions noted above are exchanged if the company is ordered to halt and form column of platoons facing the right.

COMPANY IN CLOSE COLUMN OF PLATOONS FORMING COLUMN OF PLATOONS

58. **At The Halt.** On the command AT THE HALT, ON NO. __ PLATOON, FORM COLUMN:
- a. **To Form Column on the Rear Platoon.** The rear platoon stands fast. The platoons in front are marched by the platoon commanders and halted at the column distance, the master warrant officer having paced the required distance.
 - b. **To Form Column on the Leading Platoon.** The leading platoon stands fast. The remainder about turn, march the column distance, halt, and about turn, the master warrant officer having paced the required distance.

- c. **To Form Column on the Centre Platoon.** The leading platoon is marched by the platoon commander and halted at column distance. The centre platoon stands fast and the rear platoon about turns, marches to column distance, halts, and about turns, the master warrant officer having paced the required distance.
59. **Upon Stepping Off.** On the command “A” COMPANY ADVANCE IN COLUMN:
- a. the leading platoon commander orders NO. 1 PLATOON ADVANCE, BY THE RIGHT, QUICK – MARCH; and
 - b. the platoon commanders in the rear step off their platoons in succession at column distance, in step with the leading platoon.
60. **On the March.** The company can move from close column to column of platoons based on either the rear or leading platoon:
- a. **On the Rear Platoon.** On the command “A” COMPANY, ON NO. 3 PLATOON, FORM COLUMN, REMAINDER, DOUBLE – MARCH, the company will form column on the rear platoon. The platoon commanders of the centre and leading platoon will order CHANGE TO QUICK TIME, QUICK – MARCH, when their platoons are at column distance.
 - b. **On the Leading Platoon.** On the command “A” COMPANY, ON NO. 1 PLATOON, FORM COLUMN, REMAINDER, MARK – TIME, the company will form column on the leading platoon. The platoon commanders of the centre and rear platoons will order FOR – WARD, when their platoons are at column distance.

COMPANY IN COLUMN OF PLATOONS FORMING CLOSE COLUMN OF PLATOONS

61. **At the Halt.** On the command ON NO. ___ PLATOON, FORM CLOSE COLUMN, REMAINDER, QUICK – MARCH, the platoons required to close on the directing platoon are halted by their platoon commanders, when at close column distance. The master warrant officer paces the required distance.
62. **On the March**
- a. On the command ON NO. ___ PLATOON FORM CLOSE COLUMN, REMAINDER DOUBLE – MARCH, the platoons required to close on the designated platoon are given the order, CHANGE TO QUICK TIME, QUICK – MARCH, by their respective platoon commanders, when at close column distance.
 - b. On the command AT THE HALT, FORM CLOSE – COLUMN, the leading platoon commander halts his platoon and the remaining platoon commanders halt their platoons when at close column distance.

COMPANY IN (CLOSE) COLUMN OF PLATOONS AT THE HALT MOVING TO A FLANK IN THREES

63. On the commands “A” COMPANY WILL MOVE TO THE RIGHT IN (CLOSE) COLUMN OF PLATOONS IN THREES, RIGHT – TURN; and “A” COMPANY, QUICK – MARCH, the company turns right and steps off in quick time. The company commander then designates the direction flank.

COMPANY IN COLUMN OF PLATOONS FORMING LINE FACING A FLANK

64. **At the Halt**
- a. On the command PLATOONS CHANGE DIRECTION LEFT, INTO LINE, LEFT – FORM; and QUICK – MARCH, the platoons act as in squad drill. The company marks time until the command FOR – WARD or HALT is given.

- b. On the command PLATOONS, AT THE HALT, CHANGE DIRECTION LEFT, INTO LINE, LEFT – FORM; and QUICK – MARCH, the platoons act as in squad drill, halting when the movement has been completed.

65. **On the March**

- a. On the command PLATOONS, AT THE HALT, CHANGE DIRECTION LEFT, INTO LINE, LEFT – FORM, the platoons act as in squad drill, halting when the movement has been completed.
- b. On the command PLATOONS CHANGE DIRECTION LEFT, INTO LINE, LEFT – FORM, the platoons act as in squad drill. The company marks time until the command FOR – WARD or HALT is given.

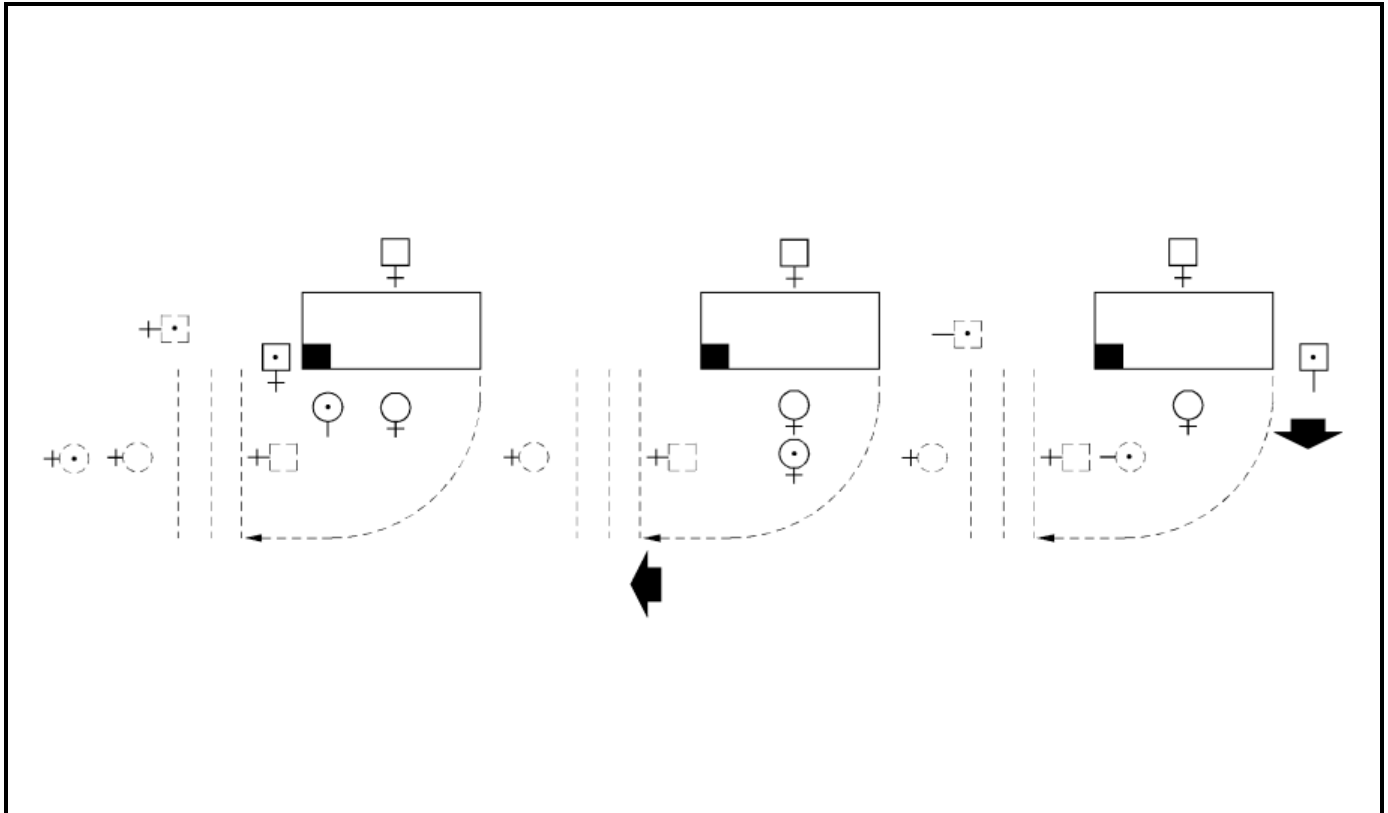

Figure 7-3-9 Company in Line Forming Column of Platoons Facing a Flank

COMPANY IN LINE FORMING COLUMN OF PLATOONS FACING A FLANK

66. **At the Halt**

- a. On the command PLATOONS, AT THE HALT, CHANGE DIRECTION RIGHT, INTO COLUMN, RIGHT FORM; QUICK – MARCH, the platoons act as in squad drill, halting when the movement has been completed (Figure 7-3-9).
- b. On the command PLATOONS, CHANGE DIRECTION RIGHT, INTO COLUMN, RIGHT FORM; QUICK – MARCH, the platoons act as in squad drill. The company marks time until the command FOR – WARD or HALT is given.

67. **On the March**

- a. On the command PLATOONS, AT THE HALT, CHANGE DIRECTION RIGHT, INTO COLUMN, RIGHT – FORM, the platoons act as in squad drill, halting when the movement has been completed.

- b. On the command PLATOONS, CHANGE DIRECTION RIGHT, INTO COLUMN, RIGHT – FORM, the platoons act as in squad drill. The company marks time until the command FOR – WARD or HALT is given.

COMPANY IN COLUMN OF THREES ON THE MARCH FORMING COLUMN OF PLATOONS FACING A FLANK

- 68. On the command “A” COMPANY, FACING LEFT, ADVANCE IN COLUMN:
 - a. the leading platoon commander orders NO. 1 PLATOON, LEFT – TURN; and
 - b. the commanders of the second and third platoons order their platoons to turn left when their platoons arrive at the position formerly occupied by the leading platoon (Figure 7-3-10).
- 69. After each platoon turns, the platoon commander designates the directing flank.
- 70. In conjunction with No. 1 and No. 3 Platoon Commander’s orders, the deputy commander and warrant officer move to their respective positions in column.

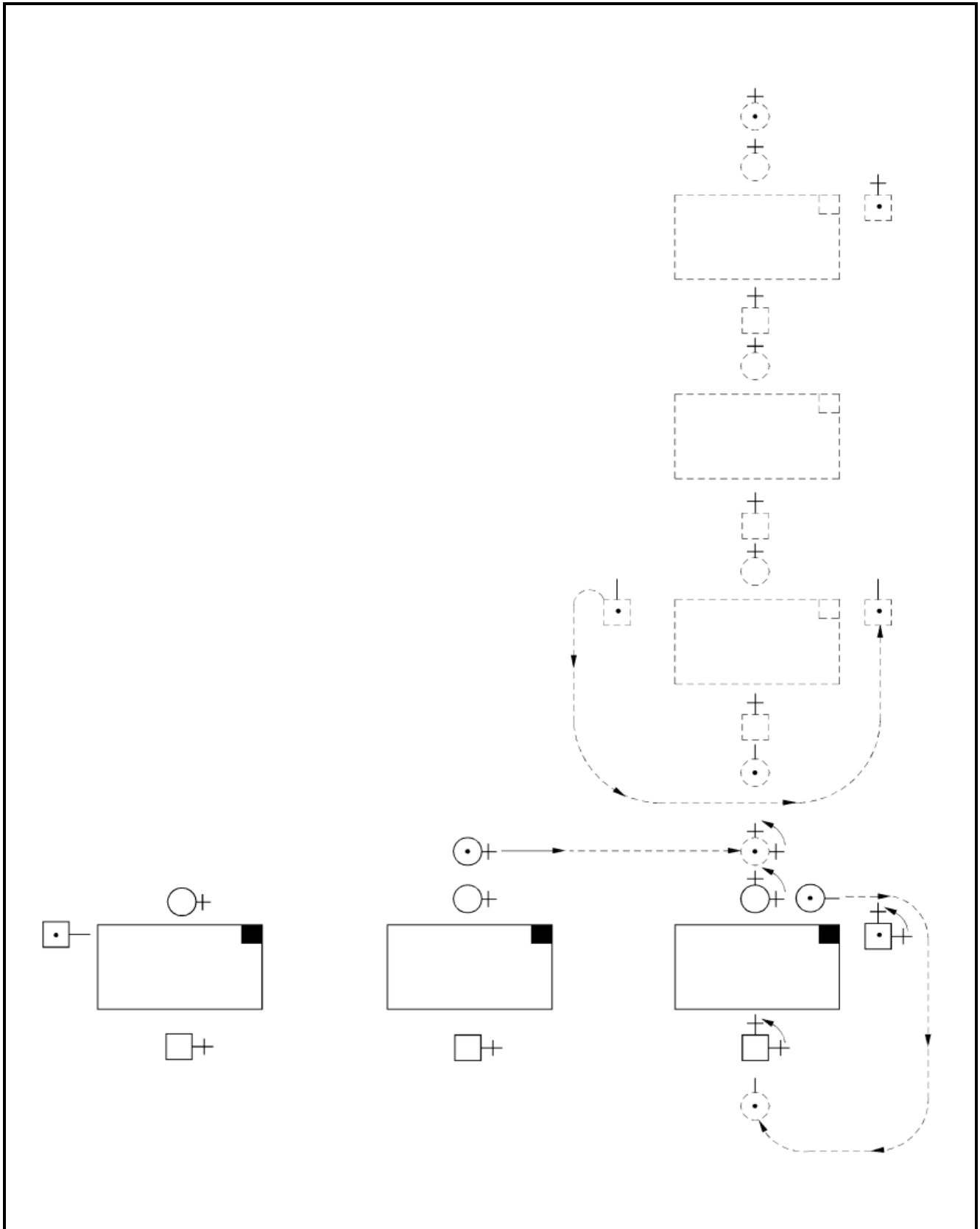

Figure 7-3- 10 Company in Column of Threes On the March Forming Column of Platoons Facing a Flank

COMPANY IN COLUMN OF PLATOONS FORMING LINE FACING THE SAME DIRECTION**71. At the Halt**

- a. On the command AT THE HALT, ON THE LEFT, FORM LINE, REMAINDER LEFT IN – CLINE; QUICK – MARCH:
 - (1) the leading platoon stands fast; and
 - (2) the remainder left incline and then, on the second command, commence marching.
- b. Platoon commanders order RIGHT IN – CLINE as their platoons reach a position opposite their place in line and halt their platoons when they come into position in line.

72. On the March

- a. On the command AT THE HALT, ON THE LEFT, FORM LINE; REMAINDER LEFT IN – CLINE:
 - (1) the leading platoon commander orders HALT; and
 - (2) the remaining platoon commanders order RIGHT IN – CLINE as their platoons reach a position opposite their place in line and halt their platoons when they come into position in line.
- b. If the command AT THE HALT is not given, the leading platoon continues marching in quick time and remainder advance at the double. In this case the order after LEFT IN – CLINE would be RIGHT INCLINE, CHANGE TO DOUBLE TIME, DOUBLE – MARCH. When the second and third platoons reach their positions, the platoon commanders order CHANGE TO QUICK TIME, QUICK – MARCH.

COMPANY IN LINE FORMING (CLOSE) COLUMN OF PLATOONS FACING THE SAME DIRECTION

73. At the Halt. On the command AT THE HALT, ON NO. 1 PLATOON, FORM (CLOSE) COLUMN, REMAINDER, RIGHT TURN; QUICK – MARCH:

- a. the designated platoon stands fast: and
- b. the remainder of the company turns right, steps off in quick time and forms (close) column of platoons to the rear of the designated platoon in the same manner as forming column of platoons from column of threes (see paragraphs 51 to 57).

74. On the March. On the command ADVANCE IN COLUMN, REMAINDER RIGHT – TURN, the right platoon continues to march to its front, the remainder of the company turns right (the company commander moving directly to his new position) and the commanders of the other platoons order LEFT – TURN as their platoons reach their positions in column.

COMPANY IN COLUMN OF PLATOONS MOVING TO A FLANK, FORMING COLUMN OF THREES BY WHEELING

75. On the command ADVANCE IN COLUMN OF THREES, PLATOONS, LEFT – WHEEL, each platoon wheels to the left immediately.

COMPANY IN COLUMN OF THREES FORMING COLUMN OF PLATOONS MOVING TO A FLANK BY WHEELING

76. On the command MOVE TO THE RIGHT IN COLUMN OF PLATOONS, IN THREES, PLATOONS, RIGHT – WHEEL, the platoons wheel immediately.

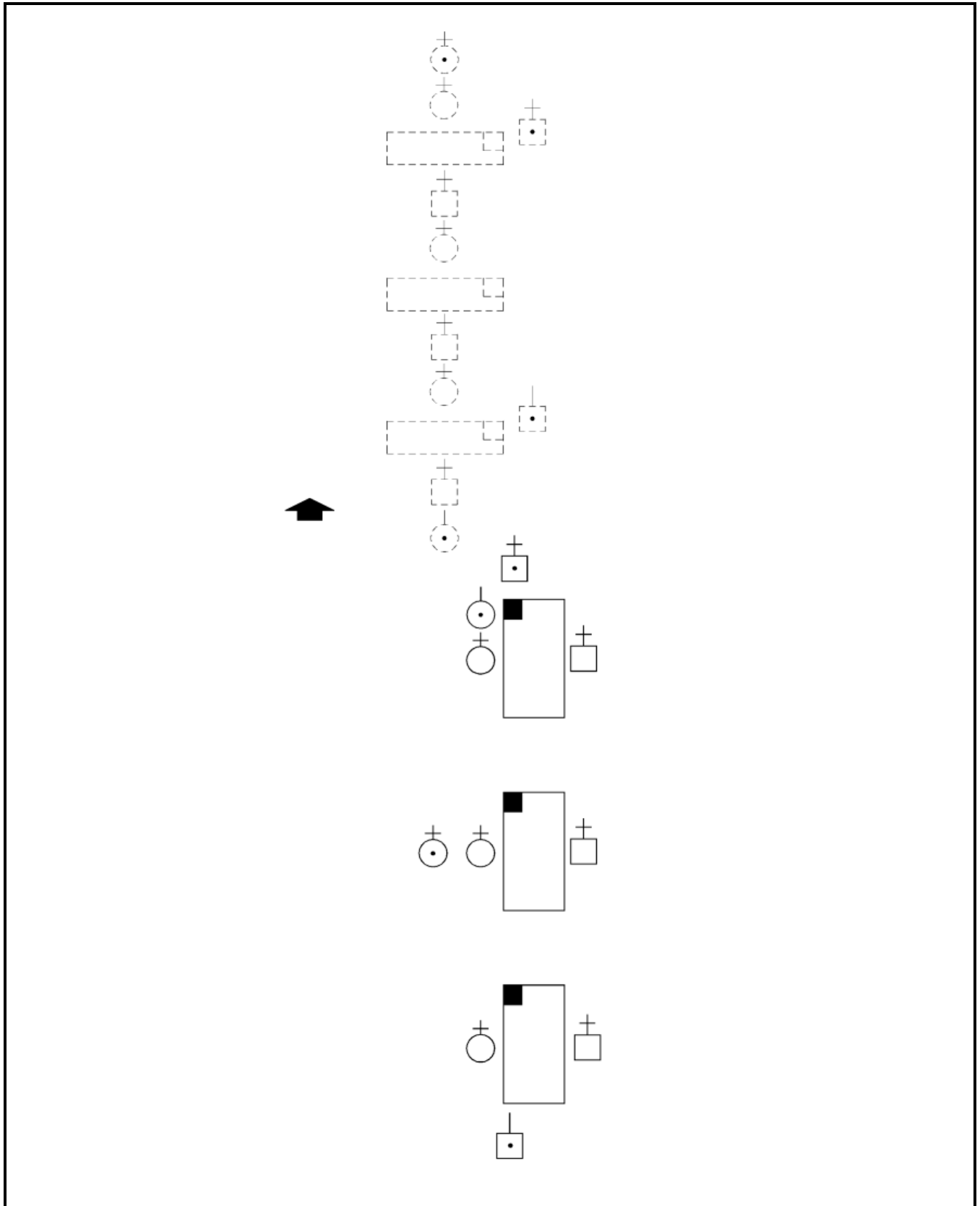

Figure 7-3- 11 Company in Column of Threes Forming Column of Platoons Facing the Same Direction

COMPANY IN COLUMN OF THREES FORMING COLUMN OF PLATOONS FACING THE SAME DIRECTION**77. At the Halt**

- a. On the command AT THE HALT, ON THE LEFT, INTO COLUMN, FORM PLATOONS; QUICK – MARCH, the platoons act as ordered.
- b. The same procedure is used to form close column of platoons with the following exceptions:
 - (1) the company commander shall order ON THE LEFT, INTO CLOSE COLUMN, FORM PLATOONS; QUICK – MARCH;
 - (2) the leading platoon shall act to form platoon normally;
 - (3) as the centre and rear platoons complete the form, the platoon commanders shall order, NO. __ PLATOON, FOR – WARD, and as each platoon arrives at close column distance they shall order, NO. __ PLATOON, MARK – TIME; and
 - (4) the company commander then shall order “A” COMPANY, FOR – WARD or HALT.

78. On the March

- a. On the command ON THE LEFT, INTO COLUMN, FORM – PLATOONS, the platoons act as ordered (Figure 7-3-11).
- b. The same procedure is used to form close column of platoons with the following exceptions:
 - (1) the company commander shall order ON THE LEFT, INTO CLOSE COLUMN, FORM – PLATOONS;
 - (2) the leading platoon shall act to form platoon normally;
 - (3) as the centre and rear platoons complete the form, the platoon commanders shall order, NO. __ PLATOON, FOR – WARD, and as each platoon arrives at close column distance they shall order NO. __ PLATOON, MARK – TIME; and
 - (4) the company commander shall then order “A” COMPANY, FOR – WARD or HALT.

COMPANY IN COLUMN OF PLATOONS CHANGING DIRECTION BY FORMING

79. On the command BY THE RIGHT, CHANGE DIRECTION RIGHT, the leading platoon commander orders NO. 1 PLATOON RIGHT – FORM and then FOR – WARD. The remaining platoons conform on reaching the same ground (Figure 7-3-12).

COMPANY IN CLOSE COLUMN OF PLATOONS ON THE MARCH FORMING LINE FACING A FLANK

80. On the command AT THE HALT, FACING LEFT, FORM – LINE, the rear platoon commander orders NO. 3 PLATOON, LEFT – FORM. The remaining platoon commanders give the same order so as to reach their positions in line.

81. If the cautionary command AT THE HALT is not given, the company marks time until the order FOR – WARD or HALT is given.

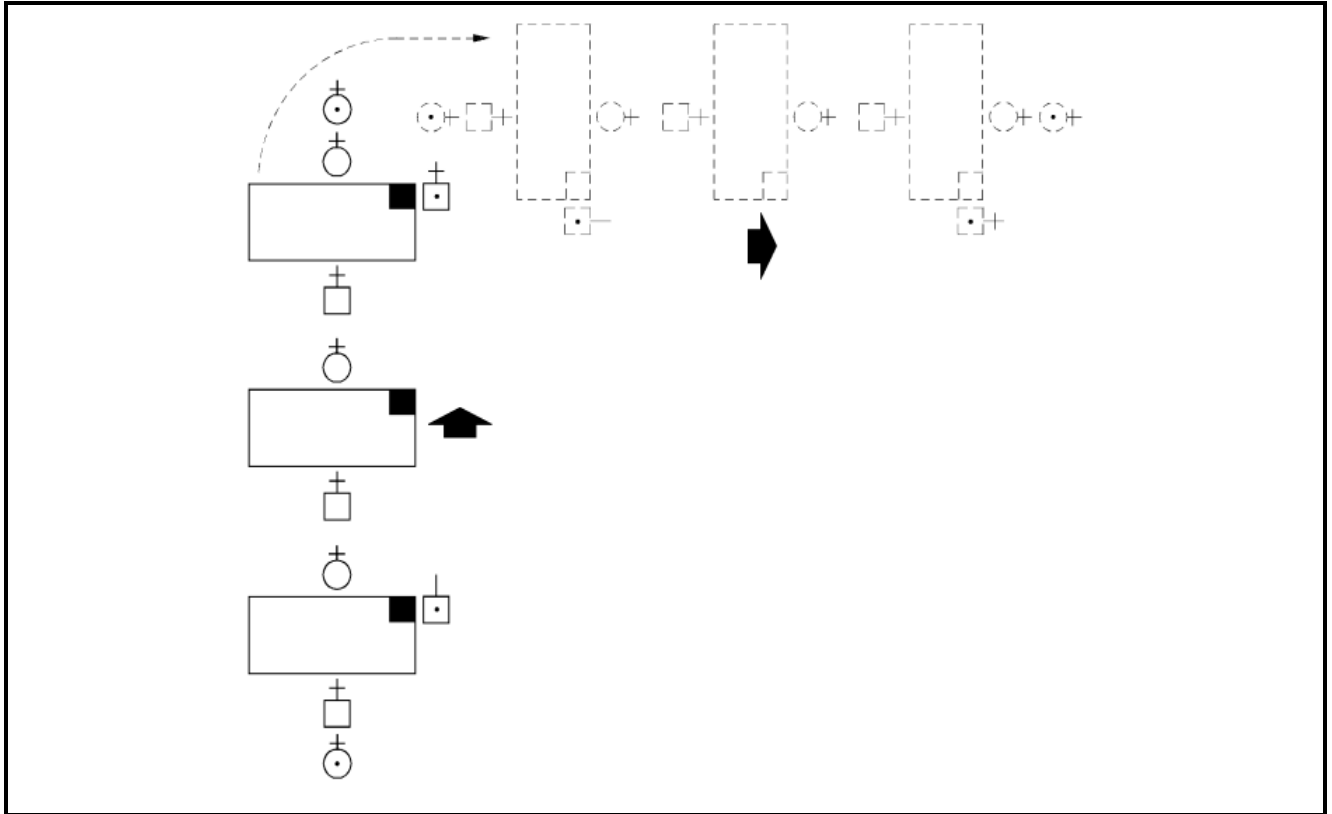

Figure 7-3- 12 Company in Column of Platoons Changing Direction by Forming

COMPANY IN CLOSE COLUMN OF PLATOONS HALTED, FORMING LINE FACING THE SAME DIRECTION

82. On the command ON THE LEFT FORM LINE, REMAINDER LEFT TURN; QUICK – MARCH, the rear platoons wheel right and then left to arrive at their positions in line. Keeping the correct order of platoons, the platoon commanders halt and advance their platoons.

SECTION 4

BATTALION DRILL

INTRODUCTION

1. Detail for exercising a squad, platoon and company with and without arms is applicable to battalion drill.
2. A battalion consists of two or more companies. It is commanded by a commanding officer, assisted by a deputy commander, an adjutant and a chief warrant officer. Their positions on parade are summarized in Figure 7-4-5. Other officers, warrant officers and senior non-commissioned officers not directly involved with the companies shall be supernumeraries and form supernumerary ranks as directed by the commanding officer. For colour bearing units, positions of colours on parade are described and illustrated in Chapter 8, Section 7.
3. The intervals and distances between units and sub-units, may be altered to suit available parade ground space.
4. For simplicity, the battalion described in this section consists of "A", "B" and "C" companies, and its headquarters personnel occupy parade positions or are distributed among the companies on parade. If an actual unit's headquarters is large enough to parade as a separate company, and it is to be maintained as such, it will take post on the right of the line.

BATTALION FORMATIONS

5. **General.** Battalion formations are:
 - a. line;
 - b. column of threes;
 - c. column of route;
 - d. column of companies;
 - e. close column of companies; and
 - f. mass.
6. **Battalion in Line.** When a battalion is formed in line (see Figure 7-4-1):
 - a. the companies are in line, side-by-side on the same alignment, with a 10 pace interval between companies;
 - b. each company is formed in line as in company drill;
 - c. the commanding officer is in the centre of the battalion 15 paces in front of the front rank;
 - d. the deputy commander is in line with the company commanders and six paces in front of the second single file from the left of the left flank platoon of the battalion;
 - e. the adjutant is in line with the company commanders and six paces in front of the second single file from the right of the right flank platoon of the battalion; and
 - f. the chief warrant officer is one pace to the right of the leading company master warrant officer, in line with the front rank.

7. **Battalion in Column of Threes.** A battalion formed in column of threes is in the same formation as when in line, but facing a flank (see Figure 7-4-2).

8. **Battalion in Column of Route.** A battalion in column of route (see Figure 7-4-3) is similar to one in column of threes, except that:

- a. the commanding officer is in the front of the battalion, eight paces in front of the centre single file;
- b. the deputy commander is six paces in rear of the centre single file;
- c. the adjutant is six paces in front of the right single file; and
- d. the chief warrant officer is six paces in front of the left single file.

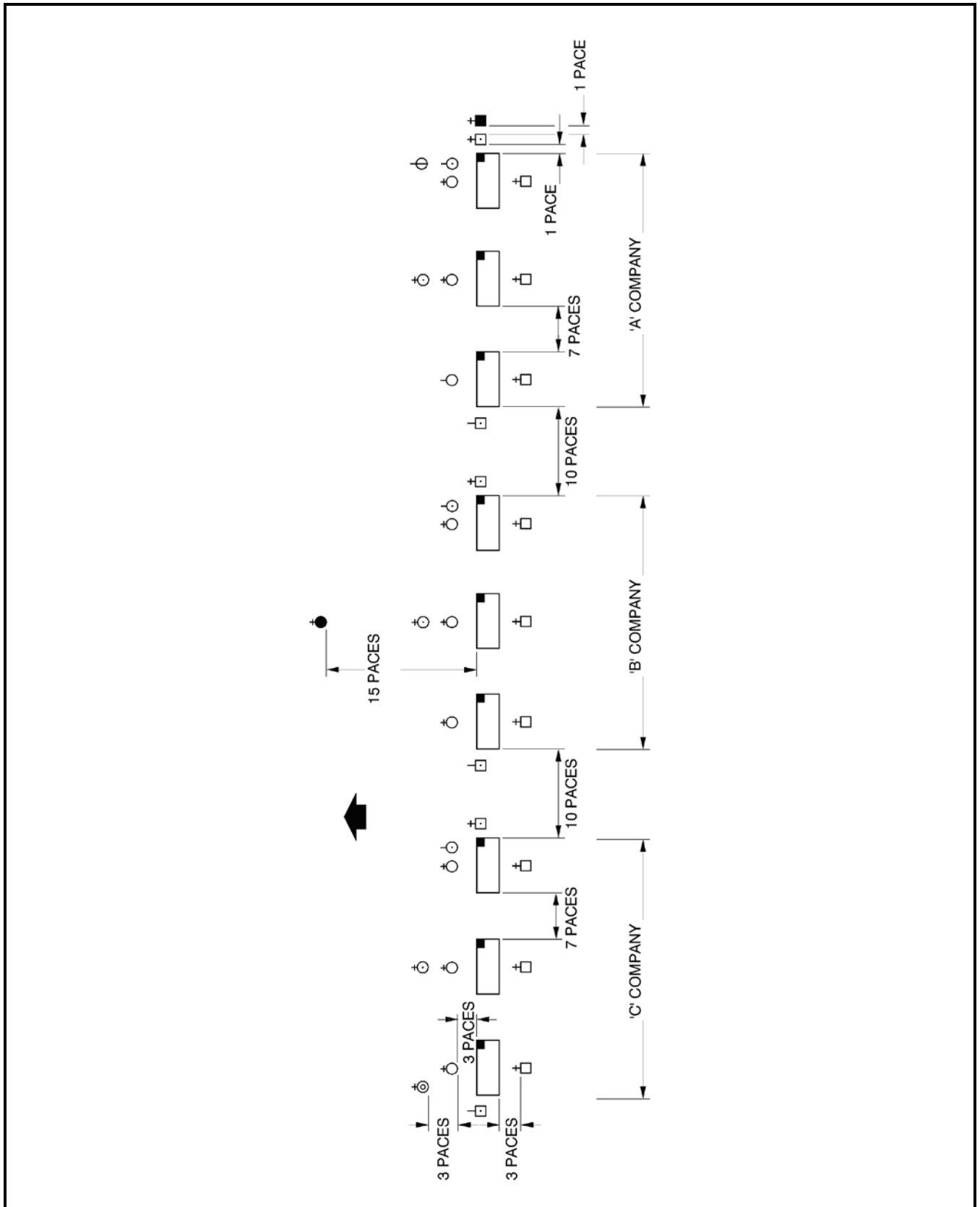

Figure 7-4- 1 Battalion in Lin

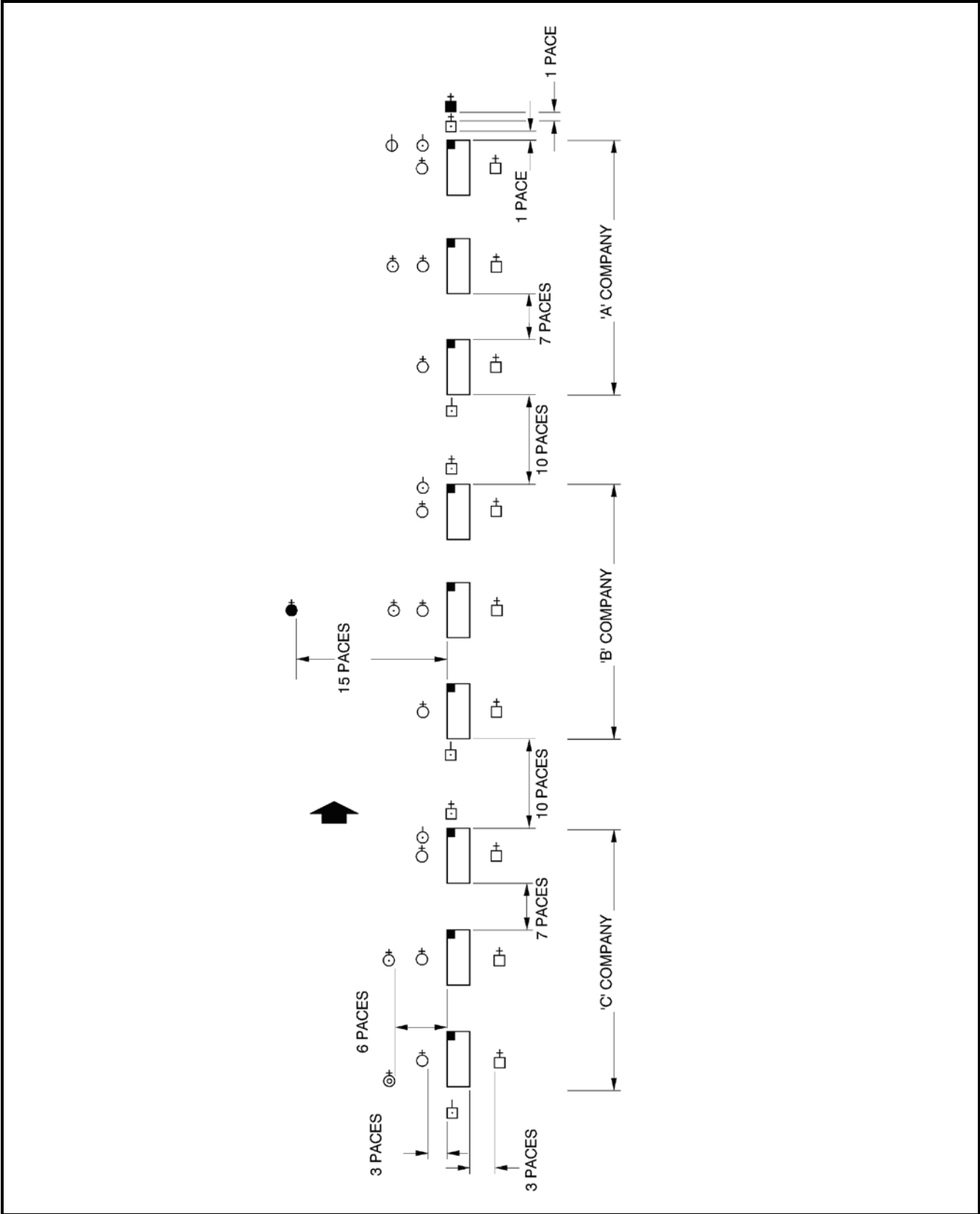

Figure 7-4- 2 Battalion in Column of Threes

9. **Battalion in Column of Companies.** A Battalion in column of companies is formed with each company in line, one behind the other (see Figure 7-4-4). If the companies are of unequal strength, the front company shall be the strongest. The distance between companies is the frontage of the strongest company plus 10 paces. In column of companies:
- a. the commanding officer is 15 paces in front of the front rank and at the centre of the leading company;
 - b. the deputy commander is six paces in front of the second single file from the left of the left flank platoon of the front company of the battalion;
 - c. the adjutant is six paces in front of the second single file from the right, of the right flank platoon of the front company of the battalion; and
 - d. the chief warrant officer is one pace to the right of the leading company master warrant officer, in line with the front rank.
10. **Battalion in Close Column of Companies.** A battalion formed in close column of companies maintains the same formation in all detail as for column of companies (see Figure 7-4-4) except that:
- a. the distance between companies may be reduced to suit the circumstances, but remains the same between each company; and
 - b. the minimum distance between companies is 15 paces.
11. **Battalion in Mass.** When a battalion is in mass (Figure 7-4-5):
- a. the companies are formed in close column of platoons on the same alignment;
 - b. there is a 10-pace interval between companies;
 - c. the commanding officer is in the centre of the battalion, 15 paces in front of the front rank of the battalion;

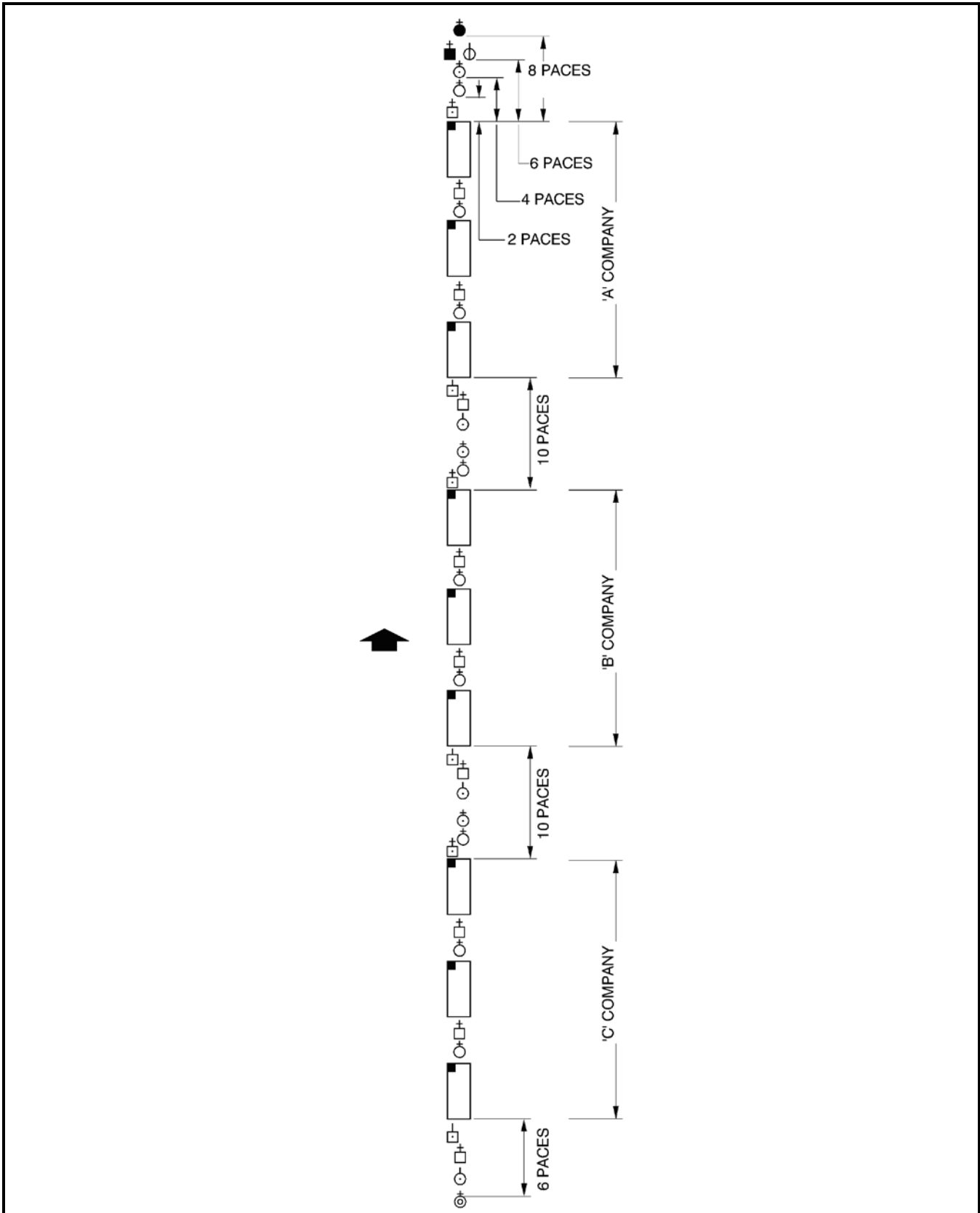

Figure 7-4- 3 Battalion in Column of Route

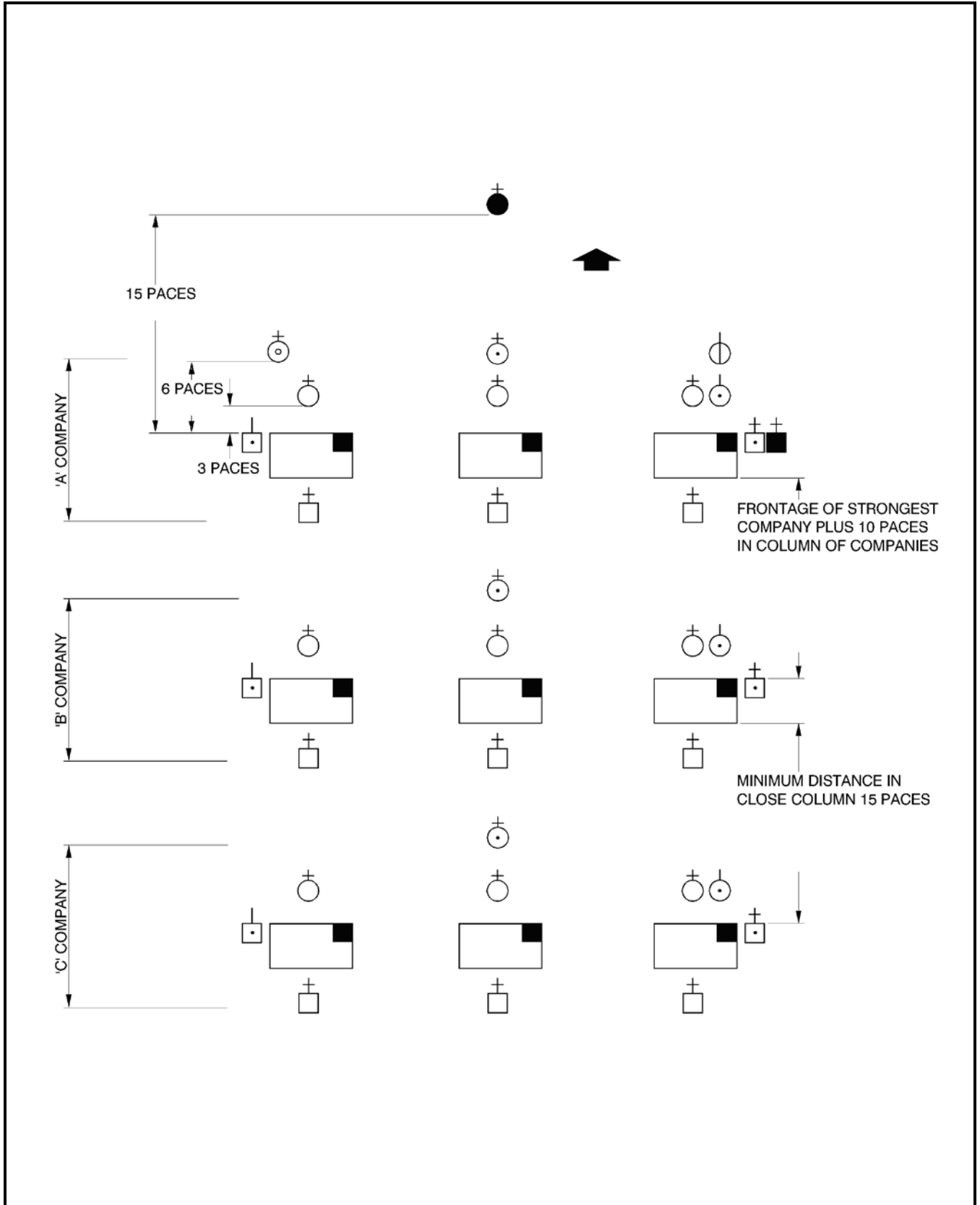

Figure 7-4- 4 Battalion in Column (Close Column) of Companies

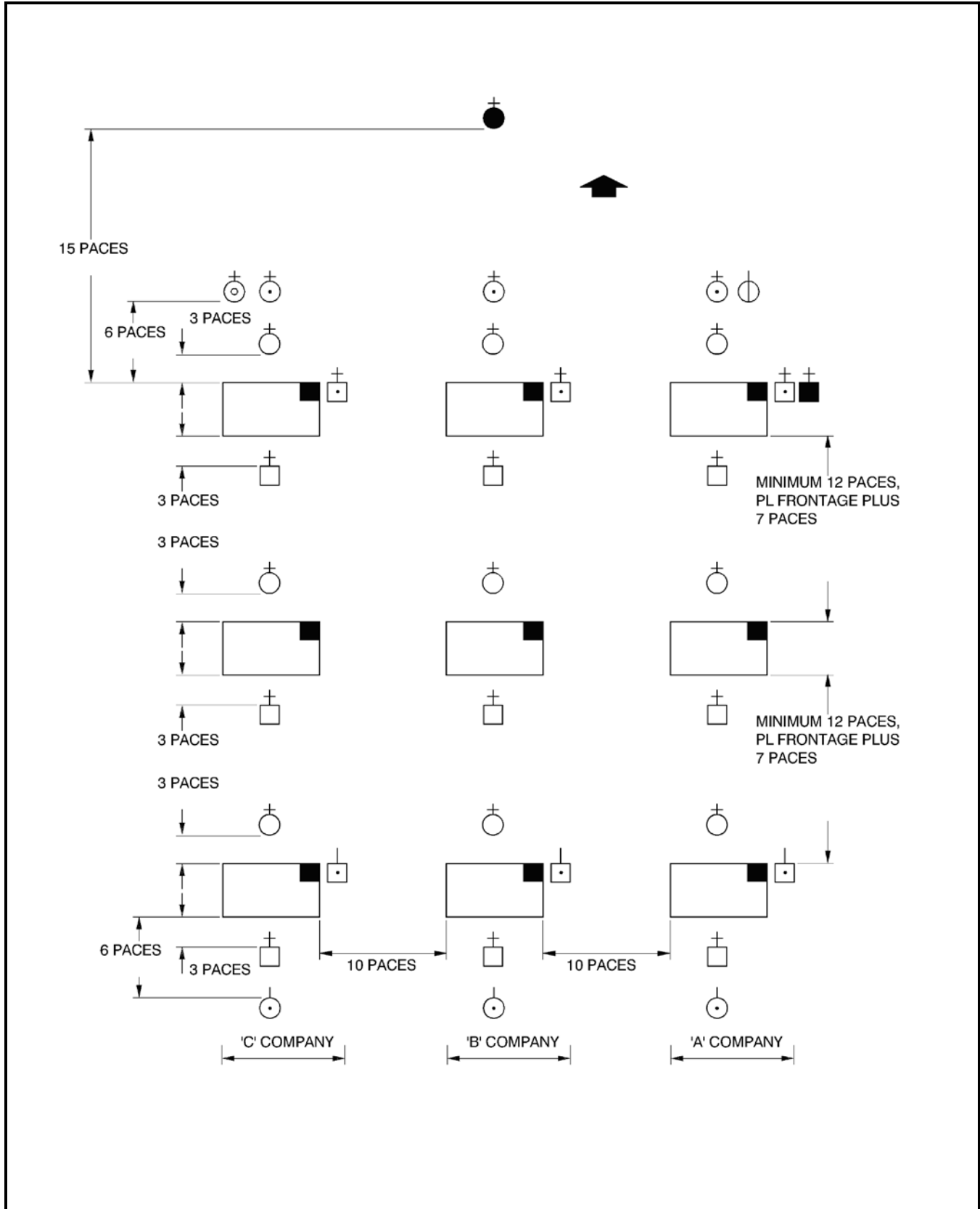

Figure 7-4- 5 Battalion in Mass

- d. the deputy commander is six paces in front of the second single file from the left of the front platoon of the left flank company;
- e. the adjutant is six paces in front of the second single file from the right of the front platoon of the right flank company; and
- f. the chief warrant officer is one pace to the right of the leading company master warrant officer, in line with the front rank.

TELLING OFF A BATTALION

12. When troops do not parade together regularly, it may be necessary to organize and identify companies and platoons. The troops will be assembled in groups, often after being sized.

13. If the groups are platoons or platoon-sized units, the chief warrant officer shall assemble them in a convenient order and command TELL OFF BY PLATOONS. The platoon warrant officers shall call out their number in succession as noted in Section 3, paragraph 12. The chief warrant officer then orders:

- a. 1, 2 AND 3 PLATOONS SHALL FORM "A" COMPANY; and
- b. 4, 5 AND 6 PLATOONS SHALL FORM "B" COMPANY, etc.

14. If the groups are companies or company-sized units, the chief warrant officer will command TELL OFF BY COMPANIES and the master warrant officer's shall reply in succession:

- a. "A" COMPANY;
- b. "B"; and
- c. "C" COMPANY.

15. Only the first and last companies shall be identified by use of the word "company", thus indicating that all companies have answered the order.

16. The chief warrant officer then confirms these designations by ordering "A", "B" and "C" COMPANIES WILL FORM THE BATTALION.

DRESSING A BATTALION IN LINE

17. At the completion of all battalion drill movements, when a battalion is halted in line, the battalion shall be dressed.

18. On the command RIGHT – DRESS by the commanding officer:

- a. all officers turn about;
- b. the battalion deputy commander and the company commanders dress on the adjutant;
- c. the platoon commanders, company deputy commanders and supernumerary officers dress on the company deputy commander of "A" Company;
- d. the platoon warrant officers, supernumerary warrant officers and non-commissioned officers dress on the warrant officer or non-commissioned officers on the right flank, who looks to the front;

- e. the members in the ranks dress by the right, while the file on the right flank looks to the front;
 - f. the chief warrant officer turns right and marches five paces to the right of the battalion, about turns and dresses each rank in succession in a similar manner to dressing a platoon as detailed in Section 2, paragraph 10; and
 - g. when the chief warrant officer orders REAR RANK – STEADY, the commanding officer orders BATTALION, EYES – FRONT.
19. On the command BATTALION, EYES – FRONT:
- a. officers about turn;
 - b. the chief warrant officer returns to his original position; and
 - c. the remainder of the battalion act as ordered.
20. If it is necessary to have the interval between platoons and companies paced off, it shall be done by the master warrant officers of “B” and “C” companies.
21. When the chief warrant officer is in charge of the battalion and orders RIGHT – DRESS, the master warrant officer of the right flank company will carry out the instructions detailed for the chief warrant officer above.

DRESSING A BATTALION IN COLUMN AND CLOSE COLUMN OF COMPANIES

22. At the completion of all battalion drill movements, when a battalion is halted in column and close column of companies, the battalion shall be dressed.
23. On the command RIGHT – DRESS, by the commanding officer:
- a. all officers about turn, and the battalion deputy commander and the “A” company commander dress on the adjutant;
 - b. the remainder act as for company drill; and
 - c. the chief warrant officer marches forward to a position six paces in front of the right hand marker of the leading company, halts, about turns, and ensures that the right hand file of each company is covered correctly and then orders RIGHT FLANK – STEADY.
24. On the command RIGHT FLANK – STEADY, the master warrant officers dress their companies normally. When the dressing has been completed the master warrant officers shall, in succession, order ___ COMPANY, REAR RANK – STEADY.
25. After the master warrant officer of the rear company orders REAR RANK – STEADY, the commanding officer orders BATTALION, EYES FRONT.
26. On the command BATTALION, EYES – FRONT:
- a. all officers about turn;
 - b. the chief warrant officer returns to his original position;
 - c. the master warrant officers return to their original positions; and
 - d. the remainder of the battalion acts as ordered.

27. If it is necessary to have the interval between platoons paced off, it shall be done by the platoon warrant officers of the second and third platoon of each company.

28. When the chief warrant officer is in charge of the battalion and orders RIGHT – DRESS, the master warrant officer of the front company will carry out the duties of the chief warrant officer and the No. 1 Platoon warrant officer will carry out the duties of the front company master warrant officer.

DRESSING A BATTALION IN MASS

29. At the completion of all battalion drill movements, when a battalion is halted in mass, the battalion shall be dressed.

30. On the command RIGHT – DRESS by the commanding officer:

- a. all officers about turn, dressing on the officers on the right flank;
- b. the platoon warrant officer and supernumerary warrant officers and non-commissioned officers dress on the non-commissioned officers on the right flank, who look straight to the front;
- c. the members in the ranks dress by the right, with the file on the right flank looking straight to the front;
- d. the chief warrant officer marches to a position six paces in front of and facing the right front marker and dresses the right flank of the battalion;
- e. the platoon warrant officers of the right hand company take up normal positions six paces to the right of their front ranks as for platoon drill and dress the battalion after the chief warrant officer has given the command RIGHT FLANK – STEADY;
- f. the platoon warrant officers order each rank STEADY in succession from the front before moving as a group, acting on the rear platoon warrant officer's order of STEADY, to the next rank; and
- g. after the rear platoon warrant officer orders REAR RANK – STEADY, the commanding officer orders BATTALION, EYES – FRONT.

31. On the command BATTALION, EYES – FRONT:

- a. all officers about turn;
- b. the chief warrant officer and the platoon warrant officers return to their original positions; and
- c. the remainder of the battalion acts as ordered.

32. If it is necessary to have the interval between companies paced off, it shall be done by the master warrant officers of "B" and "C" Companies.

33. When the chief warrant officer is in charge of the battalion and orders RIGHT – DRESS, the master warrant officer of the right flank company will carry out the duties of the chief warrant officer.

FORMING UP A BATTALION

34. Prior to a battalion parade, the companies are formed in their company area by their master warrant officer. The master warrant officers ensure that the platoon warrant officers call the roll, size and inspect their respective platoons. The strength of the platoons is reported to the master warrant officers.

35. Company markers will report to the chief warrant officer at the edge of the parade grounds, opposite the position they will occupy when fallen in. Markers shall know the frontage of their leading (largest) platoon.

36. The battalion may be formed up in mass, line or (close) column of companies.

37. The words of command and the action taken to form a battalion in mass are detailed in Table 7-4-1.

No.	Command	By	Action	Remarks
1			CWO marches to and halts three paces in front of the position to be occupied by the "A" Coy marker.	Companies are formed in a designated area, standing easy. The CWO shall face the future position of the front rank if the battalion is to form up in line or mass, and the right flank if the battalion is to form up in (close) column of companies.
2	MARKERS	CWO	The company markers come to attention, shoulder arms, and march onto the parade ground. The leading company marker halts three paces in front of and facing the CWO. The remainder halt and dress on the left of that marker at shoulder dressing. Upon completion of dressing, they look to the front in succession from the right. The markers remain at the shoulder arms.	Companies adopt the stand at ease position. Standard pauses are observed between drill movements. Note: On ceremonial occasions, the CWO may order or signal a bugler to sound MARKERS. The company markers act on the last note, or on an executive "G" note, depending on unit custom.
3	MARKERS – NUMBER	CWO	The markers number consecutively from right to left.	
4	NO. 1 RIGHT, REMAINDER LEFT – TURN	CWO	"A" Company marker turns right, the remainder turn left.	The CWO specifies the number of paces to be taken by each marker.
5	NO. 1 STAND FAST, REMAINDER QUICK – MARCH	CWO	"A" Company marker stands fast, the remainder march the required distance and halt.	
6	NO. 1 STAND FAST, REMAINDER ABOUT – TURN	CWO	"A" Company marker stands fast, the remainder about turn and cover off the "A" Company marker.	The CWO marches out six paces in front of "A" Company marker, halts, turns about and ensure the markers are covered off.
7	MARKERS – STEADY	CWO	The markers stand fast.	If the battalion is being formed in line or mass, the CWO shall proceed as detailed in No. 7a. If in (close) column, the CWO turns right and marches to a position 15 paces in front and centre of where the battalion will be formed. The CWO then proceeds as detailed in No. 8.

Table 7-4-1 (Sheet 1 of 4) Forming Up a Battalion

No.	Command	By	Action	Remarks
7a	MARKERS, LEFT – TURN	CWO	The markers turn left.	This order places the markers in line. The CWO marches to a position 15 paces in front and centre of where the battalion will be formed.
8	BATTALION, FALL – IN	CWO	Each company MWO comes to attention and turns about to face his company.	Note: On ceremonial occasions, the CWO may order or signal bugler to sound ADVANCE. Company MWOs act on the last note, or on an executive “G” note, depending on unit custom.
9	__ COMPANY, ATTEN – TION	MWO	The company acts as ordered.	The company commands are given by each MWO consecutively.
10	__ COMPANY, SHOULDER – ARMS	MWO	The company acts as ordered.	
11	__ COMPANY, MOVE TO THE RIGHT IN COLUMN OF THREES, RIGHT – TURN	MWO	The company acts as ordered.	
12	__ COMPANY, QUICK – MARCH	MWO	The company acts as ordered.	Where required, commands for wheeling will be given to bring the company to its marker. If the battalion is being formed in line or column of companies, each company will be halted on its marker, and the MWOs will act as detailed in No. 13. If the battalion is being formed in mass, each company will be manoeuvred to bring its lead platoon in line with its marker from the left, and the MWOs will act as detailed in No. 14.
13	__ COMPANY, HALT	MWO	The company acts as ordered.	Officers may begin promenading.
13a	__ COMPANY, ADVANCE, LEFT (RIGHT) – TURN	MWO	The company acts as ordered.	Companies are advanced consecutively from the right (front). On the last company MWO’s word of command, MWOs turn about simultaneously to face the front. The CWO then proceeds as detailed in No. 15.

Table 7-4-1 (Sheet 2 of 4) Forming Up a Battalion

No.	Command	By	Action	Remarks
14	___ COMPANY, AT THE HALT, FACING LEFT, FORM COLUMN (CLOSE COLUMN) OF PLATOONS	MWO	The company acts as ordered, the platoon WOs halting their platoons in column of platoons. The MWO marches off the required distance between each platoon as for dressing the company.	Officers may begin promenading.
14a	NO. 1 PLATOON, ADVANCE, LEFT – TURN	No. 1 PL WO	No. 1 Platoon acts as ordered, the platoon WO remains facing his platoon.	Each platoon in the company acts in sequence. The MWO and the platoon WOs, acting on the executive command TURN by the rear platoon WO, turn about together to face the front. The sequence is repeated by successive companies. After the last company's non-commissioned officers are facing the front, the CWO proceeds as detailed in No. 15.
15	BATTALION, ORDER – ARMS	CWO	The battalion acts as ordered.	
16	BATTALION, OPEN ORDER – MARCH	CWO	The battalion acts as ordered.	
17	BATTALION, RIGHT – DRESS	CWO	The battalion acts as ordered.	The MWOs of “B” and “C” Companies pace off the interval between companies once the front rank of the platoon to their right stands firm, and then return to their original positions.
18	BATTALION, EYES – FRONT	CWO	The battalion acts as ordered.	
19	REPORT YOUR COMPANIES	CWO	The MWOs report the strength of their companies consecutively from the right.	The MWO will state “___ Company, ___ all ranks on parade, Sir” when reporting or according to unit custom. The battalion deputy commander (DComd) moves to a position two paces in rear of the CWO at the end of this segment, while the other officers position themselves in line five paces in rear of the DComd, facing their respective companies, ready to fall in.

Table 7-4-1 (Sheet 3 of 4) Forming Up a Battalion

No.	Command	By	Action	Remarks
20			The CWO turns about, salutes, and reports the battalion to the DComd. The DComd orders the CWO to fall in. The CWO salutes, turns right, and marches to his position on parade. The DComd takes two paces forward to assume the CWO's former position.	The DComd shall wait until the CWO has adopted his new position before giving any further commands. It is common for the DComd to exercise the battalion by ordering it to stand at ease and then back to attention before proceeding to No. 21.
21	OFFICERS, FALL – IN	DComd	Officers will act as ordered, as for company drill.	MWOs and platoon WOs will report their sub-units to their officers and, after being ordered to fall in, march to their new positions. Once the platoon WO has adopted his new position, the platoon commander will turn about facing the front.
22	COMPANY, STAND AT EASE	Coy Comd	The company acts as ordered.	Given consecutively from the right front by each company commander (Coy Comd). Upon the last Coy Comd giving the command, all Coy Comds turn about and stand at ease together. The battalion is now ready, at the appointed time, to receive its commander. The CO marches on the parade ground and adopts a position two paces in rear of the DComd. The DComd turns about and calls the battalion to attention as the CO approaches.
23	BATTALION, ATTEN – TION	DComd	The DComd salutes and reports the battalion to its CO; the CO orders the DComd to fall in. The DComd salutes, turns left, and marches to his position on parade. The CO steps forward to assume the DComd's former position.	The CO shall wait until the DComd is in position before giving further orders.
24	BATTALION, STAND AT EASE	CO	The battalion acts as ordered.	The CO then carries on by inspecting the battalion, having subordinate commanders inspect their own sub-units, or proceeding with training or ceremonial.

Table 7-4-1 (Sheet 4 of 4) Forming Up a Battalion

FALLING OUT THE OFFICERS

38. Prior to giving the order to officers to fall out, the commanding officer positions himself so that the officers may halt at the required distance in front of him, with sufficient space left for the master warrant officers to occupy the positions vacated by the company commanders.
39. The command OFFICERS FALL – OUT is given by the commanding officer when the battalion is at attention.
40. The officers march by the most direct route and form up in a line, five paces in front of, centred on and facing the commanding officer, at arm's length interval (without raising the arm), the deputy commander on the right.
41. When all officers are present, the deputy commander shall take a half pace forward. As his right foot completed the movement, all officers will observe a standard pause and salute. After the commanding officer has finished speaking to them, they shall salute together and march five paces behind, halt in line, turn about return swords and stand at ease. When ordered by the commanding officer to DIS – MISS, the deputy commander shall step back one half pace. All officers will observe the standard pause, salute with the hand and march straight off the parade ground.
42. On the command OFFICERS FALL – OUT, the master warrant officer and the platoon warrant officers, if armed, shall shoulder arms and then march to the positions vacated by the company and platoon commanders, the platoon warrant officers moving around the left flank of their respective platoons. Upon arrival in the new position, all order arms.
43. After dismissing the officers, the commanding officer orders the battalion to STAND AT – EASE.
44. After standing the battalion at ease, the commanding officer calls the chief warrant officer forward. On arrival, the chief warrant officer shall salute, receive instructions and salute again. The commanding officer then turns and marches off the parade ground. The chief warrant officer shall call the battalion to attention as the commanding officer departs. The chief warrant officer then carries on as instructed.

BATTALION IN MASS MOVING OFF IN COLUMN OF THREES (COLUMN OF ROUTE)

45. The battalion may be ordered to advance, retire or move to a flank in column of threes or column of route.
46. To advance (retire) in column of threes:
- The commanding officer orders ADVANCE (RETIRE) FROM THE RIGHT (LEFT), IN COLUMN OF THREES, __ COMPANY LEADING, RIGHT (LEFT) – TURN. The battalion acts as ordered.
 - The leading platoon commander of the leading company orders NO. __ PLATOON, LEFT (RIGHT) WHEEL BY THE LEFT (RIGHT), QUICK – MARCH. The remaining platoon commanders give appropriate orders to enable their platoons to follow the route taken by the first platoon of the leading company.
47. To move to a flank in column of threes:
- The commanding officer shall order MOVE TO THE RIGHT (LEFT) IN COLUMN OF THREES, __ COMPANY LEADING, RIGHT (LEFT) – TURN.
 - The battalion acts as ordered. Upon executing the right (left) turn, the leading platoon commander shall order, NO. __ PLATOON BY THE RIGHT (LEFT), QUICK – MARCH. The remaining platoon commanders give appropriate orders to enable their platoons to follow the route taken by the first platoon.
48. Similar commands are given to advance, retire or move to a flank in column of route. The leading platoon commander shall wait for all appointments to assume their positions in column of route before giving orders. The remaining platoon commanders give appropriate orders to enable their platoons to follow the route taken by the first platoon.

BATTALION IN COLUMN OF THREES OR COLUMN OF ROUTE FORMING MASS

49. The commanding officer orders ON ___ COMPANY, FORM – MASS. The company designated shall be the leading company.

50. The company commander of the leading company orders AT THE HALT, FACING LEFT, FORM CLOSE COLUMN OF PLATOONS. The company acts as ordered.

51. The remaining company commanders give the same order in time to enable their companies to form close column of platoons at an interval of 10 paces to the left of the leading company.

BATTALION IN (CLOSE) COLUMN OF COMPANIES MOVING OFF IN COLUMN OF THREES (COLUMN OF ROUTE)

52. The battalion may be ordered to advance, retire or move to a flank in column of threes or column of route.

53. To advance (retire) in column of threes:

- a. The commanding officer orders ADVANCE (RETIRE), FROM THE RIGHT (LEFT), IN COLUMN OF THREES, ___ COMPANY LEADING, RIGHT (LEFT) – TURN. The battalion acts as ordered.
- b. The company commander of the leading company orders ___ COMPANY, LEFT (RIGHT) WHEEL, BY THE LEFT (RIGHT), QUICK MARCH. The remaining company commanders shall give appropriate orders for their companies to gain their correct positions in column of threes.

54. To move to a flank in column of threes:

- a. The commanding officer shall order MOVE TO THE RIGHT (LEFT) IN COLUMN OF THREES, ___ COMPANY LEADING, RIGHT (LEFT) – TURN. The battalion acts as ordered.
- b. Upon executing the right (left) turn, the company commander of the leading company shall order ___ COMPANY, BY THE RIGHT (LEFT), QUICK – MARCH. The remaining company commanders shall give the appropriate order to follow the route taken by the leading company.

55. Similar commands are given to advance, retire or move to a flank in column of route. The leading company commander shall wait for all appointments to assume their positions in column of route before giving his orders. The remaining company commanders give appropriate orders to gain their correct positions in column of route.

BATTALION IN COLUMN OF THREES OR COLUMN OF ROUTE FORMING CLOSE COLUMN OF COMPANIES AT THE HALT FACING A FLANK

56. The commanding officer orders AT THE HALT, FACING LEFT (RIGHT), FORM CLOSE COLUMN OF COMPANIES.

57. The company commanders give orders as for platoon orders (Section 3, paragraphs 51 to 56).

BATTALION IN COLUMN OF THREES OR COLUMN OF ROUTE FORMING CLOSE COLUMN OF COMPANIES AT THE HALT FACING THE SAME DIRECTION

58. The commanding officer orders AT THE HALT, FACING LEFT, FORM CLOSE COLUMN OF COMPANIES.

59. The companies act as do platoons in company drill (Section 3, paragraph 78).

CHAPTER 8
COLOURS AND FLAGS
SECTION 1
GENERAL

DEFINITIONS

1. **Cased Colours.** Colours enclosed in a fabric case.
2. **Colours.** Consecrated ceremonial flags which are carried by, and mark the identity of, Canadian Armed Forces (CAF) formations and units, and include: Queen's Colours; Standards; Guidons; and Command, College and Regimental Colours.
3. **Dipping the Colours.** Rendering a salute by lowering the Colours to the entitled dignitaries detailed in A-AD-200-000/AG-000, Honours, Flags and The Heritage Structure of the Canadian Forces (soon to become A-DH-200-000/AG-000; The Heritage Structure of the CAF).
4. **Flags.** Pieces of bunting or other material, attachable to a staff or halyard, and used as a means of identification or for signalling. As a generic term, it includes Colours. In this chapter it specifically means only those non-consecrated flags which may be carried on parade, i.e., Commemorative (Royal) banners, the National Flag, the CAF Ensign and Command Flags. Commemorative (Royal) Banners are not paired or grouped with other flags and are not dipped in a salute. Branch and Unit camp Flags are strictly marker flags and are not carried on parades A-AD-200-000/AG-000, Honours, Flags and The Heritage Structure of the Canadian Forces (soon to become A-DH-200-000/AG-000; The Heritage Structure of the CAF, Chapter 4, sections 6 & 7).
5. **Let Fly the Colours.** Releasing the Colours to fly free, either as a salute to dignitaries not entitled to the Royal Salute as detailed in A-AD-200-000/AG-000, Honours, Flags and The Heritage Structure of the Canadian Forces (soon to become A-DH-200-000/AG-000; The Heritage Structure of the CAF), or to allow free identification of the flag.
6. **Uncased Colours.** Colours removed from the fabric case.

PARADING COLOURS AND FLAGS

7. Guidelines for when Colours and flags may be carried on parade are given in A-AD-200-000/AG-000, Honours, Flags and The Heritage Structure of the Canadian Forces soon to become A-DH-200-000/AG-000; The Heritage Structure of the CAF.
8. The Colour drill in this chapter applies equally to flags when carried on parade, unless specifically noted.

DRAPING THE COLOURS

9. Colours only shall be draped for funerals (see Chapter 11). The Colour is draped with a piece of black crepe 2.5 m long and 33 cm wide, tied in a bow at the base of the pike head so that the span of the bow is 30 cm. The ends, cut on the bias, should hang half-way down the sleeve of the Colour (Figure 8-1-1).

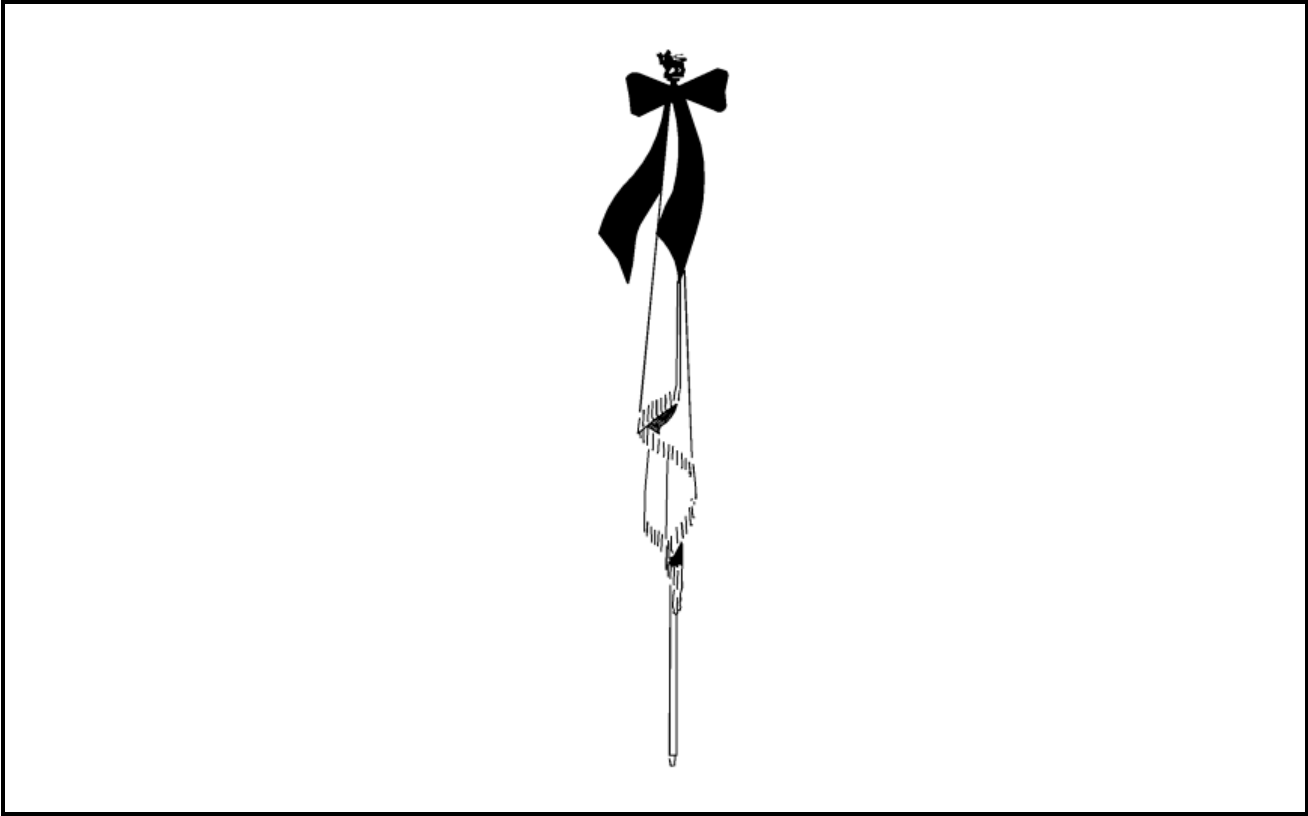

Figure 8-1- 1 Draping the Colour

SECTION 2

THE COLOUR PARTY

COMPOSITION OF A COLOUR PARTY

1. The composition of a Colour Party carrying one Colour (Figure 8-2-1) shall be:
 - a. Colour Officer – one junior officer (a Guidon is carried by a master warrant officer); and
 - b. Colour Escorts – two sergeants (or below, if necessary).
2. The composition of a Colour party carrying two Colours (Figure 8-2-2) shall be:
 - a. Colour officers – two junior officers; and
 - b. Colour Escorts – one master warrant officer or warrant officer, and two sergeants (or below, if necessary).
3. Colour parties are attended by Colour Orderly (corporal, drummer or private) for each Colour carried. Orderlies (not integral to the Colour Party or escort) usually march in supernumerary ranks of near (parade formations) sub-units until needed to attend the Colours, or wait off parade as required. See paragraph 11.
4. When a stand of Colours is carried, the Queen's Colour occupies the position of honour, i.e., on the right of the Colour party (on the left from the spectators point of view).

NOTE;

In RMC the composition of a **colour party** shall be all cadet officers.

COMPOSITION OF A FLAG PARTY

5. When the National Flag, Canadian Armed Forces (CAF) Ensign or command flags are carried on parade, they shall normally be carried by senior non-commissioned officers.
6. Normally, the National Flag has no escort. It may be given an armed escort if the troops on parade are armed. When paraded at multinational sporting and cultural events where other nations have an armed escort in their flag party, the composition of the Canadian flag party shall include an armed escort.
7. The CAF Ensign and command flags by themselves are not entitled to, and shall not be attended by, an armed escort. They may have such an escort when paraded in company with the National Flag if it has an armed escort.
8. When a flag party carries the National Flag and either the CAF Ensign or a command flag, the National Flag occupies the position of honour on the right (on the left from the spectators point of view).

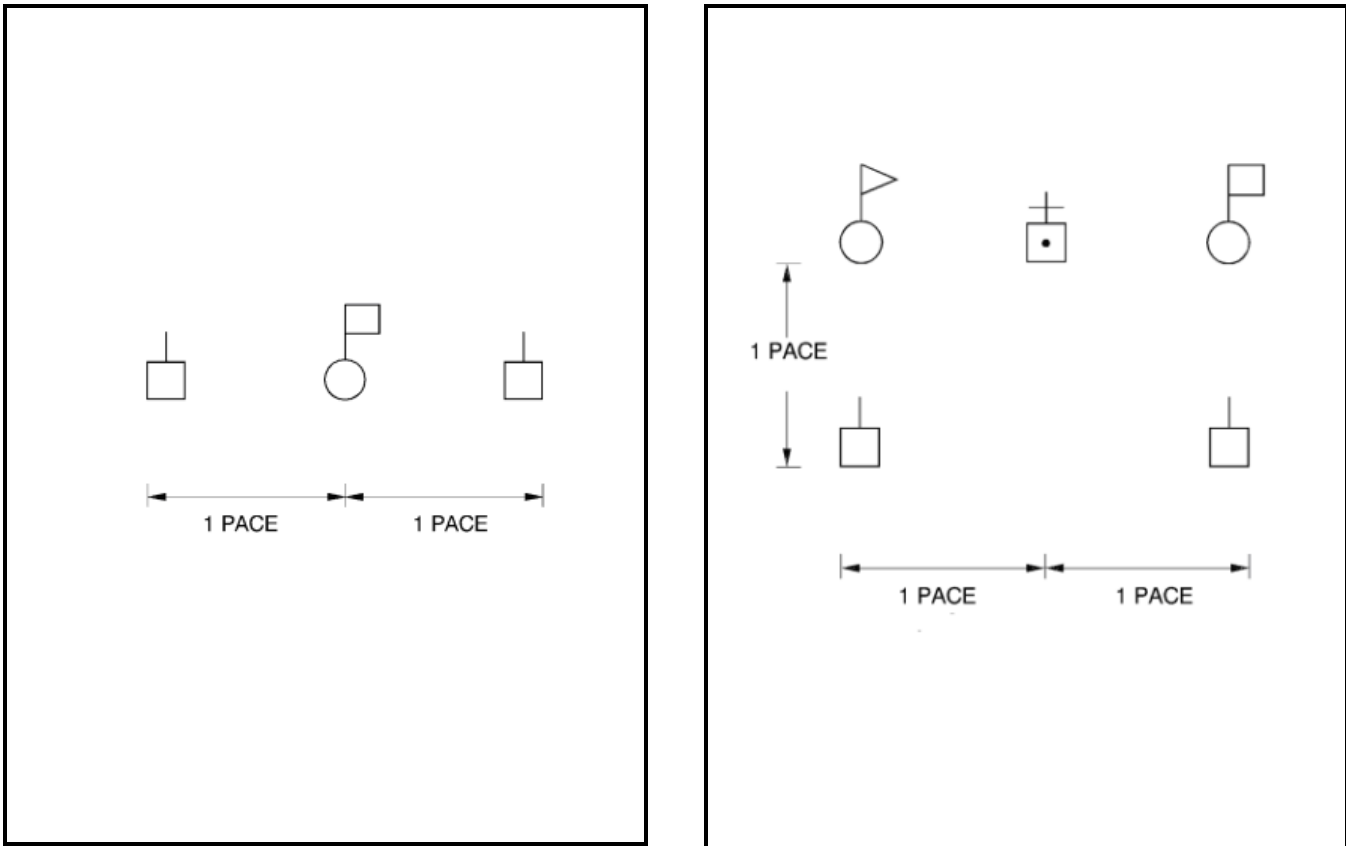

Figure 8-2- 1 Colour Party for One Colour

DUTIES

9. **Colour Officers (master warrant officer for Guidons).** Colour officers are appointed to carry, handle and protect the Colours.

10. **Colour Escort.** The mission of Colour escorts is to safeguard the Colours. Once they have taken up their duty, they remain with the Colour, or with any armed “escort to the Colour”, until it is safely lodged again. With an “escort to the Colour”, they occupy supernumerary positions until called upon to resume their close escort duties. When Colours are ordered to take post in review order, the escorts shall stand fast.

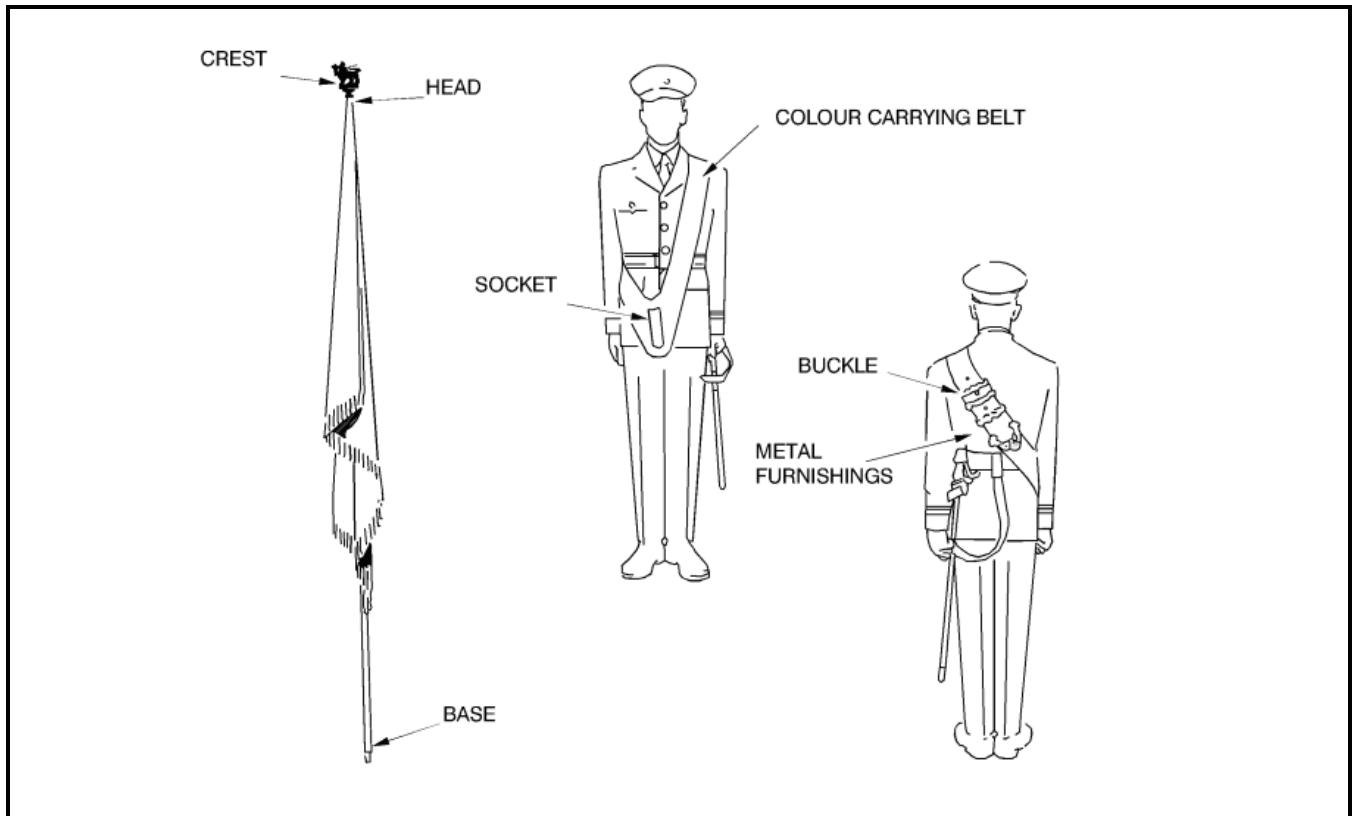

Figure 8-2- 2 Details of the Colour Pike and Belt

11. **Colour Orderlies.** When Colours are to be moved cased to a ceremonial parade, a Colour orderly shall be designated for each to assist the Colour officer and take charge of the cases during the parade. In units with a corps of drums, a drummer or bugler is traditionally given this responsibility, with the drum major assisting the adjutant with ensuring that Colours and Colour belts are ready for parades. Since a drummer or bugler with Colour orderly duties is precluded from playing an instrument, any other service member may be selected in lieu.

ARMS AND EQUIPMENT

12. The details of the Colour pike and belt are shown in Figure 8-2-3.
13. The Colour bearer wears the Colour belt over the left shoulder.
14. The Colour officer (or master warrant officer in the case of armoured regiments) shall be armed with a sword or a pistol.
15. The Colour escort shall be armed with bayonets fixed, the points of which may be covered with short sheathes, in order to avoid tearing the Colours.
16. Colour Party members when in charge of Colours do not remove headdress, nor do they unfix bayonets or remove swords (see Chapter 2, paragraph 23.)

SECTION 3

COLOUR DRILL

GENERAL

1. Colour drill shall be executed with a standard pause between movements in a similar manner to rifle drill.
2. A cased Colour shall be held in the order position at the halt and carried in the slope position on the march. A cased Colour is never held at the carry.
3. An uncased Colour is never sloped at the halt; it shall be at the carry or the order, according to whether arms are at the shoulder or the order.
4. On the march, an uncased Colour always shall be carried at the slope, except when on the review parade ground or when paying compliments. Then, it shall be at the carry.
5. During an inspection of personnel on parade the uncased Colour shall be at the carry.

POSITION OF THE ORDER

6. At the order (Figure 8-3-1):
 - a. The Colour bearer is at attention.
 - b. The pike is held vertical with the right hand, at the right side. The base of the pike is on the ground at the right side of the right foot, in line with the toe of the shoe.
 - c. The pike and Colour are held with an all-round grasp of the right hand, back of the hand outwards, at the point of the pike where the lowest corner of the Colour reaches.
 - d. The Colour shall hang naturally down the pike and shall not be stretched taut.
 - e. The right elbow is at the side.
 - f. The right wrist is directly in rear of the pike.
 - g. A cased Colour is held similarly except that the case is grasped in the right hand.

STAND AT EASE FROM THE ORDER

7. On the command STAND AT – EASE:
 - a. move the left foot in the normal manner (Figure 8-3-2); and
 - b. keep the Colour and pike unmoved in the same position as described for the order.

STAND EASY FROM STAND AT EASE

8. On the command STAND – EASY:
 - a. the Colour and pike remain in the same position;
 - b. the left arm is kept to the side; and

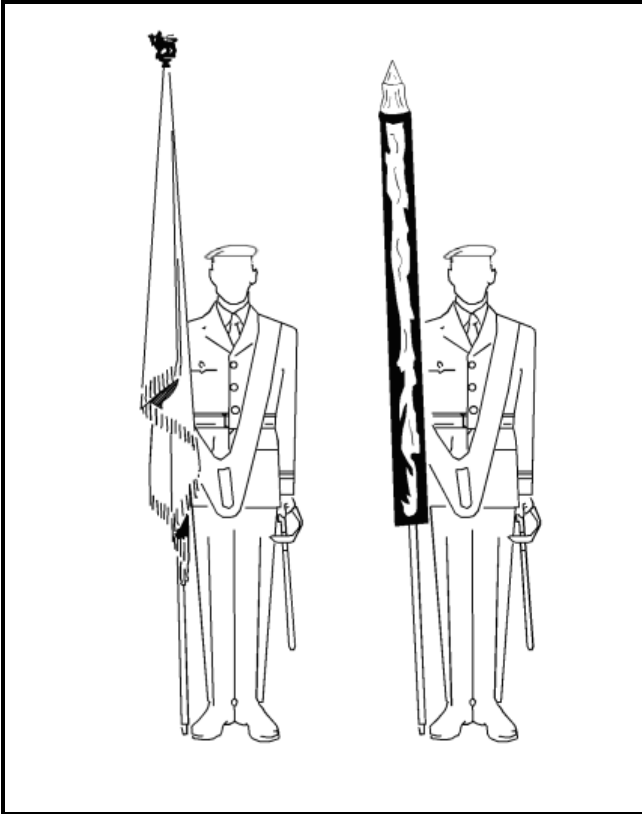

Figure 8-3-1 Position of the Order (uncased and cased)

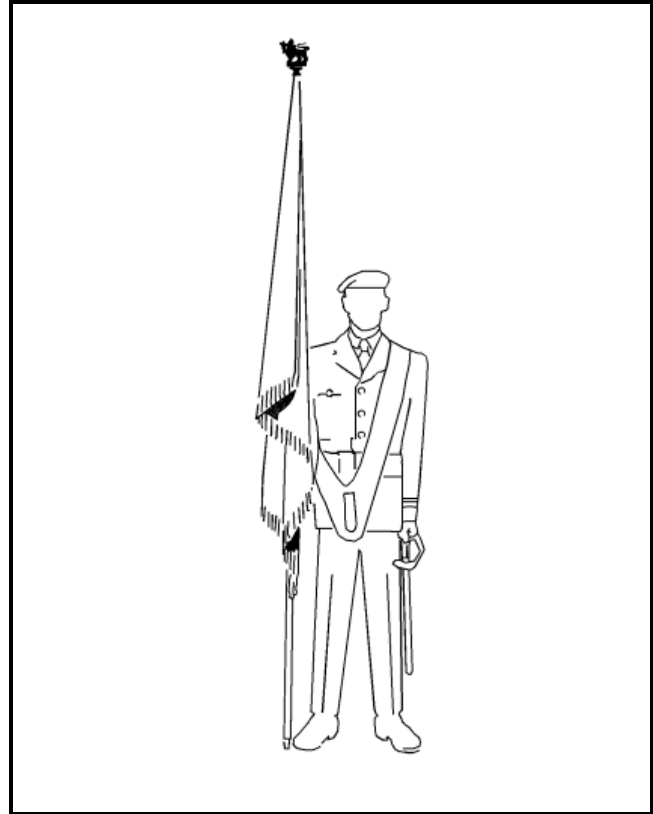

Figure 8-3-2 Stand at Ease

- c. the body is relaxed, but the feet and Colour are not moved.

9. The stand at ease position shall be resumed on the cautionary command SQUAD (GUARD) (etc.). The Colour Party never stands easy while in charge of Colours

10. DELETED

ORDER FROM STAND AT EASE

- 11. On the command ATTENTION, move the left foot in the normal manner.

CARRY FROM THE ORDER

- 12. On the command CARRY COLOUR(S) BY NUMBERS, SQUAD – ONE;

- a. with the right hand, raise the Colour to a vertical position in front of the centre of the body, keeping the base of the pike just clear of the socket, and the right forearm alongside the pike (Figure 8-3-3); and
- b. simultaneously, bring the left hand to the socket and guide the pike into the socket.

- 13. On the command SQUAD – TWO:

- a. bring the left hand to the position of the order;
- b. simultaneously raise the right forearm parallel to the ground; thus

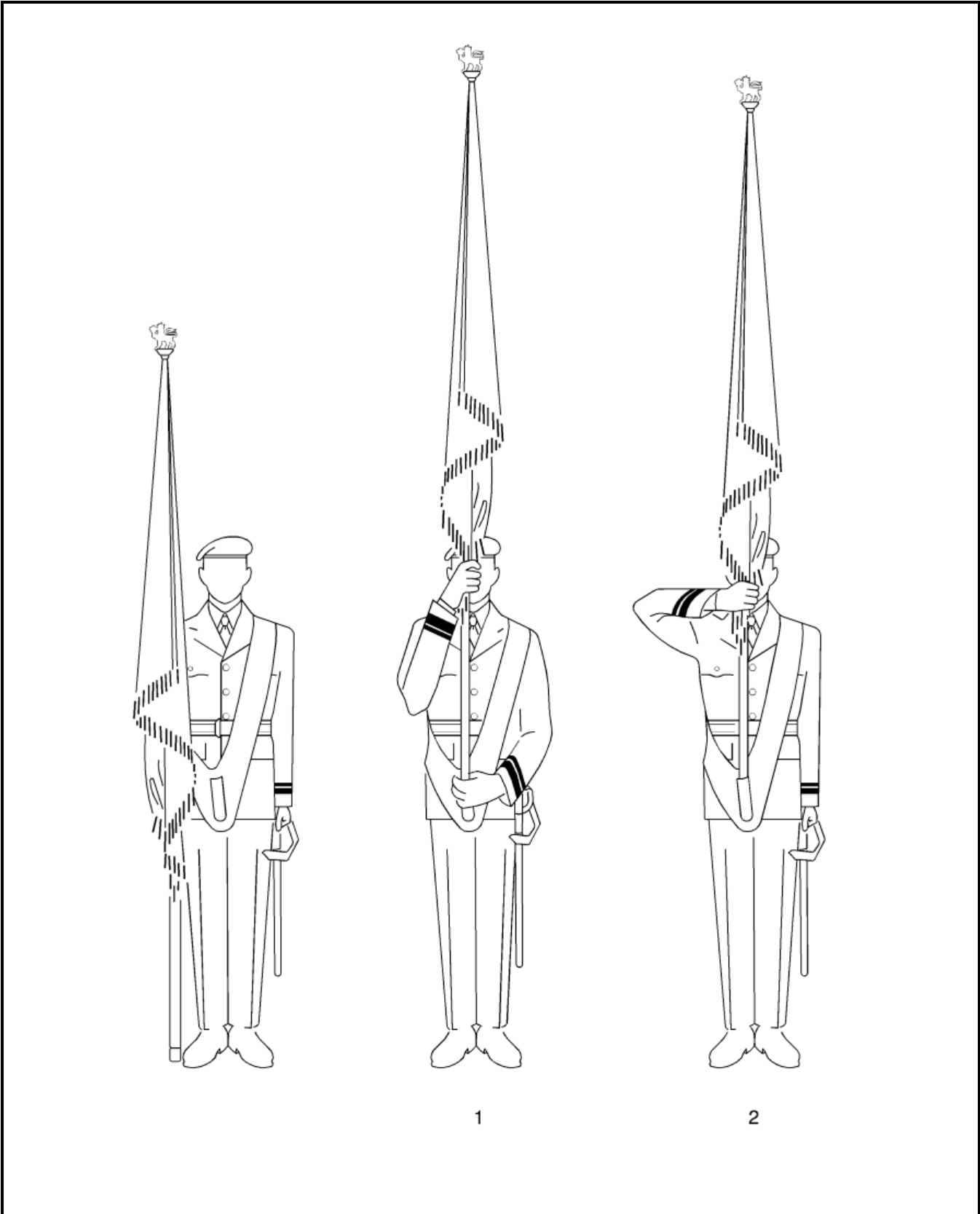

Figure 8-3-3 Carry from the Order

- c. on completion of the movement:
 - (1) the right hand is opposite the mouth,
 - (2) the right forearm is parallel to the ground at right angles to the pike,
 - (3) the wrist of the right arm is straight,
 - (4) the back of the hand is outwards, and
 - (5) the head and eyes are facing the front.

14. On the command CARRY – COLOUR, the two movements are combined. A standard pause shall be observed between the movements.

15. When arms are carried on a parade and the parade is given the command SHOULDER – ARMS, the Colour officer shall carry the Colour in time with the rifle movements.

ORDER FROM THE CARRY

16. On the command ORDER COLOUR(S) BY NUMBERS, SQUAD – ONE:

- a. with the right hand raise the pike clear of the socket, bringing the right forearm from the horizontal position to a vertical position alongside the pike (Figure 8-3-4); and
- b. simultaneously, bring the left hand to the socket to steady the pike and belt.

17. On the command SQUAD – TWO:

- a. carry the Colour with the right hand to the position of the order;
- b. move the left hand across the body to steady the pike; thus

c. on completion of the movement:

- (1) the back of the left hand shall be outwards,
- (2) the fingers of the left hand are extended and pointing to the right, and
- (3) the left forearm is parallel to the ground.

18. On the command SQUAD – THREE, cut the left hand to the side in the position of attention.

19. On the command ORDER – COLOUR, the three movements are combined. A standard pause shall be observed between the movements.

20. When arms are carried on a parade and the parade is given the command ORDER – ARMS, the Colour officer shall order the Colour in time with the rifle movements, unless the command is given just prior to an inspection, when the Colour officer shall remain at the carry.

SLOPE FROM THE CARRY

21. Colours are never held at the carry when cased. Colours are sloped only when on the march (cased or uncased). For the purposes of initial instruction, positions shall be taught at the halt. On the command SLOPE COLOUR(S) BY NUMBERS, SQUAD – ONE:

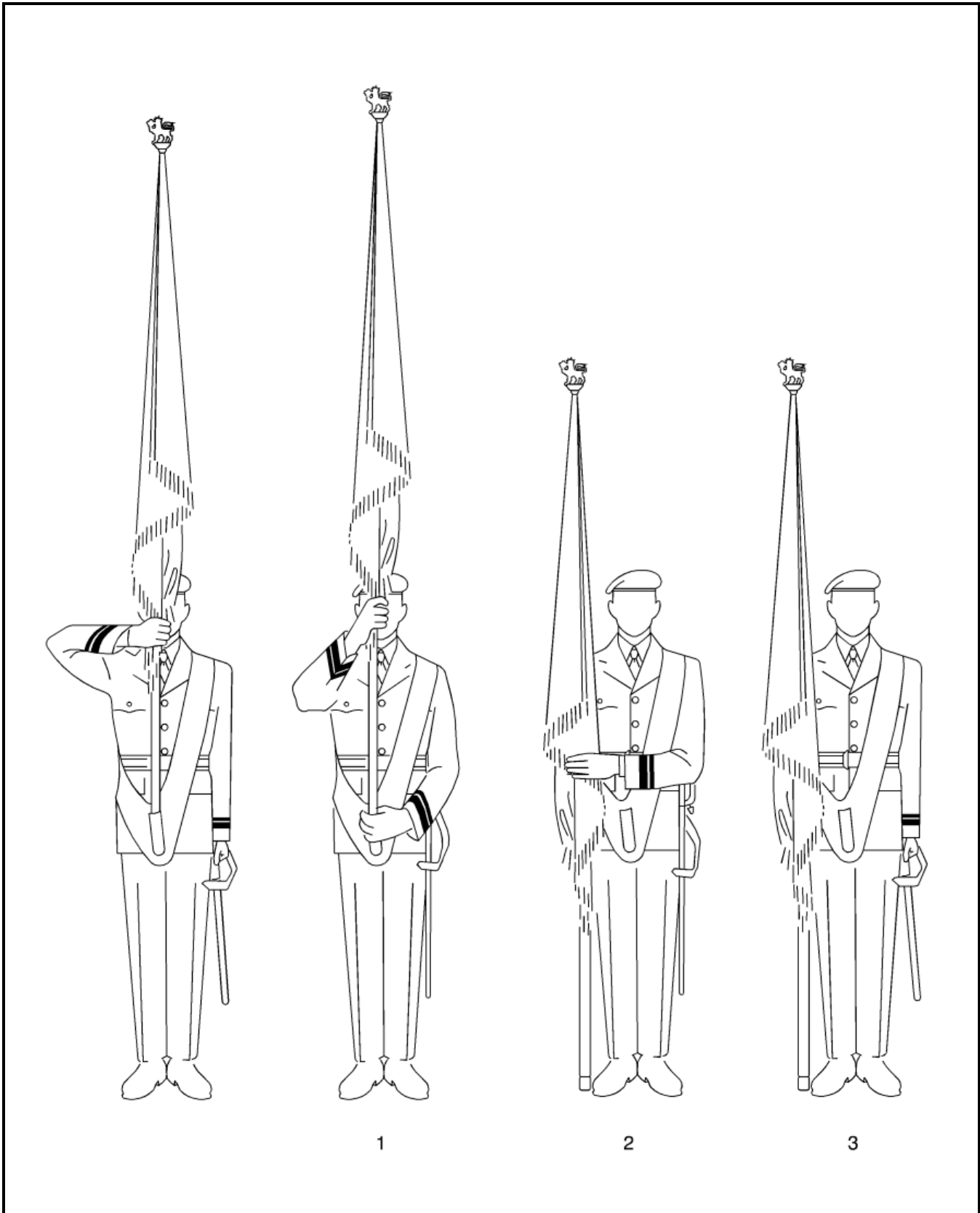

Figure 8-3- 4 Order from the Carry

- a. with the right hand raise the pike clear of the socket, bringing the right forearm from the horizontal position to a vertical position alongside the pike (Figure 8-3-5); and
 - b. simultaneously, bring the left hand to the socket to steady the pike and the belt.
22. On the command SQUAD – TWO:
- a. lower the Colour with the right hand to the right shoulder;
 - b. simultaneously, with the left hand grasp the pike above the right hand with an all-round grip, to steady the pike; thus
 - c. on completion of the movement:
 - (1) the Colour shall be at a 45 degree angle on the right shoulder,
 - (2) the elbow shall be close to the body,
 - (3) the right forearm should be in a comfortable position parallel to the ground,
 - (4) the Colour shall hang over and cover the right shoulder and arm, and
 - (5) the pike shall not show between the hand and the shoulder and shall be covered by the Colour.
23. On the command SQUAD – THREE, cut the left hand to the side assuming the position of the order.
24. On the command SLOPE – COLOUR, the three movements are combined. A standard pause shall be observed between the movements.
25. Upon departing the review parade ground or after paying compliments elsewhere, an uncased Colour normally should be returned to the slope in the following manner:
- a. On the command QUICK – MARCH, the Colour officer shall slope the Colour from the carry, executing the first movement on the first pace with the left foot and the remaining movements on successive paces with the left foot.
 - b. When the senior Colour officer gives the command SLOPE – COLOUR, after paying compliments on other than a review parade ground, the command is given on the left foot and the movements executed as above. When only one Colour is carried, the Colour officer shall carry out the movements without word of command.

SLOPE FROM THE ORDER (CASED COLOUR)

26. On the command SLOPE COLOUR(S) BY NUMBERS, SQUAD – ONE:
- a. with the right hand raise the pike clear of the ground and place it on the right shoulder (Figure 8-3-6); and
 - b. simultaneously, with the left hand grasp the pike above the right hand with an all-round grip, to steady the pike.
27. On the command SQUAD – TWO, cut the left hand smartly to the side, assuming the position of attention.
28. On the command SLOPE – COLOUR, both movements are combined, with a standard pause between movements. On the completion of the drill the Colour shall be at a 45 degree angle on the right shoulder, the right elbow close to the body and the right forearm in a comfortable position parallel to the ground.

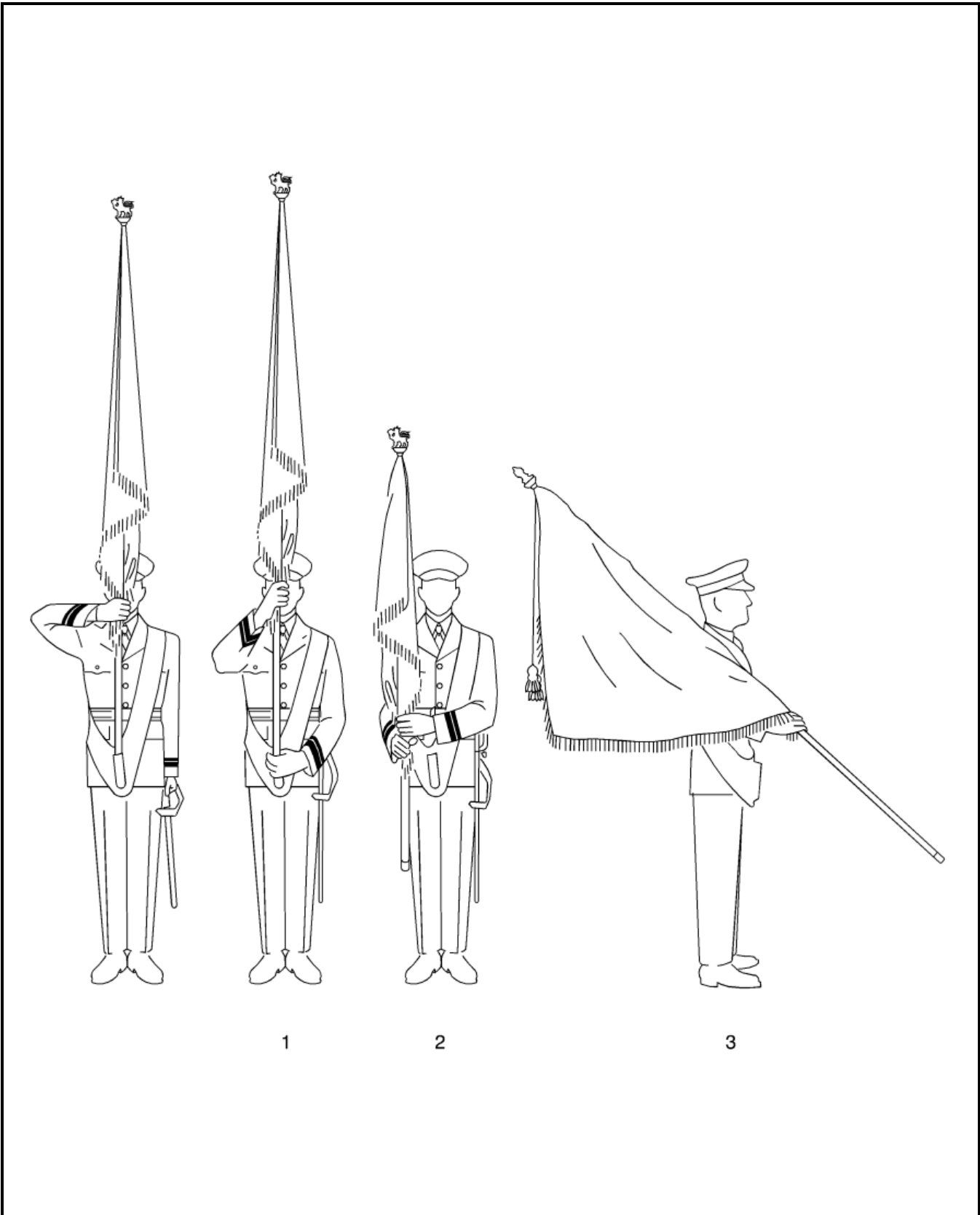

Figure 8-3- 5 Slope from the Carry

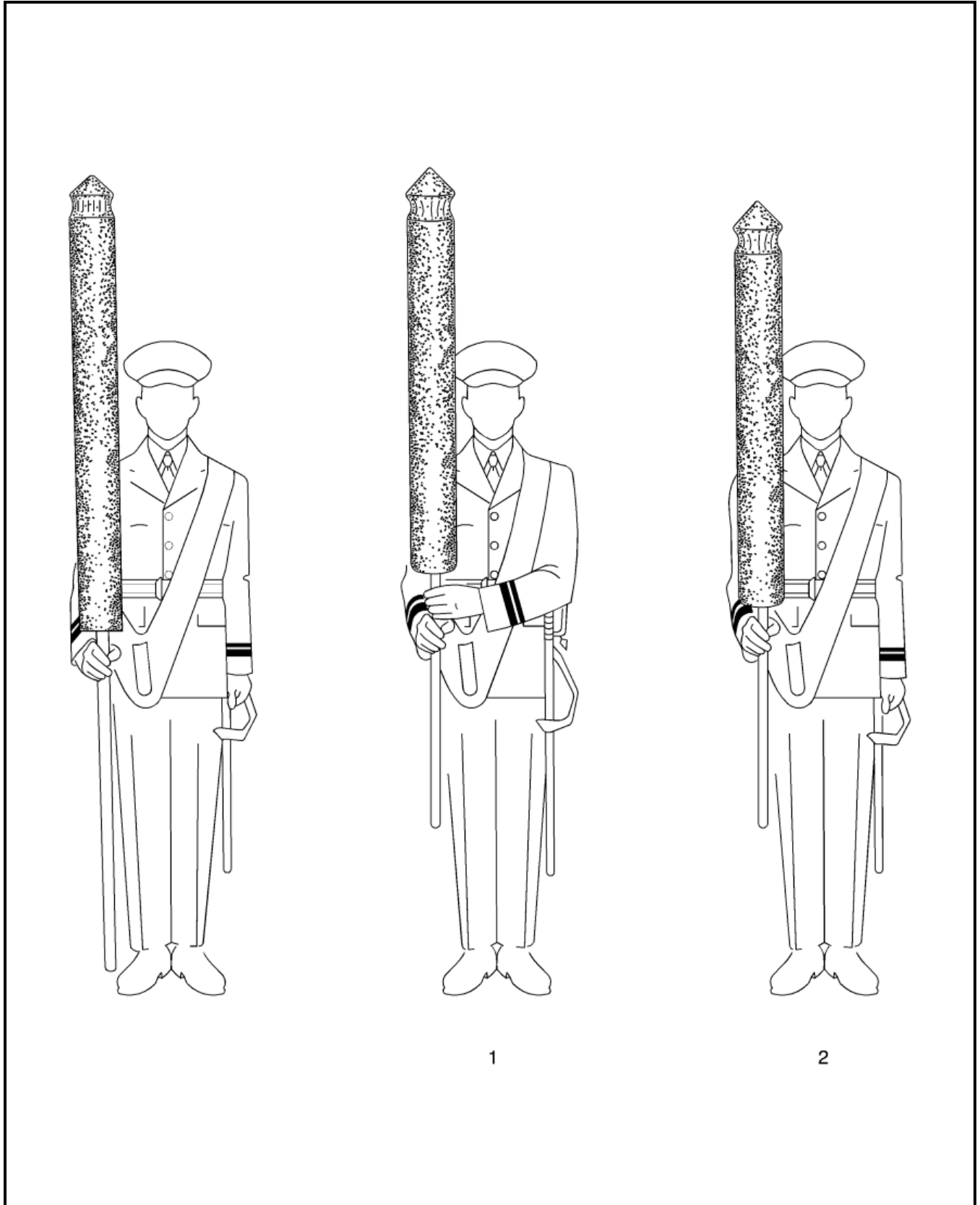

Figure 8-3- 6 Slope from the Order (Cased Colour)

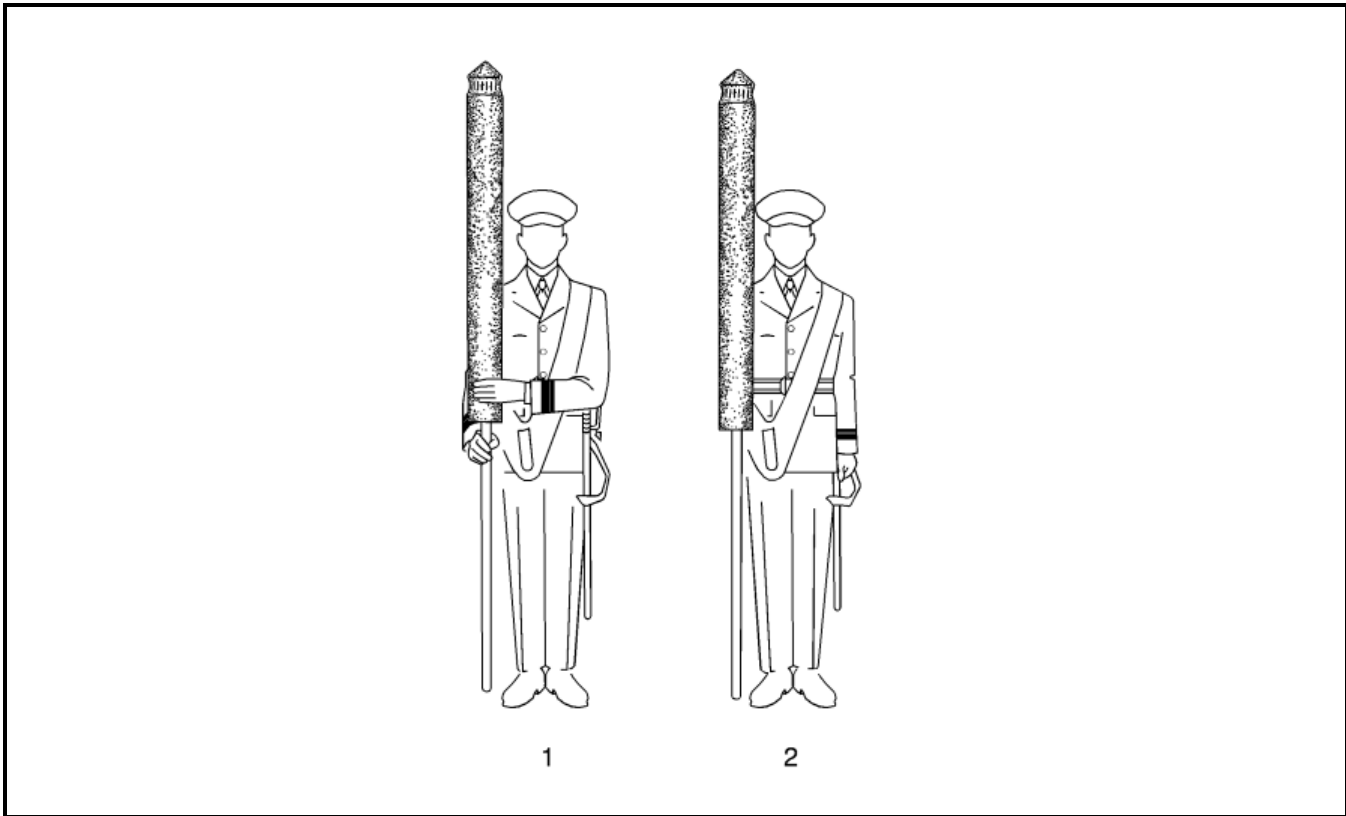

Figure 8-3-7 Order from the Slope (Cased Colour)

ORDER FROM THE SLOPE (CASED COLOUR)

29. On the command ORDER COLOUR(S) BY NUMBERS, SQUAD – ONE:
 - a. with the right hand lower the pike to the ground by straightening the right arm down the right side (Figure 8-3-7); and
 - b. simultaneously, bring the left arm smartly across the body, keeping the forearm parallel to the ground and steady the Colour by cupping the left hand around the case.
30. On the command SQUAD – TWO, cut the left arm smartly to the side, assuming the position of attention.
31. On the command ORDER – COLOUR, both movements are combined, with a standard pause between movements.

CHANGING THE COLOUR AT THE SLOPE

32. On the command CHANGE COLOUR(S) BY NUMBERS, SQUAD – ONE:
 - a. grasp the pike with the left hand above the right, in an all-around grip, back of the hand to the front, and thumb to the rear (Figure 8-3-8); and
 - b. keep the elbows close to the body.
33. On the command SQUAD – TWO:
 - a. carry the Colour, with the pike perpendicular, to a position 10 cm in front of the centre of the body; and
 - b. keep the elbows close to the body and both forearms parallel to the ground.

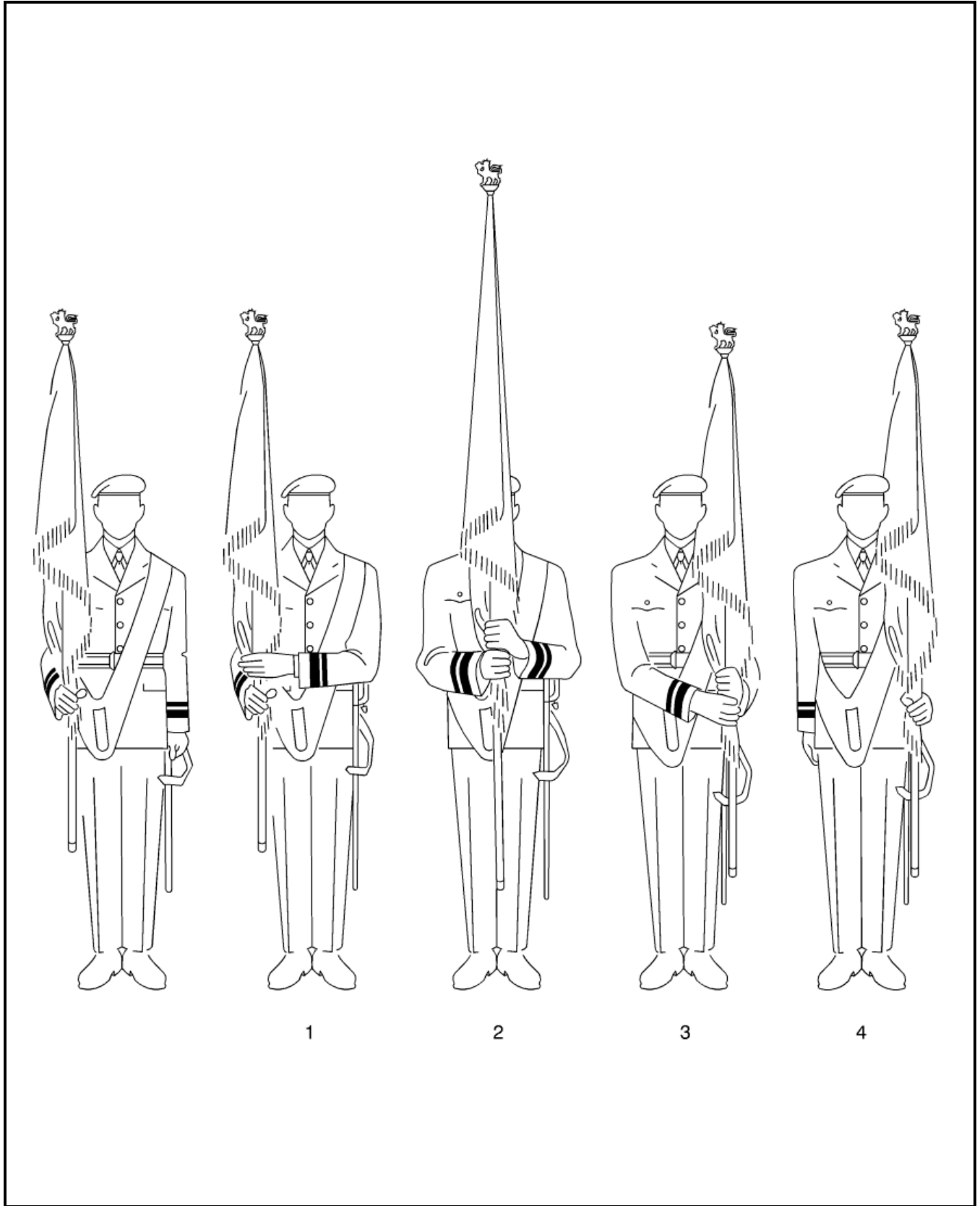

Figure 8-3- 8 Changing the Colour at the Slope

34. On the command SQUAD – THREE, place the Colour on the left shoulder, retaining the grip of both hands on the pike in a similar position to that described for the first movement above, except that the back of the right hand is now to the front.
35. On the command SQUAD – FOUR, cut the right hand to the side.
36. On the command CHANGE – COLOUR, combine the four movements, observing a standard pause between the movements.
37. To change Colour from the left to the right, the drill above is reversed.

CARRY FROM THE SLOPE

38. On the command CARRY COLOUR(S) BY NUMBERS, SQUAD – ONE:
 - a. raise the Colour off the right shoulder with the right hand to the perpendicular position of the carry from the order (Figure 8-3-9); and
 - b. simultaneously, bring the left hand to the socket to guide the base of the pike into the socket.
39. On the command SQUAD – TWO, cut the left hand to the side and assume the carry position.
40. On the command CARRY – COLOUR, the two movements are combined. A standard pause shall be observed between the movements.

LET FLY FROM THE CARRY

41. On the command LET FLY THE – COLOUR(S), maintaining the grip on the pike, release the Colour with a downward movement of the right hand (Figure 8-3-10). As the Colour is free, return the right hand to the previous position, in front of the mouth.
42. When arms are carried on parade and the order GENERAL SALUTE, PRESENT – ARMS is given, the Colour shall be let fly on the first movement of the present arms.
43. During the march past in quick time, on the command EYES – RIGHT, the Colour is let fly on the next left foot.
44. On the command EYES – FRONT, the Colour is caught as detailed in paragraph 45.

CATCHING THE COLOUR FROM THE LET FLY

45. On the command CATCH THE COLOUR(S) BY NUMBERS, SQUAD – ONE:
 - a. grasp the Colour with the left hand and bring it in to the pike (Figure 8-3-11); and
 - b. simultaneously, grasp the corner of the Colour with the right hand, back of the hand outwards, at the point of the pike where the lowest corner of the Colour reached.
46. On the command SQUAD – TWO, cut the left hand to the side to the position of attention and raise the right forearm to the horizontal position.
47. On the command CATCH THE – COLOUR, the two movements are combined. A standard pause shall be observed between the movements.

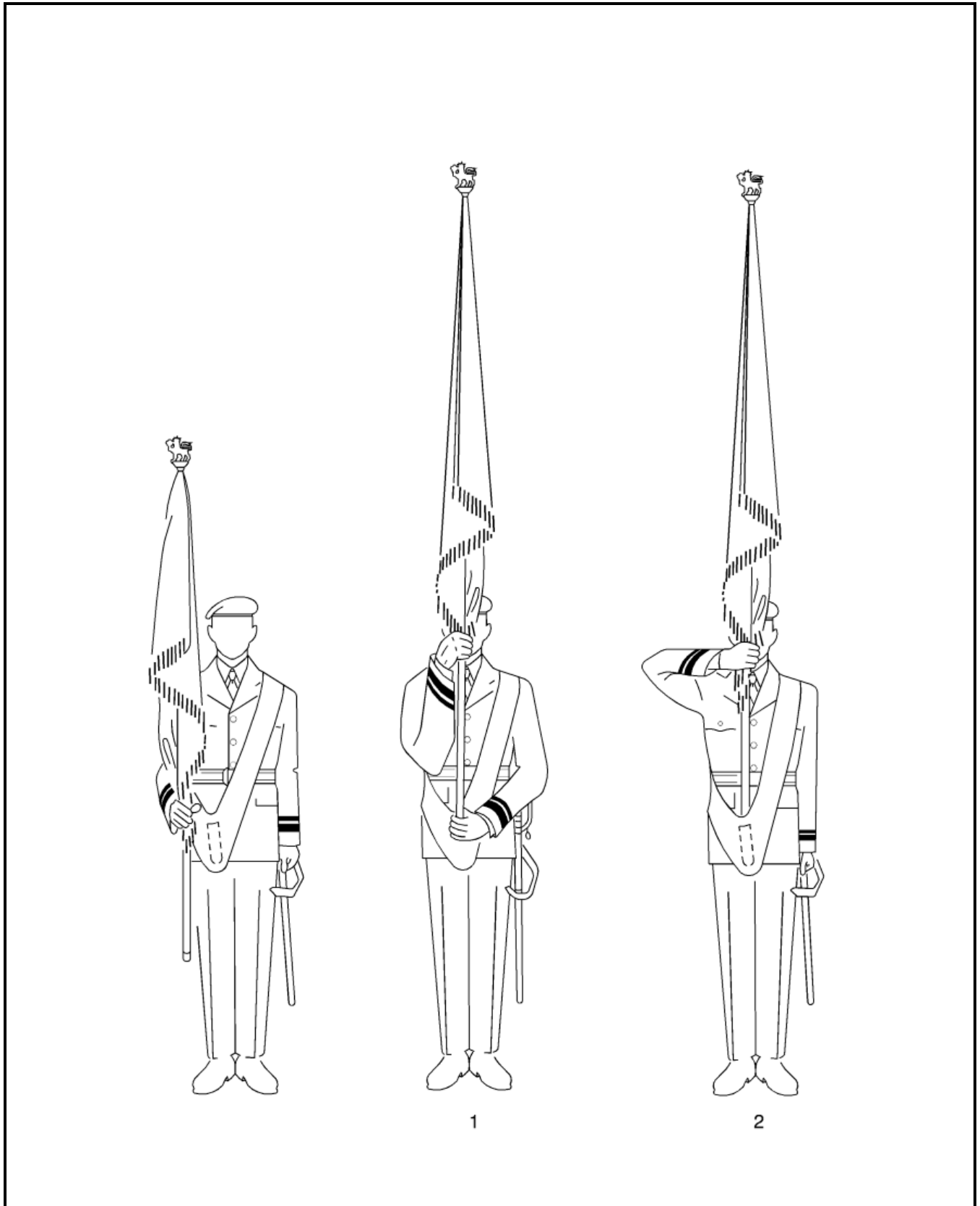

Figure 8-3- 9 Carry from the Slope

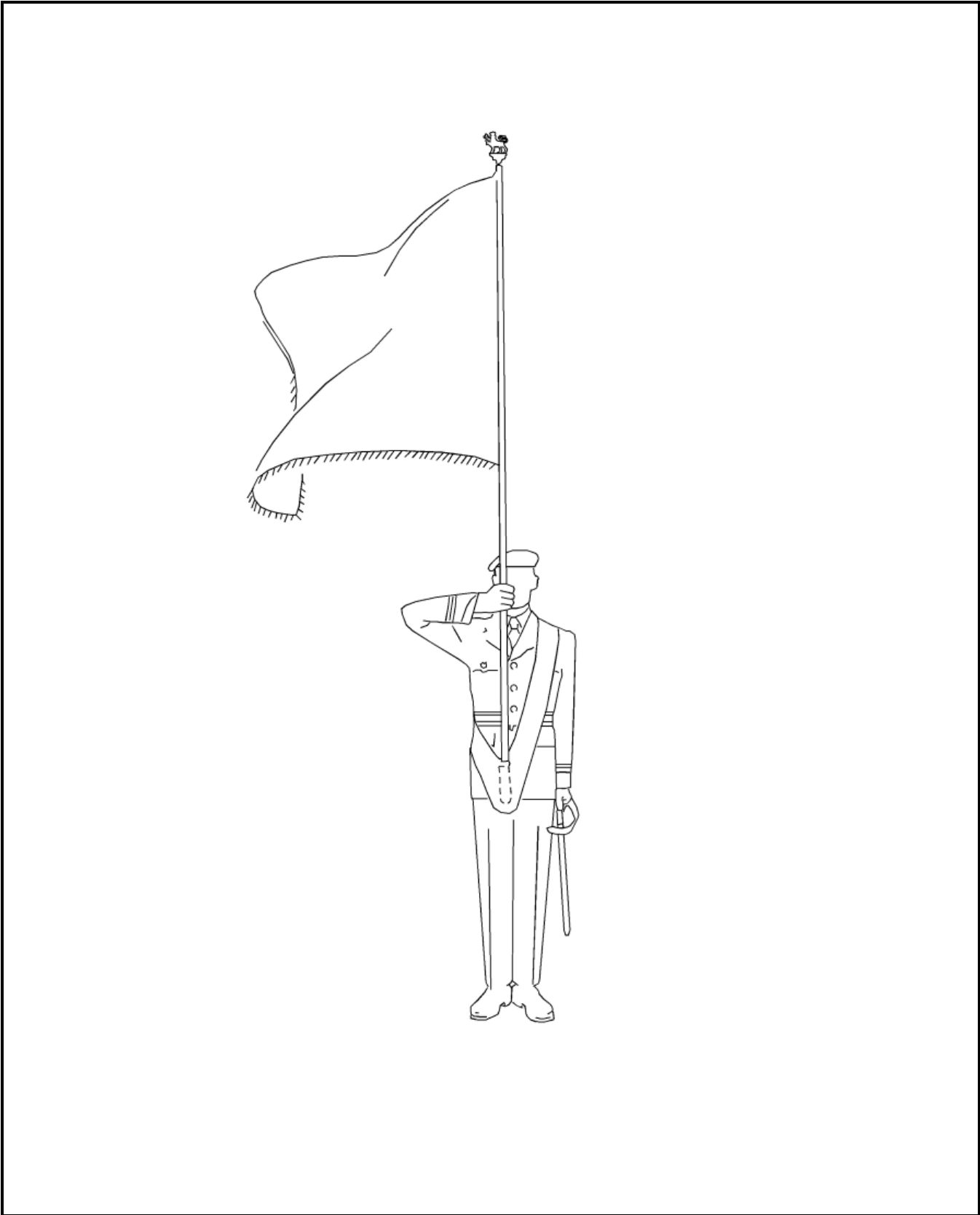

Figure 8-3- 10 Let Fly from the Carry

48. Depending on the wind direction, the Colour may be grasped with the right hand after securing the pike in the left hand. If, because of wind strength, the Colour cannot be caught, the Colour shall be brought to the position of the order, the Colour secured and returned to the carry. The same drill is executed while marching.

49. When arms are carried on parade and the parade is ordered to shoulder arms from the present, the Colour officer shall carry out the movements in time with the rifle movements.

DIP FROM THE CARRY AT THE HALT

50. On the command DIP THE COLOUR(S) BY NUMBERS, SQUAD – ONE:

- a. releasing the Colour from the pike, raise the pike to the full extent of the right arm (Figure 8-3-12); and
- b. simultaneously, bring the left hand across the body and grasp the socket to steady the Colour belt.

51. On the command SQUAD – TWO:

- a. maintaining control of the base of the pike with the right armpit, carry the pike well out to the right with the right hand and lower it with a sweeping motion to a position in front of the right foot;
- b. simultaneously, cut the left hand to the side to the position of attention; thus
- c. on completion of the movement:
 - (1) the pikehead shall be just clear of the ground,
 - (2) the Colour shall be spread on the ground to the right of the pike (see paragraph 54), and
 - (3) the pike shall be held under the right armpit, the back of the right hand towards the ground.

52. On the command DIP – COLOUR, the two movements are combined. A standard pause shall be observed between the movements.

53. If the ground is wet or muddy, the pikehead shall be 5 cm above the ground. The Colour shall be held in the left hand to prevent it from being soiled (Figure 8-3-13).

54. If a strong wind is blowing from the right, the pike shall be carried with the right hand well to the left, and then lowered with a sweeping motion to the position of the dip. The Colour shall be spread to the left of the pike.

55. When arms are carried on parade and the order ROYAL SALUTE, PRESENT – ARMS is given, the Colour officer shall coordinate the movements of the dip with the rifle movements, the Colour spread on the ground coincident with final rifle movement.

CARRY FROM THE DIP AT THE HALT

56. On the command CARRY COLOUR(S) BY NUMBERS, SQUAD – ONE:

- a. raise the Colour with the right hand, to the perpendicular position of the carry; and
- b. simultaneously, bring the left hand to the socket to guide the base of the pike into the socket.

57. On the command SQUAD – TWO:

- a. grasp the Colour with the left hand and bring it in to the pike; and
- b. simultaneously, grasp the corner of the Colour with the right hand as for the carry.

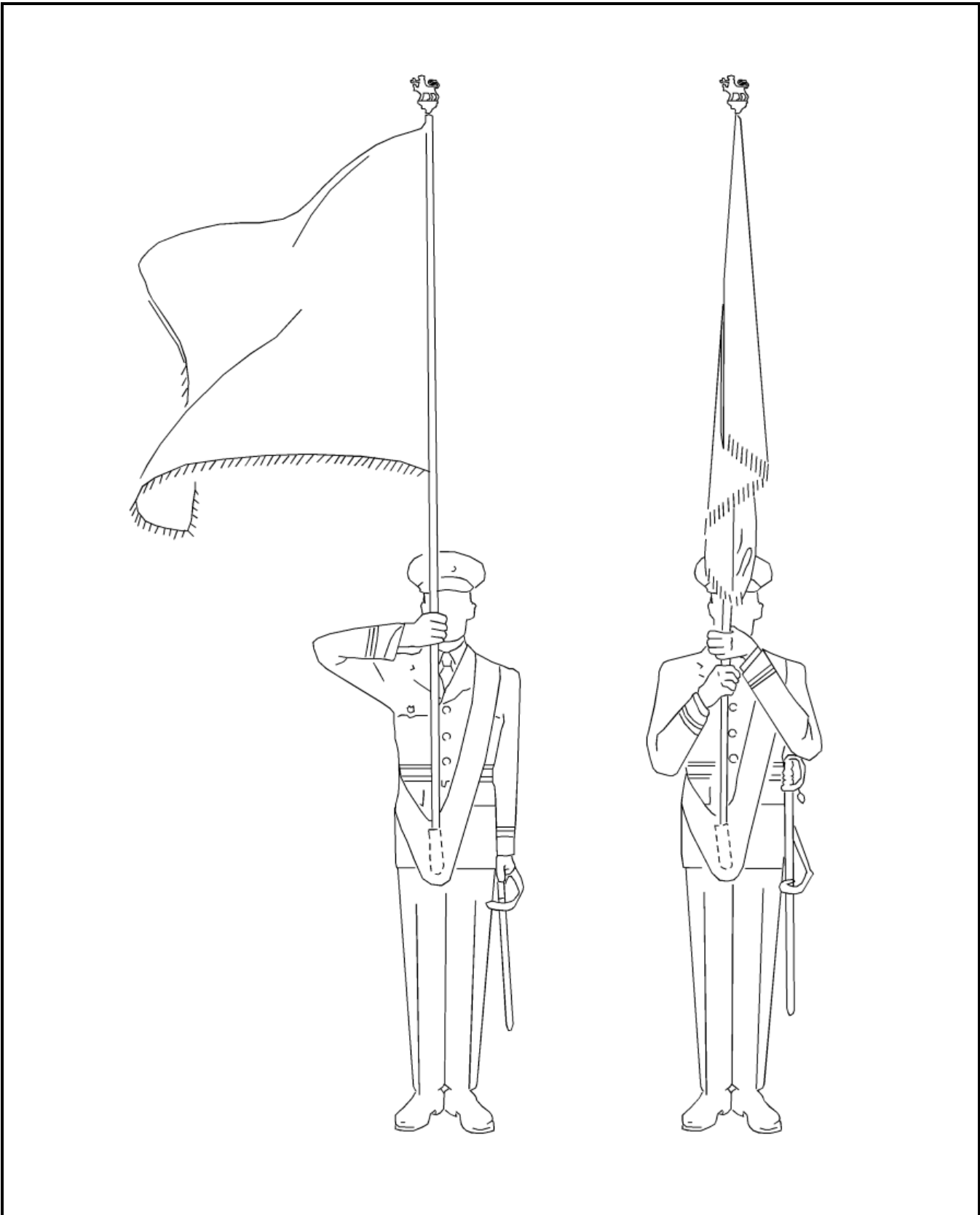

Figure 8-3- 11 Catching the Colour from the Let Fly

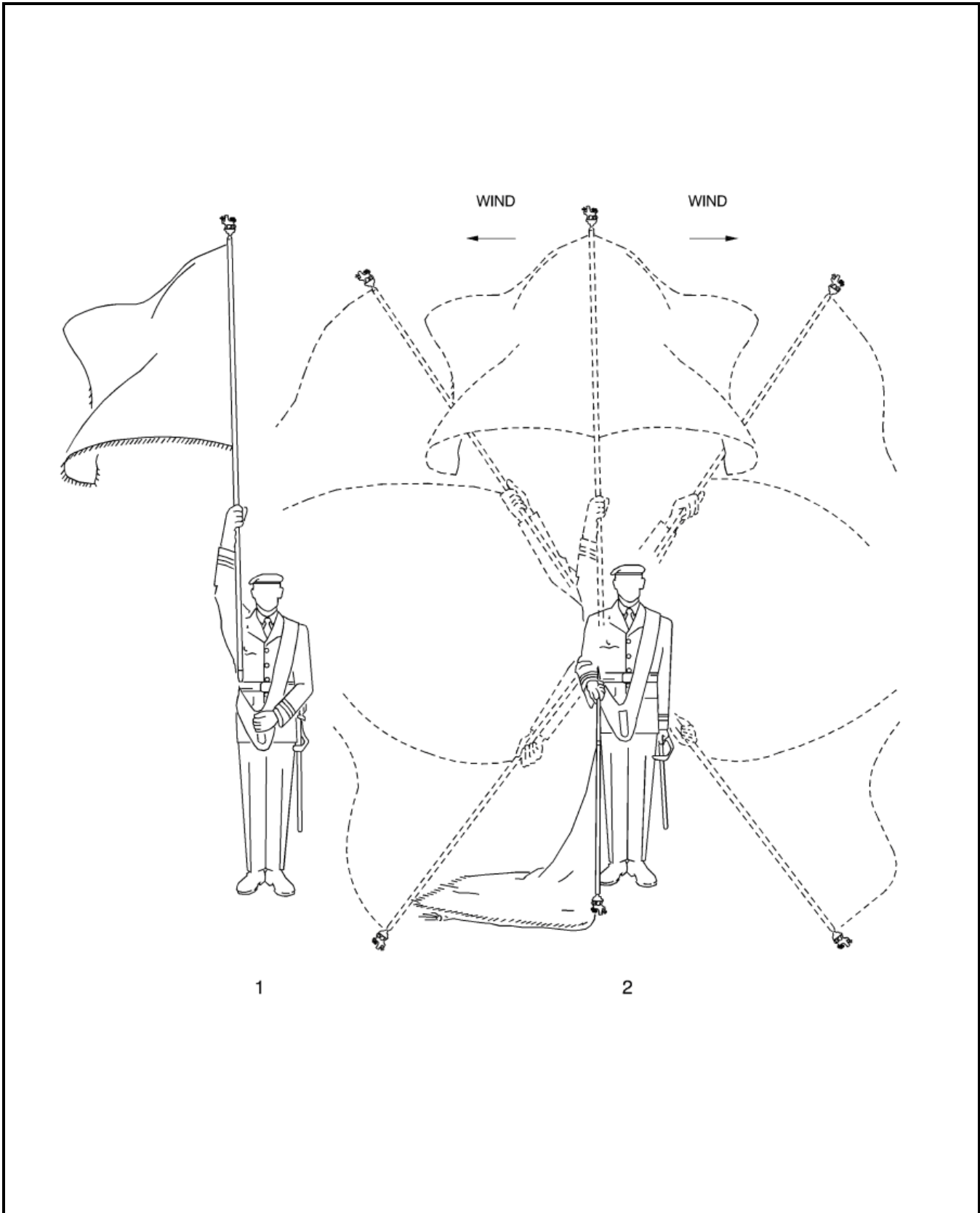

Figure 8-3- 12 Dip from the Carry at the Halt

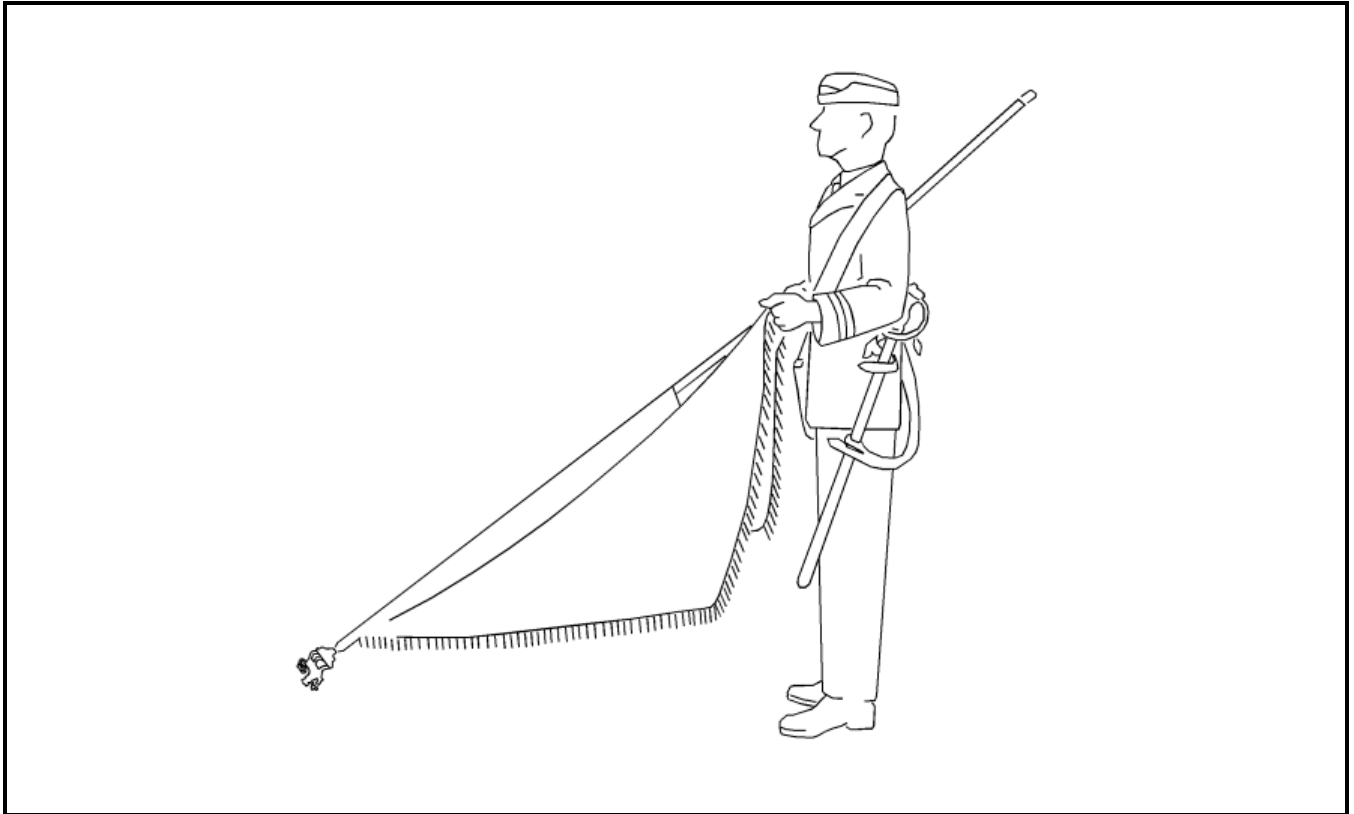

Figure 8-3- 13 Dip Position – Wet Ground

58. On the command SQUAD – THREE, cut the left hand to the side and assume the position of the carry.
59. On the command CARRY – COLOUR, the three movements are combined. A standard pause shall be observed between the movements.
60. When arms are carried on parade and the parade is ordered, SHOULDER – ARMS, following the command ROYAL SALUTE, PRESENT – ARMS, the Colour officer shall execute the first two movements of the carry from the dip, at the halt, in time with the two movements of the shoulder arms.

DIP FROM THE CARRY ON THE SLOW MARCH (CONSACRETED COLOURS ONLY)

61. The dip is only executed on the march in slow time.
62. On the command EYES – RIGHT given as the left foot is forward and on the ground, the Colour shall be let fly on the next pace with the left foot (Figure 8-3-14).
63. On the following pace with the left foot:
 - a. grasp the socket with the left hand; and
 - b. raise the pike clear of the socket with the right hand.
64. On the next pace with the left foot:
 - a. maintaining control of the base of the pike under the right armpit, move the Colour in a sweeping motion to the right and lower the pike to a horizontal position directly in front; and
 - b. simultaneously, cut the left hand to the side.

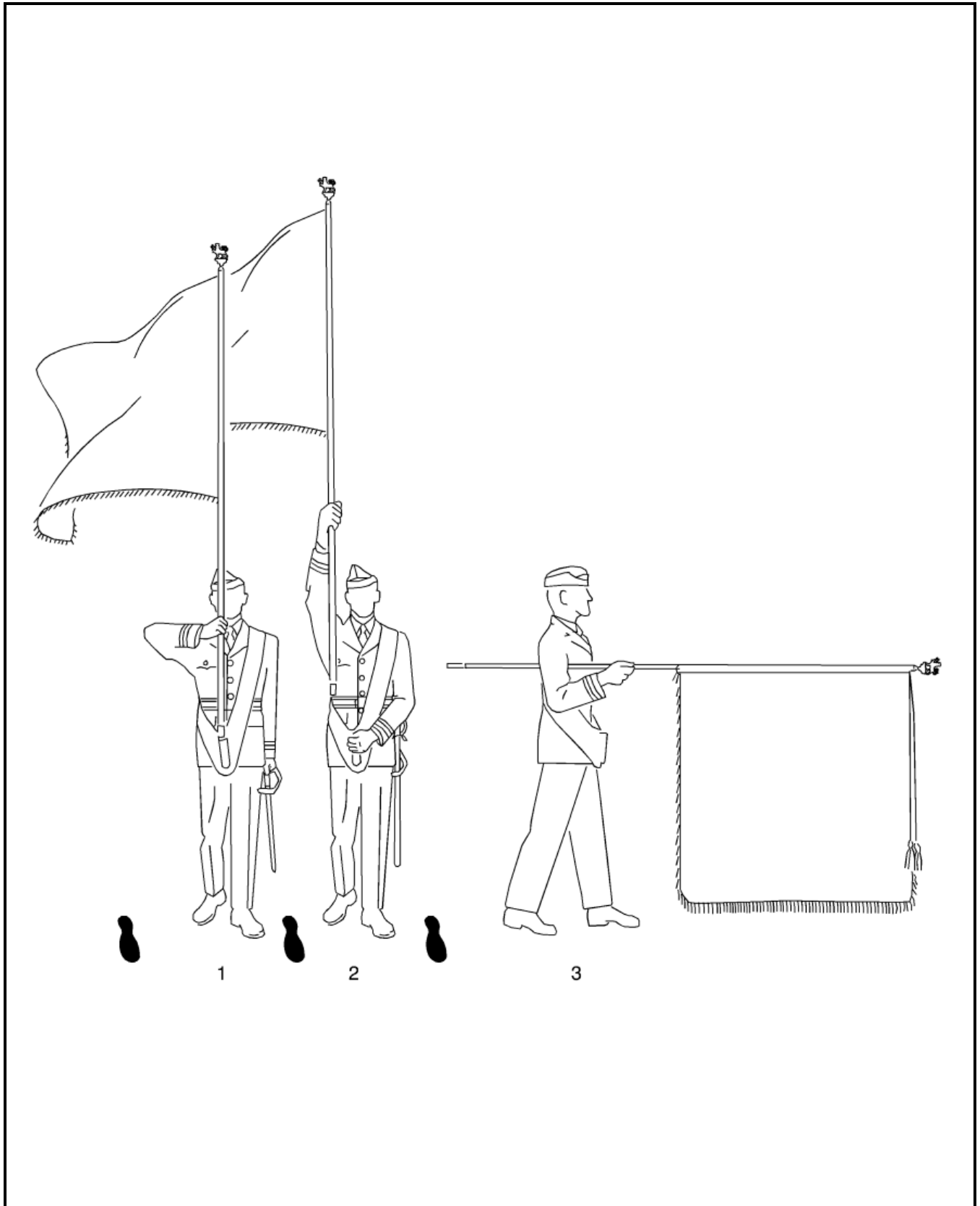

Figure 8-3- 14 Dip from the Carry on the March

65. On completion of the movement:
- a. the back of the right hand shall be towards the ground;
 - b. the right elbow shall be close to the side;
 - c. the Colour shall hang straight down;
 - d. the left arm shall be straight at the side; and
 - e. the head and eyes shall be straight to the front.

CARRY FROM THE DIP ON THE MARCH

66. On the command EYES – FRONT, on the next pace with the left foot:
- a. raise the Colour with the right hand, to the perpendicular position of the carry; and
 - b. simultaneously, bring the left hand to the socket to guide the base of the pike into the socket.
67. On the following pace with the left foot, the Colour shall be caught with the left hand, and the corner of the Colour shall be grasped with the right hand.
68. On the next pace with the left foot, cut the left hand to the side.
69. If the wind is strong, the Colour may be secured as noted in paragraph 45.

SECTION 4

REMOVING AND LODGING THE COLOURS

GENERAL

1. When the Colours are removed and returned to the place where they are lodged, they shall be escorted by a Colour party.

REMOVING THE COLOURS

2. The procedure for removing Colours from the mess or other lodging shall be:
 - a. the Colour bearers shall collect the Colours from their place of safekeeping, case them as necessary (see paragraph 3) within the lodging's shelter and wait for the arrival of the escort;
 - b. the escort for the Colour shall be marched to the lodging, halted facing the place and bayonets shall be fixed;
 - c. the Colour bearers shall leave the lodging and fall in, the Queen's Colour on the right; and
 - d. under command of the senior Colour officer, the Colour party shall march to the parade ground, Colours cased at the slope.
3. If the lodging is next to or close by the parade ground, the Colours may be fallen in uncased. In this event:
 - a. the senior member of the escort shall order PRESENT – ARMS as the Colours exit the lodging; and
 - b. the senior Colour officer shall order SHOULDER – ARMS after the Colours have been fallen in.

LODGING THE COLOURS

4. After the completion of the parade, when the Colours have been marched off and cased, the senior Colour officer shall march the Colour party to the place where they are to be lodged, with the Colours at the slope. The Colour officers shall enter and return the Colours for safe-keeping.
5. If the lodging is next to or close by the parade ground, they may be returned uncased. In this event:
 - a. the senior Colour officer shall order the escort to PRESENT – ARMS; and
 - b. the Colour officers shall carry the Colours into the lodging and, after they are in the place, the senior member of the escort shall order SHOULDER – ARMS.
6. Under the command of the senior member of the Colour escort, the escort shall then unfix bayonets and if not requested to attend Colour Officers, shall directly march off to the dismissal area.

SECTION 5

CASING AND UNCASING THE COLOURS

CASING THE COLOURS

1. After being marched off parade, unless the place for lodging is close-by, the Colour party moves to the side of the parade ground and takes up a position facing the flank of the unit. The Colour orderlies fall in side by side, three paces to the left of the Colour party.
2. The Colour officers come to the order and the senior orders CASE, THE COLOUR(S).
3. On this command, the Colour orderlies move to a position four paces in front of and facing their respective Colour, halt, salute, take one pace forward and raise their left forearm parallel to the ground, cupping the left hand.
4. The Colour officers lower the pikes, directly forward, to a horizontal position, as for the last movement of the dip on the march, bringing the crests to rest in the orderlies, cupped left hands (Figure 8-5-1).
5. The Colour officers, with the left hand, and the orderlies, with the right hand, grasp the bottom corner of the Colour nearest to them and together fold the bottom edge of the Colour over the pike, ensuring that the fringe also hangs over the pike. The above procedure is executed three times, ensuring that there are no creases and that the Colours are neatly rolled along the top of the pike. As the Colour is folded, successive folds are held in place by the right thumb of the Colour officer and the left thumb of the orderly. The orderlies then wrap the tasselled cords around the Colours three times along their width. The Colour officers grasp the ends of the cords and the Colour in their left hand.
6. The orderlies remove the cases from their left forearms and carefully slide them over the Colours. As the cases are slid to the bottom of the Colours, the Colour officers, with their left hand, assist in pulling the cases fully over the Colours. The officers then tie the laces while the orderlies steady the horizontal pikes. When finished, Colour officers then cut their left arms sharply to the side.
7. When the cases are in place, the orderlies resume their original position, cupping the caps in their left hand, and, upon a signal from the Colour officers, give the pikes an upward thrust with the left hand, assisting the officers to return the Colours to the order position. The orderlies cut their left arms smartly to the side.

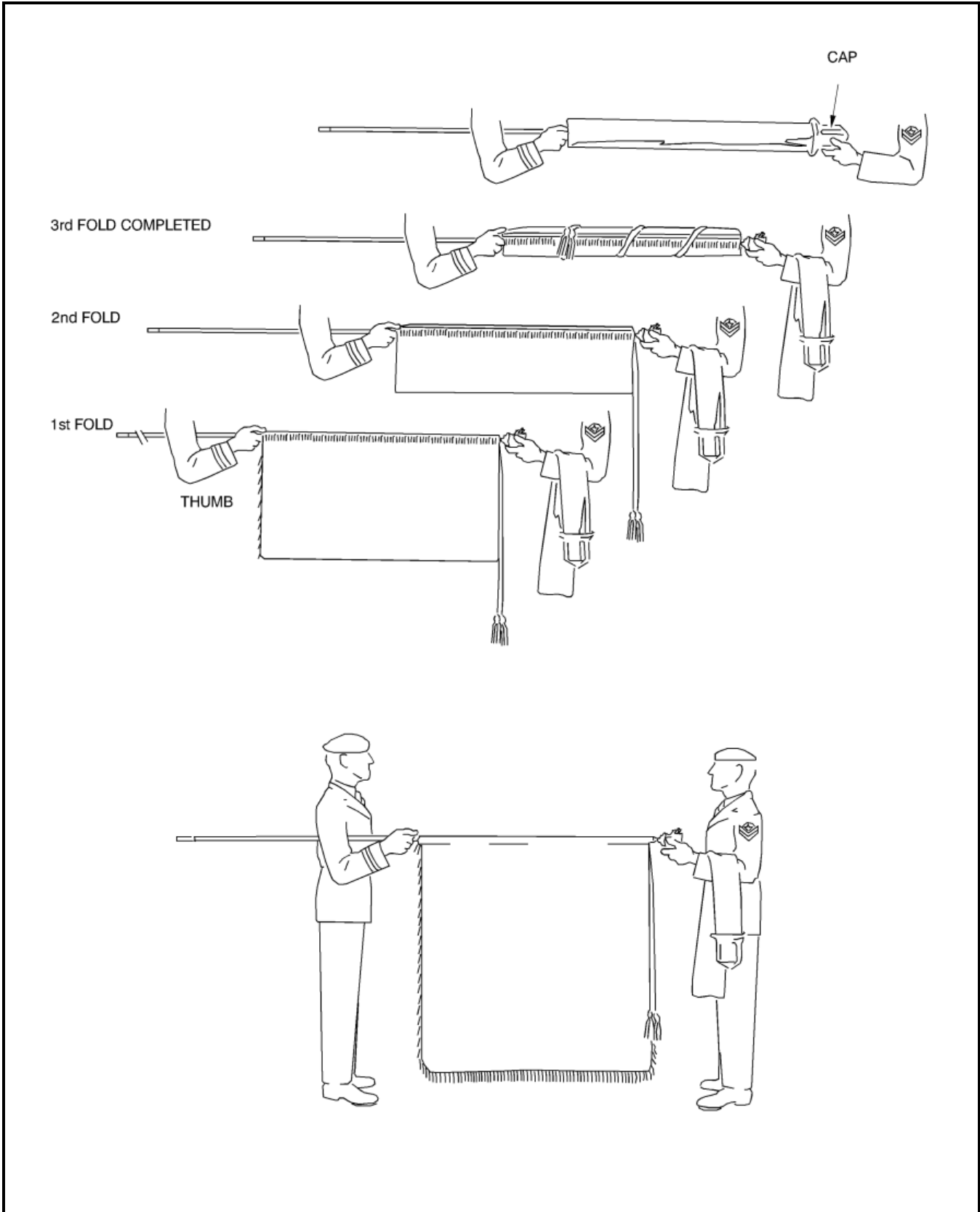

Figure 8-5- 1 Casing and Uncasing the Colours

8. The orderlies step back to their original position, salute, turn right and march off the parade ground.
9. The Colour party, under command of the senior Colour officer, returns the Colours to their lodging.

UNCASING THE COLOUR

10. On arrival at the parade ground, the Colour party positions itself on the nearest flank of the parade, the orderlies falling in three paces to the left of the Colour party.
11. The senior Colour officer, at the order position, commands UNCASE, THE COLOUR(S).
12. On this command, the Colour orderlies move to a position four paces in front of, and facing, their respective Colour. They halt, salute, take one pace forward and raise their left forearm parallel to the ground, cupping the left hand.
13. The Colour officers lower the pikes directly forward to a horizontal position, as for the last movement of the dip on the march. The caps are brought to rest in the cupped left hands of the orderlies.
14. The Colour officers untie the tapes of the case and grasp the Colours with their left hand inside the case. The orderlies carefully remove the cases and place them over their left forearm, the caps to the left.
15. The senior Colour officer shall then order COLOUR PARTY, TO THE COLOUR, PRESENT – ARMS.
16. The orderlies then unroll the cords, the Colour officers release the Colour and cut the left arms smartly to the side. The Colour orderlies then ensure that the Colours and cords hang correctly.
17. On a signal from the Colour officers, the orderlies give the pikes an upward thrust, assisting the officers to return the Colours to the order position. The orderlies then cut their arms smartly to the side.
18. The Colour officers dress the Colours to ensure that they are evenly distributed on both sides of the pike. The orderlies assist if required.
19. The orderlies step back to their original position, salute, turn right and march off the parade ground to a pre-designated location.
20. The senior Colour officer then shall order COLOUR PARTY, SHOULDER – ARMS.

SECTION 6**MARCHING ON AND OFF THE COLOUR****MARCHING ON THE COLOUR**

1. Colours shall be held at the carry while being marched on and off parade.
2. On the command MARCH ON THE COLOUR(S), given by the parade commander, the following shall take place:
 - a. the senior Colour officer shall order the cautionary COLOUR PARTY;
 - b. the parade commander shall order TO THE COLOUR(S), PRESENT – ARMS; and
 - c. the senior Colour officer shall order BY THE RIGHT (CENTRE), QUICK – MARCH. If a band is on parade, it shall play appropriate music.
3. The Colour party shall march to its position by a series of forms and counter-marching (Figure 8-6-1). Upon halting in its parade position, the senior Colour officer orders COLOUR PARTY, TO THE COLOUR(S), PRESENT – ARMS.
4. Once the Colour escort is at the present, the parade commander orders SHOULDER – ARMS, and the parade, now including the Colour party, shoulders arms.
5. Until it is ordered off at the conclusion of the parade, the Colour party shall act normally on the parade commander's command, except in the following circumstances:
 - a. During an inspection, the Colour shall be held in the carry position.
 - b. When required to move to a flank independently, the Colour party shall do so under command of its senior Colour officer by executing forms at the halt or on the march.

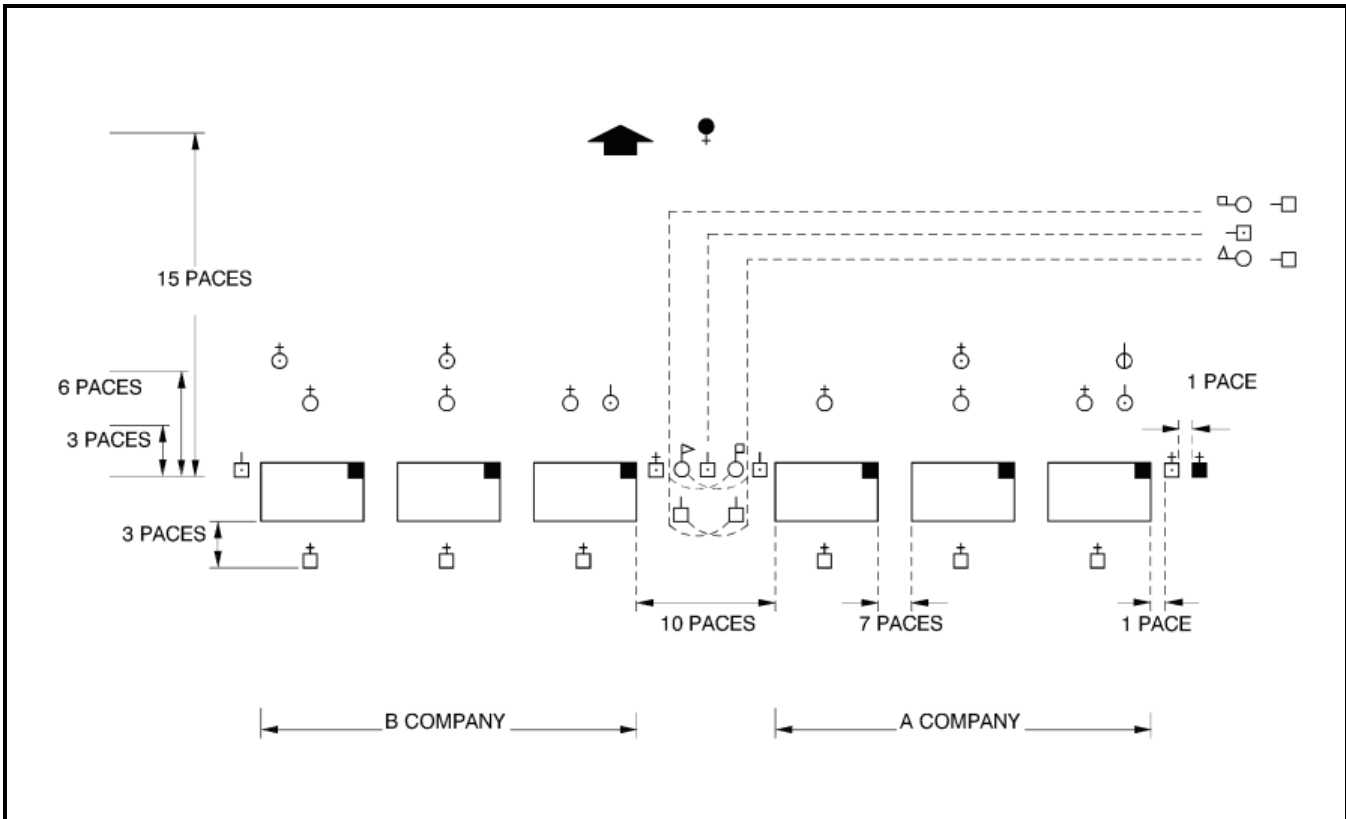

Figure 8-6-1 Marching on and off the Colour (Battalion in Line)

MARCHING OFF THE COLOUR

6. On the conclusion of the parade, the parade commander shall order MARCH OFF THE – COLOUR(S).
7. The senior Colour officer shall order the cautionary COLOUR PARTY.
8. The parade commander shall order TO THE COLOUR(S), PRESENT – ARMS.
9. The senior Colour officer shall order BY THE RIGHT (CENTRE), QUICK – MARCH. If a band is present, it shall play appropriate music.
10. The Colour party, by forming, shall march off the parade ground to the left or right flank (Figure 8-6-1).
11. While marching with the unit, the colour party shall conform to the movements of the parade (e.g. wheeling or forming)
12. When turning at the halt is required (e.g. for a march past in column of route), the Colour party shall change direction by executing a number of marking time paces (e.g. 20) and manoeuvring into position.
13. It is permissible to march on/off the Colours by wheeling in lieu of forms, if the circumstances exist. (e.g. the Colour Party is not trained to do forms in an exceptional manner). Forms being preferred.

SECTION 7

POSITIONS OF COLOURS ON PARADE

BATTALION PARADE

1. The Colours shall be positioned in the centre of the battalion as described below. If the battalion has an odd number of companies on parade, the Colours shall be positioned in the first interval between companies toward the honour side of the battalion's centre, i.e., to the right in line and mass, and to the front in column of companies.
2. **Battalion in Line.** The Colours shall be positioned between the two centre companies as follows:
 - a. **One Colour.** The Colour officer is positioned in line with the front rank and the escort in line with the rear rank.
 - b. **Two Colours.** The Colour officers and Colour warrant officer are positioned in line with the front rank and the sergeants in line with the rear rank (Figure 8-6-1).
3. **Battalion Retired.** If the battalion is ordered to retire, the Colour party will turn about, but will remain steady in its original alignment.
4. **Battalion in Column of Route/Column of Threes.** The Colours shall be positioned between the two centre companies as follows:
 - a. **One Colour.** The Colour officer covers off the centre file of the battalion and the Colour escorts cover off the flank files.
 - b. **Two Colours.** The Colour officers and the Colour escorts cover off the flank files of the battalion and the warrant officer covers off the centre file.
5. **Battalion in (Close) Column of Companies.** The Colour party shall be positioned between the front company and the centre company; when marching past, the following positioning will be observed:
 - a. **One Colour.** Alignment shall be with the supernumerary rank of the company in front.
 - b. **Two Colours.** The two sergeants shall take post by moving up on the right and left of the Colours respectively, the whole party being aligned with the supernumerary rank of the company in front (Figure 8-7-1).
6. **Battalion in Mass.** The Colour party shall be positioned between the two centre companies as follows:
 - a. **One Colour.** The Colour officer is positioned in line with the front rank of the leading platoons and the escorts in line with the rear rank of these same platoons.
 - b. **Two Colours.** The Colour officers and the Colour warrant officer are positioned in line with the front rank of the leading platoons and the sergeants in line with the rear rank of these same platoons (Figure 8-7-2).
7. **Review Order.** The Colour bearers shall advance as noted in Chapter 9, Section 2, paragraph 13 when ordered to take post in review order.

GUARDS OF HONOUR

8. When paraded with a guard of honour, Colours shall be positioned in review order prior to the arrival of the dignitary for whom the guard is being mounted.
9. When flags are paraded with a guard of honour, they maintain position and are not advanced in review order (see also Chapter 9, Section 2, paragraph 13).

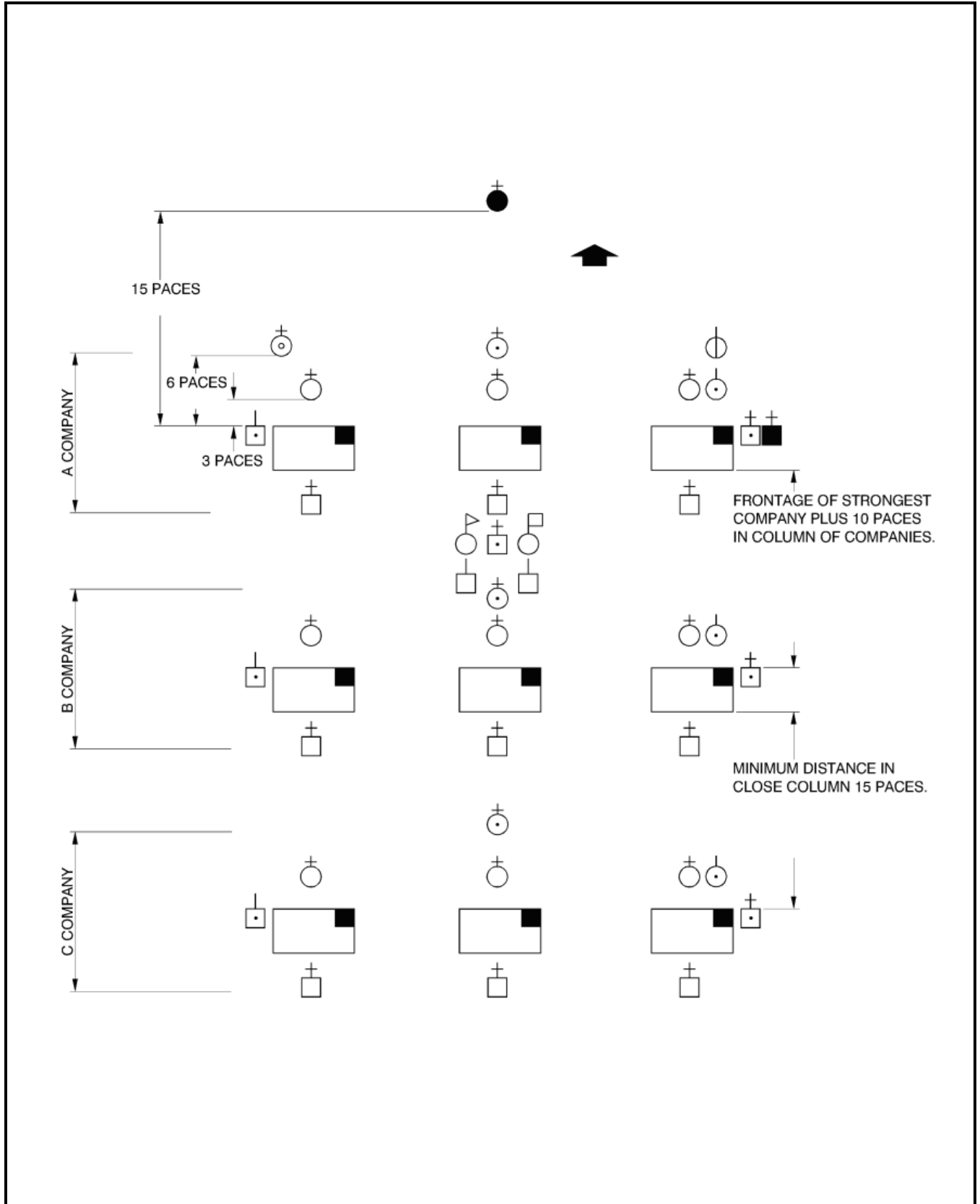

Figure 8-7- 1 Colours on Parade (Battalion in Close Column)

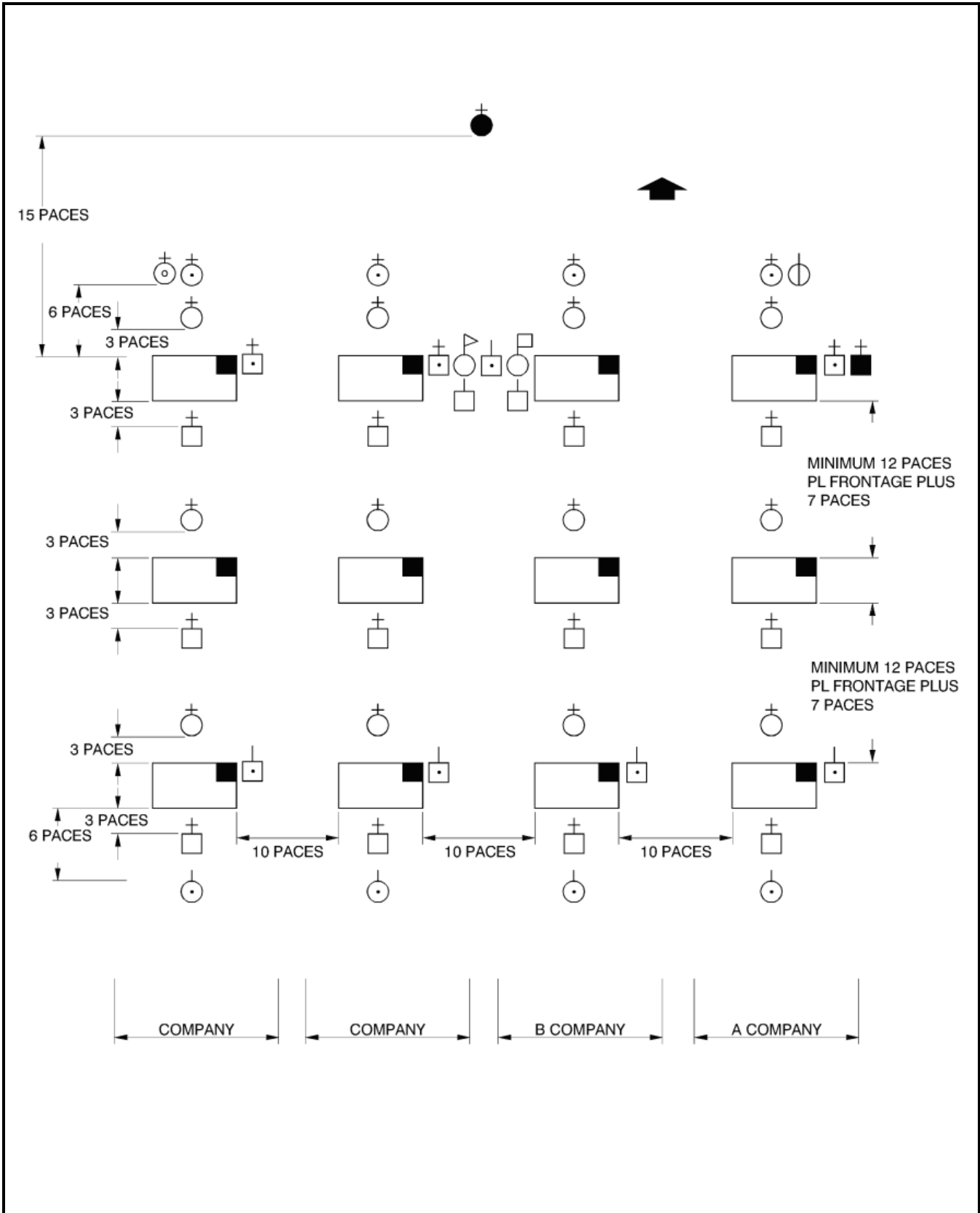

Figure 8-7- 2 Position Colours on Parade (Battalion in Mass)

CHAPTER 9
BATTALION CEREMONIAL
SECTION 1
GENERAL

INTRODUCTION

1. While drill movements shall be performed the same by all so that the Canadian Armed Forces can march and manoeuvre as one to common words of command, commanders may adjust parade procedures according to circumstances and unit customs. For example:
 - a. the battalion may form up in line, column or close column of companies, or mass depending on the size and shape of the parade ground;
 - b. the companies may manoeuvre around the ground by forms, turns or wheels; and
 - c. the march past may be in column of companies or column of route.
2. Protocol will be observed when planning a parade. In particular:
 - a. senior individuals join a parade last and leave first, accompanied, in the case of reviewing dignitaries, by their retinue (the reviewing officer is to arrive last); and
 - b. units will be formed up in order of precedence.
3. Protocol may be varied if justified by unique circumstances. For example, although normal precedence within a sized battalion is alphabetical by companies, on special occasions commanding officers may parade prize-winning companies on the right of the line, the position of honour.
4. Parades follow a common sequence as follows:
 - a. The battalion is formed on parade, the officers fall in and the Colours are marched on. The battalion is now ready to carry out the tasks for which it has paraded.
 - b. The tasks are completed.
 - c. The Colours are marched off, the officers fall out and the troops are dismissed.
5. When a ceremonial parade involves specific procedures, such as those for trooping a Colour, they are detailed elsewhere in this manual.

PROMENADING

6. A promenade is a slow, formal walk. Its origins lie in 18th Century European social customs for walking in public. It is carried out by officers waiting on duty, but off parade, prior to being fallen in. It is a procedure, not a drill movement, and officers promenading appear relaxed but attentive.
7. Officers will promenade at the edge of the parade ground near their troops singly or in groups of two or three and at a natural walking cadence, about 100 paces per minute. They shall informally watch parade activity, each group turning about together, in the direction of the troops, at the approximate boundaries of their troops' position on parade.

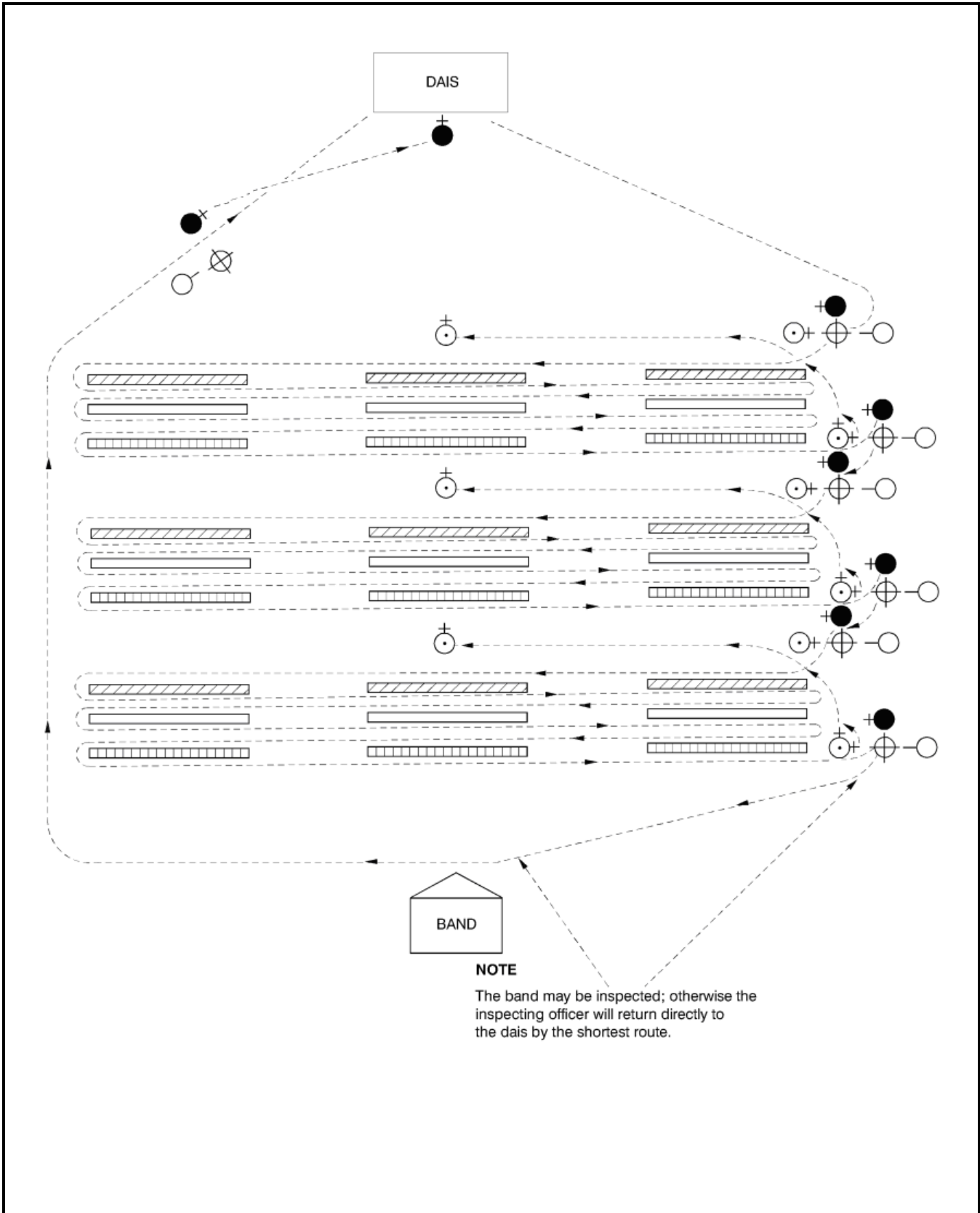

Figure 9-1-1 Inspection of Battalion in Close Column and Column

8. When parade activity has reached the point where the officers will soon be required, they shall take up positions on the edge of the parade ground, at ease, and await the order to fall in.

INSPECTIONS

9. Personnel are inspected at the position of attention.

10. Battalion inspections are normally carried out by companies. The battalion commander will order all but the company being inspected to stand at ease as follows: "A" COMPANY STAND FAST, REMAINDER STAND AT – EASE. Company commanders shall thereafter call their companies to attention as the inspecting officer approaches. Each company commander shall stand his company at ease on completion of the inspection (see also Section 2 for an inspection by a dignitary during a review).

11. The routes taken by an inspecting party are outlined in figures 9-1-1 to 9-1-3.

12. As the inspecting officer approaches the company from the right flank, the company commander shall march to a position six paces in front of the company's right marker, salute the inspecting officer as the latter approaches and accompany the inspecting party during the inspection of the company. On completion of the inspection, the company commander shall salute the inspecting officer and return to his position on parade.

PRESENTATIONS AND ADDRESSES

13. If presentations are to take place during a ceremonial parade, the recipients will be ordered to fall out.

14. If a recipient is armed with a sword, the sword shall be returned to its scabbard before the recipient falls out. If the recipient is armed with a rifle or carbine, the weapon shall be grounded before the recipient falls out. Pistols shall remain holstered.

15. The adjutant may be ordered to fall out to assist with the presentations.

16. On completion of the presentations, the recipients shall fall in.

17. Addresses on parade follow any presentations.

18. When a large unit is paraded in line, the commanding officer may order flank sub-units to incline inwards or the whole unit to form a hollow square, in order to improve visibility or hearing for members on the flanks during the presentation or address.

MOUNTED PARADES

19. Mounted parades are conducted in the same general manner as dismounted parades, with adjustments made to account for the presence of horses or vehicles and their size, turning radius, etc. (see Annex A).

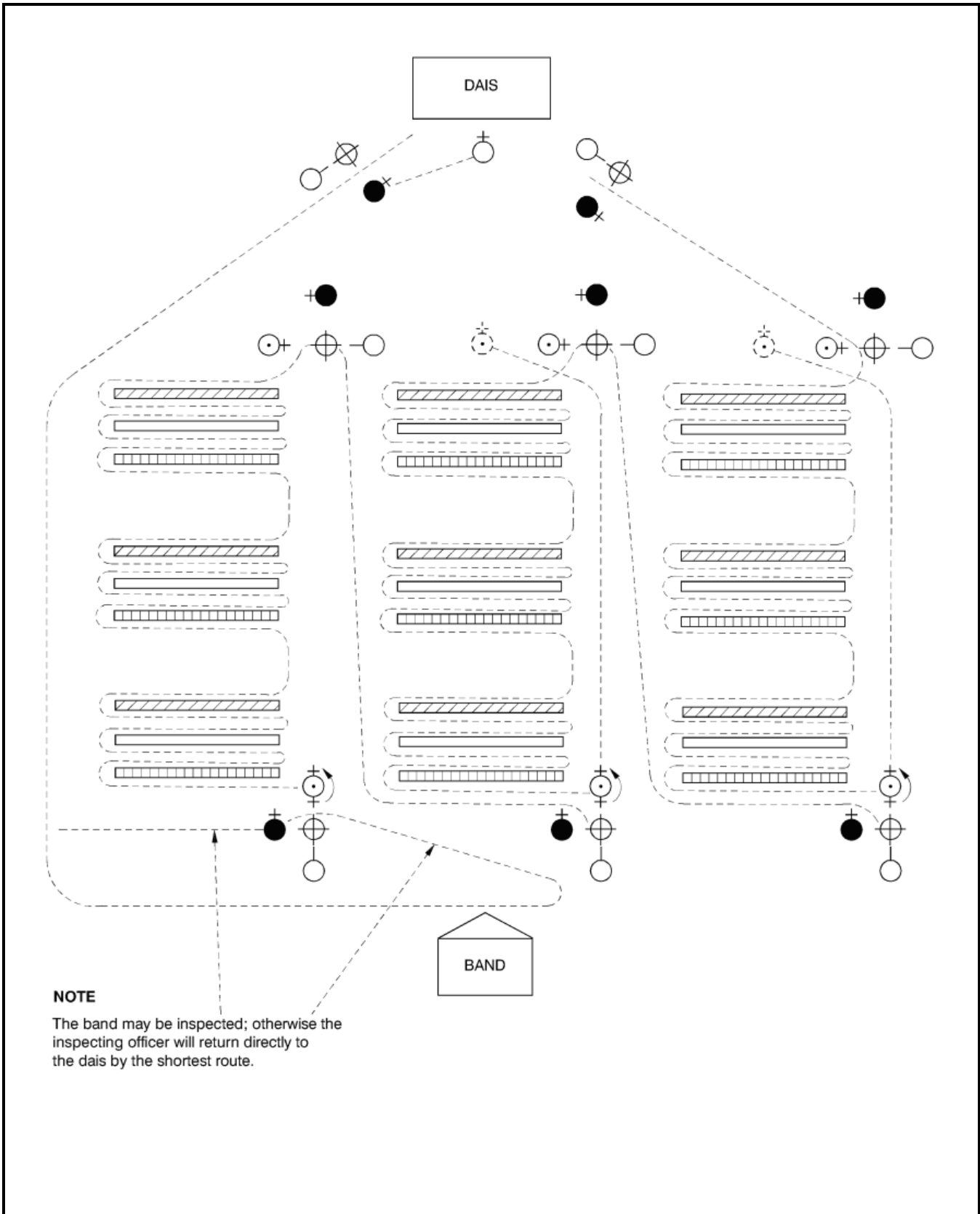

Figure 9-1- 2 Inspection of Battalion in Mass

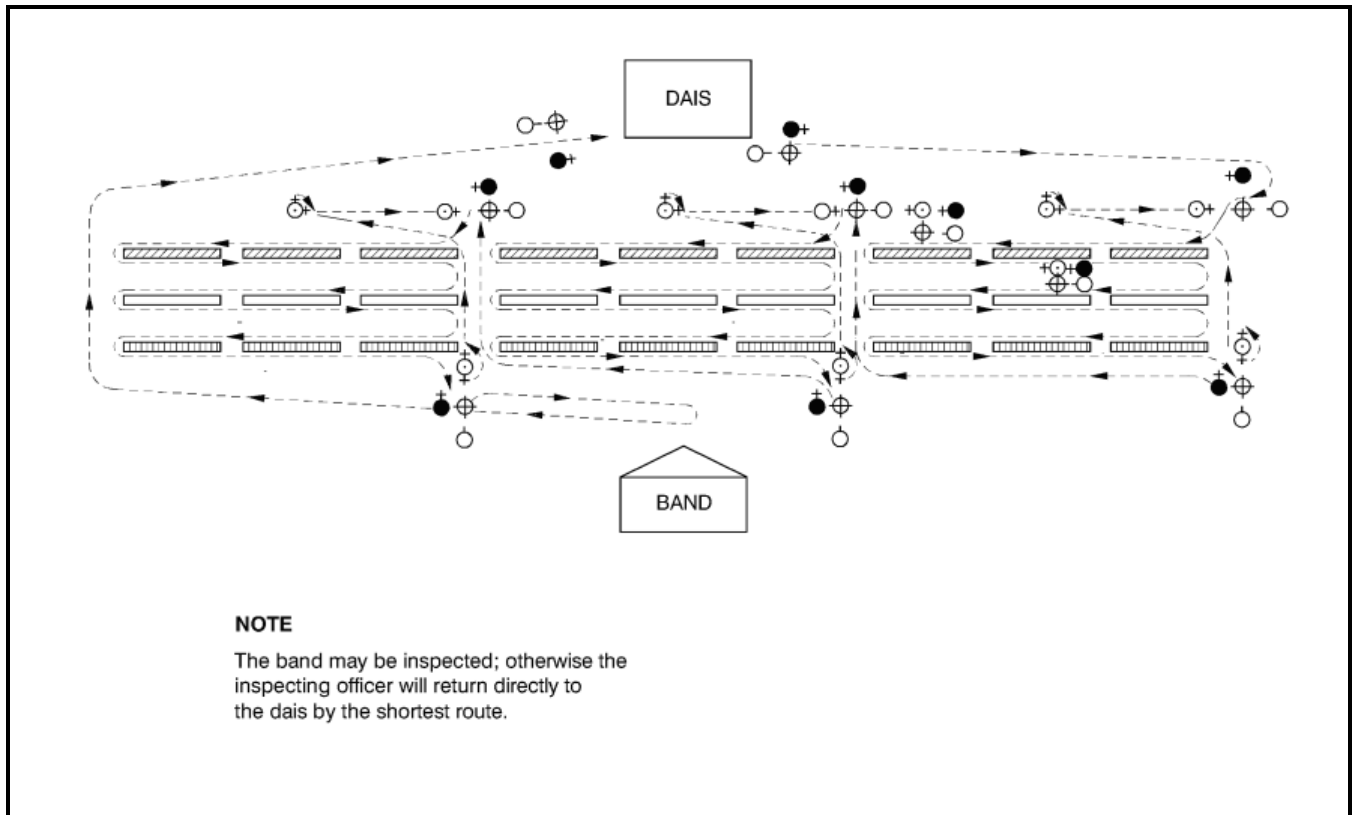

Figure 9-1-3 Inspection of Battalion in Line

BANDS

20. Some of the ceremonies in this publication include specific instructions for the employment of bands.
21. Bands provide the musical accompaniment and regular marching cadence essential to the most successful parades and ceremonial occasions. Band manoeuvre should complement the actions of other units on parade.
22. Bands are either an integral part of the unit or formation on parade or under the operational command of the parade commander. While bands respond to the verbal commands of the parade commander, they also act on the visual signals of their conductor or drum major, thus reducing the need for separate commands to the band.
23. The battalion commander should ensure that the band is instructed on the parade format in advance. The instructions should include requirements for special salutes or traditional unit music in sufficient time for the band to acquire and rehearse the music and drills.
24. When more than one band is present, the parade commander should consider massing/ combining the bands for best musical and visual effect or dispersing them along the column of troops. The parade commander is advised in the technical aspects of these matters by the senior director of music or bandmaster.

NOTE

When two bands are together on parade they are 'combined', when three or more bands are on parade together they are 'massed'.

25. Whenever possible, battalion reviews shall be attended by a band. Unless the form of the ceremony dictates otherwise, the band will lead the battalion on and off parade, be positioned in the centre rear or on a flank of the battalion on parade, and play:
 - a. the battalion onto and off of the parade ground;

- b. the correct musical salutes when compliments are paid to dignitaries;
- c. appropriate music for the inspection;
- d. appropriate music for the march(s) past;
- e. the music for the advance in review order; and
- f. other music commensurate with the ceremony.

26. The conductor and drum major shall salute when marching past a dignitary, although not while simply parading in front, e.g., when performing the band "troop" during a trooping of the Colours.

SECTION 2

THE BATTALION REVIEW

INTRODUCTION

1. A battalion review is a military ceremony held on such occasions as:
 - a. in honour of royal personages, senior officials and higher military commanders;
 - b. in conjunction with the consecration, presentation, trooping and laying up of Colours;
 - c. awards and presentations; and
 - d. changes of command.
2. The procedures outlined in this section for a battalion may be performed by a military unit or formation of any size.

SEQUENCE OF A BATTALION REVIEW

3. The sequence of a battalion review is:
 - a. the reception of the reviewing officer;
 - b. the inspection by the reviewing officer;
 - c. the march past;
 - d. presentations, if any;
 - e. the address by the reviewing officer;
 - f. the advance in review order; and
 - g. the departure of the reviewing officer.

REVIEW PARADE GROUND

4. The review parade ground shall be marked by flags or markers as illustrated in Figure 9-2-1 and see A-AD-200-000/AG-000, Honours, Flags and The Heritage Structure of the Canadian Forces soon to become A-DH-200-000/AG-000; The Heritage Structure of the CAF.
5. The inspection line is the line on which the front rank of the battalion is formed for inspection. The march past line is the line along which the right flank of the battalion marches during the march past. The advance line is the line at which the front rank of the battalion halts on completion of the advance in review order.
6. The length of the inspection line (G-H) depends on the frontage of the troops being inspected. Its distance from the march past line will include the greatest frontage occupied by any sub-unit when marching past, plus the depth occupied by the band or massed bands while playing the units past. Except in unusual circumstances (see paragraph 37), minimum distance from the march past line shall be 30 paces.
7. The length of the saluting base (B-E) will not be less than 120 paces nor greater than 260 paces, the distance being dependent on local conditions. The march past begins at Point B and ends at Point E. The reviewing officer will be located at the centre of the saluting base. Ten paces on each side of him, along the saluting base, are Points C and D, at which the salute will begin and finish respectively. If a march past is to take place without opening and closing order, i.e., in quick time only, Points B and E need not be marked (see paragraph 10), but Points A and F should still be located normally.

8. As a general rule, the march past line (A-F) will be the same length as the inspection line and be situated no less than five paces in front of the dais.

9. The advance line shall be the same length as the inspection line and normally be situated 15 paces forward of the inspection line (see paragraph 37).

10. All points shall be marked by flags, pennants or marker personnel. Flags may also be set up to mark the spot on which the troops are to form (Points 1 and 2) and the Inspection Line (Points G and H), or these locations may be marked by other means, e.g., chalk, whitewash, etc.

11. When large bodies of troops are to march past, it will usually be desirable to place small flags along the march past line to guide units in moving off and maintaining correct distances through to Point F.

12. Flags, appropriate to the occasion, may be flown in the vicinity of the dais see A-AD-200-000/AG-000, Honours, Flags and The Heritage Structure of the Canadian Forces soon to become A-DH-200-000/AG-000, The Heritage Structure of the CAF.

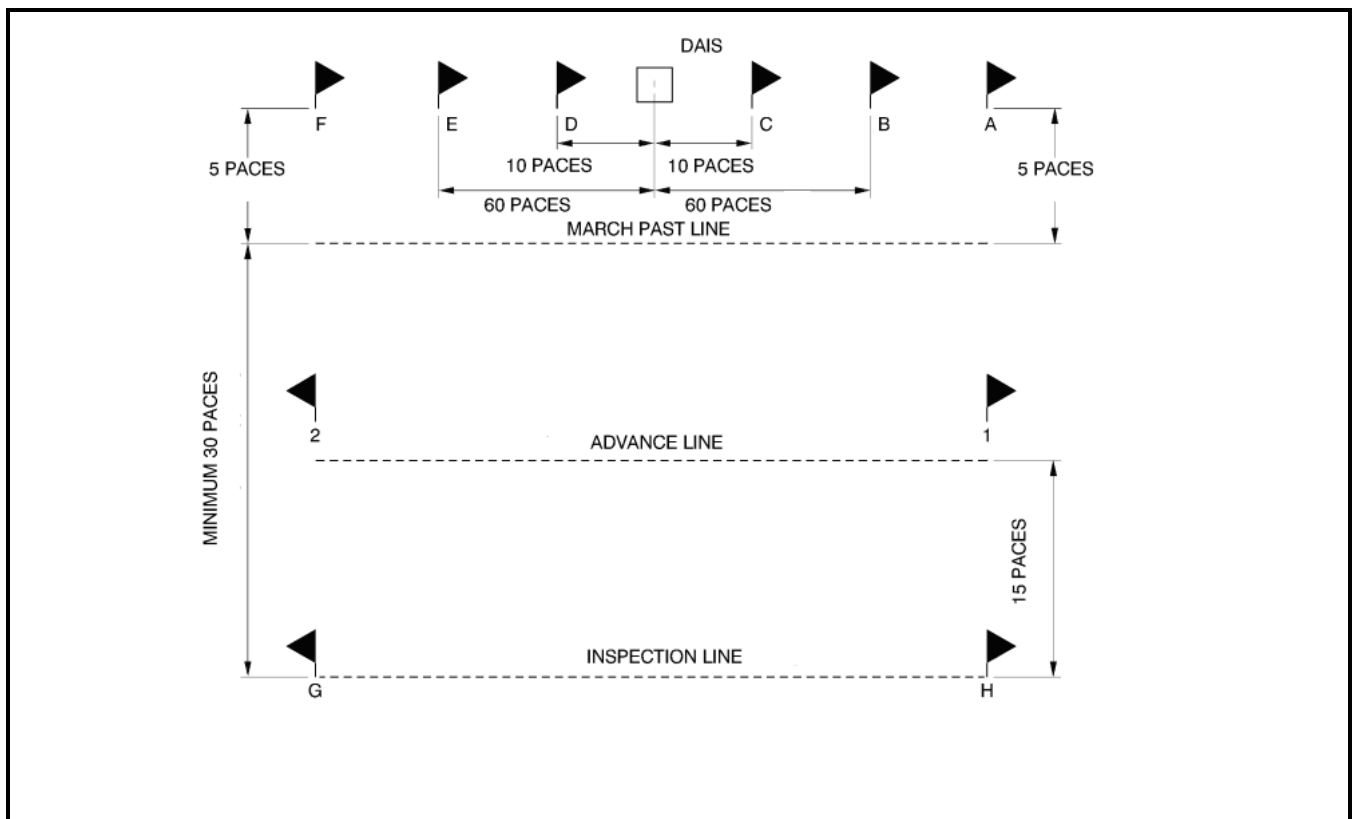

Figure 9-2- 1 Review Parade Ground

COMPLIMENTS AND REVIEW ORDER

13. All compliments to royal personages, senior officials and higher military commanders shall be paid in review order. In review order, the ranks are in open order and officers and Colours are forward in front of the body of troops. (Non-consecrated flags remain in place in the ranks.) See A-AD-200-000/AG-000, Honours, Flags and The Heritage Structure of the Canadian Forces soon to become A-DH-200-000/AG-000, The Heritage Structure of the CAF, Chapter 13.

14. For a battalion in line, review and normal order are the same, except that for review order the Colours are advanced in line with the platoon commanders (including the Guidons of armour regiments, which have the special privilege of being carried by warrant officers). If the circumstances permit, the Colours may be marched on parade directly into review order.

15. For a battalion in column, close column or mass, officers and Colours are ordered forward as follows: OFFICERS AND COLOURS WILL TAKE POST IN REVIEW ORDER, TAKE POST, QUICK – MARCH.

- a. On the word ORDER, Colours shall be brought to the carry.
- b. On the command MARCH, officers shall step off, wheeling immediately to their right, and move by the right flank of their companies to the front of the body of troops; officers already in front of the body of troops shall stand fast.
- c. On arrival, officers shall spread themselves evenly across the front of the leading company if in column, or leading platoon if in mass; Colours in the centre.

16. Officers and Colours are returned to their normal positions from review order by the command OFFICERS AND COLOURS WILL TAKE POST IN CLOSE COLUMN (etc.), TAKE POST, QUICK – MARCH. On the command MARCH, officers shall step off, wheeling immediately to their right, and return to their ordered positions. On arrival, Colours shall be brought to the order unless an inspection is to follow immediately.

17. Non-commissioned officers, including Colour escorts, stand fast and do not change their positions when the battalion adopts review order.

RECEPTION OF THE REVIEWING OFFICER

18. At the time ordered for the review, the battalion shall be formed at the open order, in review order, in mass, line, column or close column on the inspection line.

19. Guests should be seated before the battalion marches onto the parade ground or, for very senior dignitaries, accompany the reviewing officer. Under rare circumstances, a battalion might receive two parties of dignitaries, paying appropriate compliments to the senior member of each. For example, a battalion might first receive its Colonel of the Regiment so that he might be at the dais to greet the reviewing officer.

20. When the reviewing officer has taken his position on the dais, the commanding officer shall order the appropriate salute in accordance with Chapter 13 to see A-AD-200-000/AG-000, Honours, Flags and The Heritage Structure of the Canadian Forces soon to become A-DH-200-000/AG-000, The Heritage Structure of the CAF. If the reviewing officer is a distinguished civilian not listed in the table, the word of command will be (unit title) GENERAL SALUTE, PRESENT – ARMS. An appropriate eight bars of music may be played at the discretion of the commanding officer, chosen in the order of priority which follows:

- a. the General Salute;
- b. an appropriate excerpt from the official march of the formation/unit being inspected; or
- c. an appropriate excerpt from the official march of the formation/unit of the reviewing officer.

21. If rifles and carbines are not carried on parade, the word of command is ROYAL (GENERAL) SALUTE – SALUTE. The band plays the appropriate music and all officers on parade salute, cutting their arms to the side after a standard pause after the last note of music. If a band is not available, the salute is completed with a standard pause between movements or upon the order ATTEN – TION.

22. Upon termination of the salute and after the battalion has ordered arms, the commanding officer shall report to the reviewing officer that the battalion is ready for inspection. The commanding officer may request that the remainder of the parade be stood at ease while the reviewing officer inspects the first company. If permission is given, the commanding officer will turn about and give the appropriate order. If the battalion has received the reviewing officer in column or mass, officers and Colours shall be ordered to take post in that formation before inspection begins. The battalion commander will then turn and accompany the reviewing officer on the inspection.

INSPECTION

23. The reviewing officer, when not nearest the rank being inspected, shall be on the commander's right, e.g., when progressing to and from the battalion formation. When the reviewing officer inspects the battalion, the positions of the inspecting party are the:

- a. reviewing officer, nearest the rank being inspected;
- b. company commander, on the right of the reviewing officer;
- c. commanding officer, in rear of the reviewing officer; and
- d. aide-de-camp, in rear of the company commander.

24. Unless specifically requested, the reviewing officer shall not be preceded by anyone.

25. The reviewing officer normally will inspect the battalion by companies, accompanied by each company commander (see Section 1, paragraph 10). On a large parade, the reviewing officer may be accompanied by the commanding officer only, with the commanding officer on the reviewing officer's right. In this event, the whole battalion will remain at attention and inspections will be by rank across the complete frontage of the battalion. If the formation to be reviewed is extremely large or the reviewing officer has difficulty walking the distance, the inspection may be by open vehicle driven in front of the unit or units on parade.

26. The reviewing officer does not normally visit or inspect the band unless it is an integral part of the unit being reviewed.

27. On completion of the inspection and after the commanding officer has accompanied the reviewing officer to the dais, the commanding officer shall order the battalion to attention and request permission to march past in review.

MARCH PAST

28. The battalion may march past in column of route or in column or close column of companies, depending on the time and space available, the degree of training of the troops, and the formality of the occasion.

29. The simplest march past is in column of route in quick time.

30. In column or close column of companies, the march past may be in slow or quick time.

31. On the most formal of occasions, the battalion may march past twice, once in slow time in column or close column and once in quick time in column, close column or column of route.

32. Because of their traditions of agility and speed on the battlefield, rifle regiments, parading by themselves, march past in quick and double time at the trail arms.

33. Units will be in the formation ordered for the march past as they pass Point A in Figure 9-2-1; i.e., in column of companies, column of route, etc. The A-B portion of the march past line should be of sufficient length to enable units to obtain their dressing before reaching the saluting base. Units will move up to Point B in close order; at that point, if in slow time and so ordered, they will open order prior to marching past. Companies shall salute as they reach Point C and shall cease their salute as they clear Point D. Upon reaching Point E, units will close order, if required, and upon reaching Point F, may change their formation, if so ordered.

34. The procedures, commands and actions required to march past are those of standard platoon, company and battalion drill. They are outlined in:

- a. Table 9-2-1, for a march past in column of route; and
- b. Figure 9-2-2 and tables 9-2-2 and 9-2-3 for a march past in column or close column of companies.

PRESENTATIONS AND ADDRESSES

35. If presentations are to be made, they shall follow the march past.
36. Following any presentations, the reviewing officer may address the battalion. If the circumstances warrant, the commanding officer may make a short reply.

ADVANCE IN REVIEW ORDER

37. If the battalion was reformed in column (close column) of companies or in mass after the march past, officers and Colours will be ordered to take post in review order prior to advancing and paying final compliments to the reviewing officer (see paragraph 13).
38. On the command **ADVANCE IN REVIEW ORDER, BY THE CENTRE, QUICK – MARCH** by the commanding officer, the battalion advances 15 paces and halts automatically, completing all forward movement on the last pace, and then bending the right knee and assuming the position of attention.
39. In exceptional circumstances, where space does not permit the minimum 30 paces between the march past and inspection lines, a lesser advance may be specifically ordered, e.g., **ADVANCE IN REVIEW ORDER SEVEN PACES, BY THE CENTRE, QUICK – MARCH**. The front rank will always halt no closer than 15 paces from the march past line. If less than seven paces can be taken, there shall be no advance.
40. The commanding officer then orders the appropriate compliments.

DEPARTURE OF THE REVIEWING OFFICER

41. On completion of the salute the reviewing officer shall depart.
42. If the commanding officer wishes to depart with the reviewing officer, he shall do so only after calling forward the deputy commander and formally turning over command of the battalion.

No.	Command	By	Action	Remarks
			Upon receiving permission to proceed, the commanding officer (CO) shall salute, turn about and return to his command position. The CO shall then order CLOSE ORDER – MARCH and, if applicable, SHOULDER – ARMS. Thereafter, the CO will order BATTALION WILL MARCH PAST IN (SLOW AND) QUICK TIME.	
If Parade Formed in Mass, in Column or Close Column of Companies				
1	ADVANCE FROM THE RIGHT IN COLUMN OF ROUTE, "A" COMPANY LEADING, RIGHT – TURN	CO	Battalion turns right.	Officers, the chief warrant officer (CWO) and warrant officers take up position in column of route.
If Parade Formed in Mass				
1a	No. 1 PLATOON, BY THE LEFT, QUICK – MARCH	No. 1 PI Comd	No. 1 Platoon acts as ordered. Battalion and company officers formed up in advance of the platoon step off simultaneously and in time with the platoon.	Succeeding platoon commanders give the same command as for battalion drill.
If Parade Formed in Column or Close Column of Companies				
1b	"A" COMPANY, BY THE LEFT, QUICK – MARCH	"A" Coy Comd	"A" Company acts as ordered. Battalion officers formed up in advance of the company step off simultaneously and in time with the company.	Succeeding company commanders give the same command as for battalion drill.
If Parade Formed in Line				
2	MOVE TO THE RIGHT IN COLUMN OF ROUTE, RIGHT – TURN	CO	Battalion acts as ordered.	In accordance with Item 1.
2a	BATTALION, BY THE LEFT, QUICK – MARCH	CO	The battalion acts as ordered.	

Table 9-2- 1 (Sheet 1 of 4) March Past in Column of Route

No.	Command	By	Action	Remarks
3			At the first suitable point past point H, the CO wheels left and the battalion follows. Upon reaching the march past line, the CO wheels left and leads the battalion along the line.	
4	BY THE RIGHT	CO	The master warrant officers (MWO) (Right Markers) shall move to the right flank and lead the rear ranks of their companies along the march past line.	Given after the CO has completed the wheel.
5	IN SUCCESSION OF COMPANIES, EYES – RIGHT	CO		Given at Point B
6	IN SUCCESSION OF PLATOONS, EYES – RIGHT	"A" Coy Comd	CO and Adjutant (Adjt) salute, CWO turns head and eyes to the right.	"A" Company Commander (Coy Comd) ensures command given as CO reaches Point C.
7	NO. 1 PLATOON, EYES – RIGHT	No. 1 PI Comd	Coy Comd and platoon commander (PI Comd) salute, platoon turns heads and eyes to the right.	MWO maintains head and eyes to the front guiding No. 1 Platoon on march past line. PI Comd ensures command given as "A" Coy Comd reaches Point C. Each succeeding Coy and PI Comd repeats these commands. Platoons act as ordered.
8	IN SUCCESSION OF COMPANIES, EYES – FRONT	CO		Given after passing dais.
9	IN SUCCESSION OF PLATOONS, EYES – FRONT	"A" Coy Comd	CO and Adjt cease salute, CWO turns head and eyes to the front.	Given as CO, Adjt, and CWO have reached Point D.

Table 9-2-1 (Sheet 1 of 4) March Past in Column of Route

No.	Command	By	Action	Remarks
10	NO. 1 PLATOON, EYES – FRONT	No. 1 PI Comd	“A” Coy Comd and PI Comd cease salute, platoon turns heads and eyes to the front.	Given as the whole of platoon has passed Point D. PI Comds will know their platoon frontage and the number of paces required.
11	BY THE LEFT	CO	CO wheels left at Point F, battalion follows.	Given just as wheel started by CO. Upon reaching Point G. CO wheels left leading battalion onto the inspection line.
If Parade is to be reformed in Mass				
12	ON “A” COMPANY, FORM – MASS	CO		Given as CO approaches centre of inspection line. CO wheels left and proceeds to his command position. Battalion continues along inspection line.
12a	“A” COMPANY, AT THE HALT, FACING LEFT, FORM COLUMN (CLOSE COLUMN) OF – PLATOONS	“A” Coy Comd		Given as “A” Company approaches original position.
12b	NO. 1 PLATOON – HALT	No. 1 PI Comd	No. 1 Platoon halts.	The remainder of the company proceed to form column or close column as for company drill. Remaining companies and platoons follow the same procedure at their original positions.
If Parade is to be Reformed in Column (Close Column) of Companies				
13	AT THE HALT, FACING LEFT, FORM COLUMN (CLOSE COLUMN) OF COMPANIES	CO		As for No. 12.

Table 9-2-1 (Sheet 1 of 4) March Past in Column of Route

No.	Command	By	Action	Remarks
13a	"A" COMPANY – HALT	"A" Coy Comd	"A" Coy halts.	CWO paces off column (close column) distance. "B" and "C" companies wheel and form column of companies as for battalion drill.
After Halting in Mass or Column (Close Column) of Companies				
14	"A" COMPANY ADVANCE, LEFT – TURN	"A" Coy Comd	"A" Coy turns left.	"B" and "C" Coy Comds advance their company's in succession. On "C" Coy Comd's executive word of command, the three Coy Comds turn about together.
If Parade is to Reform in Line				
15	"A" COMPANY, MARK – TIME, BATTALION – COVER	CO	"A" Company marks time, remainder continue forward until arrival at original position and then mark time.	If battalion is experienced at maintaining proper distance, only the command HALT need be given as the battalion arrives at its original position.
15a	BATTALION – HALT	CO	Battalion halts.	
15b	BATTALION ADVANCE, LEFT – TURN	CO	Battalion turns left.	

Table 9-2-1 (Sheet 1 of 4) March Past in Column of Route

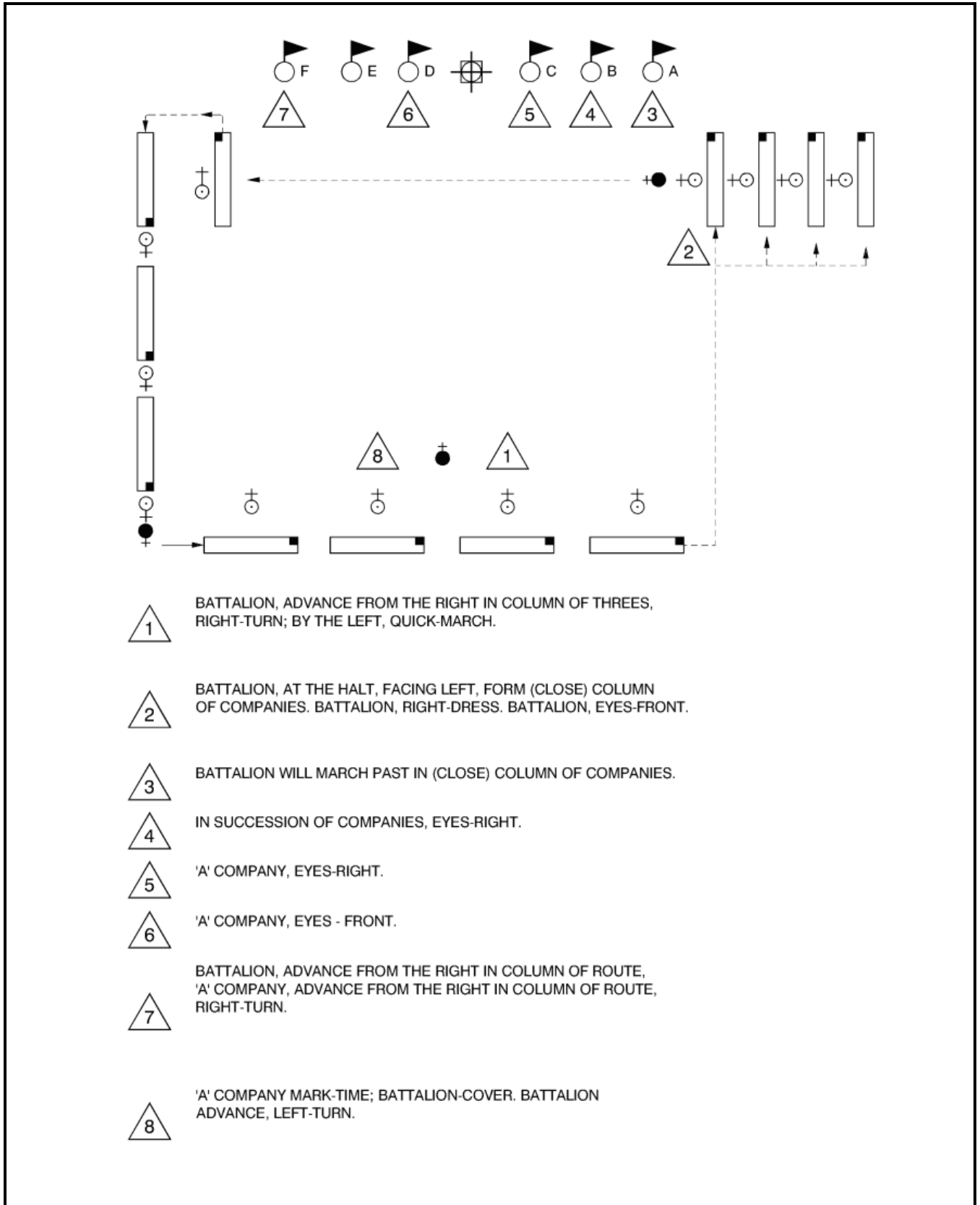

Figure 9-2- 2 March Past in (Close) Column of Companies in Quick Time

No.	Command	By	Action	Remarks
<p>If the battalion intends to march past in column (close column) of companies, it will be formed up for review in either line, column or close column, and not in mass, with each company formed and sized as a single formation (as for one large platoon). See Figure 9-2-2 for an illustration of this procedure. The march past will commence as in Table 9-2-1, but in column of threes, until completion of Item 2. Thereafter:</p>				
3				On stepping off or at the first suitable point past Point H, CO orders a left wheel.
4	BATTALION, AT THE HALT, FACING LEFT, FORM COLUMN (CLOSE COLUMN) OF COMPANIES	CO		Given as CO approaches Point A.
5	"A" COMPANY – HALT	"A" Coy Comd	"A" Company halts at Point A, on the march past line.	CWO paces off (close) column distance. "B" and "C" Companies wheel and form column of companies as for battalion drill.
6	"A" COMPANY ADVANCE, LEFT – TURN	"A" Coy Comd	"A" Company turns left.	"B" and "C" Coy Comds advance their companies in succession. On "C" Coy Comd's executive word of command, the Coy Comds turn about together.
7	BATTALION, RIGHT – DRESS	CO	Battalion acts as ordered.	
8	RIGHT FLANK – STEADY	CWO	As per battalion drill.	MWOs dress front, centre, and rear ranks as per battalion drill.
9	BATTALION, EYES – FRONT	CO	Battalion acts as ordered.	CO turns about, facing the front.

Table 9-2- 2 (Sheet 1 of 3) March Past in Column (Close Column) of Companies in Quick Time

No.	Command	By	Action	Remarks
10	BATTALION WILL MARCH PAST IN (CLOSE) COLUMN OF COMPANIES	CO		If the battalion is in the formation ordered, the CO will order QUICK – MARCH. If, because of space limitations, the battalion is in close column and the march past is to be in column, Coy Comds will order QUICK – MARCH as per No. 11.
11	“A” COMPANY BY THE RIGHT, QUICK – MARCH	“A” Coy Comd	“A” Company steps off in quick time.	As “A” Coy reaches column distance, “B” Coy Comd gives same command, followed by “C” Coy when “B” Coy has reached column distance.
12	IN SUCCESSION OF COMPANIES, EYES – RIGHT	CO		Given at Point B.
13	“A” COMPANY, EYES – RIGHT	“A” Coy Comd	CO, Adj, and company officers salute; CWO looks to the front; MWO and remainder turn head and eyes to the right.	Given as CO reaches Point C. “B” and “C” Coy Comds give same orders to the right at Point C. MWO’s of “B” and “C” Coy look to the front.
14	IN SUCCESSION OF COMPANIES, EYES – FRONT	CO		Given at Point D.

Table 9-2-2 (Sheet 1 of 3) March Past in Column (Close Column) of Companies in Quick Time

No.	Command	By	Action	Remarks
15	"A" COMPANY, EYES – FRONT	"A" Coy Comd	CO, Adj, and company officers cease salute; MWO and remainder look to the front.	Given as company clear of Point D. "B" and "C" Coy Comds give same command, once clear of Point D.
16	BATTALION, ADVANCE FROM THE RIGHT IN COLUMN OF ROUTE	CO		Given prior to reaching Point F. (If in close column, companies must halt or open to column distance on the march after Point E prior to turning right.)
17	"A" COMPANY, ADVANCE FROM THE RIGHT IN COLUMN OF ROUTE, RIGHT – TURN	"A" Coy Comd	"A" Company executes a right turn, followed by two successive left wheels to follow the CO, who wheels toward the inspection line.	Executed at Point F. Officers and platoon warrant officers take up position as for column of route. "B" and "C" Coy Comds give same command at Point F, and follow route of "A" Coy.
18				Upon reaching Point G, CO wheel left, and the battalion follows. The battalion will be reformed on the inspection line in the same manner as detailed in Table 9-2-1.

Table 9-2- 2 (Sheet 1 of 3) March Past in Column (Close Column) of Companies in Quick Time

No.	Command	By	Action	Remarks
<p>If the battalion intends to march past in (close) column of companies in both show and quick time, it will be formed up for review in either line, column or close column, and not in mass, with each company formed and sized as a single formation (as for one large platoon). The march past will commence as in Table 9-2-2 until completion of Item 9. Thereafter the CO will order the sequence in his cautionary command.</p>				
10	BATTALION WILL MARCH PAST IN COLUMN OF COMPANIES, IN SLOW AND QUICK TIME, "A" COMPANY LEADING	CO		
11	"A" COMPANY, BY THE RIGHT, SLOW – MARCH	"A" Coy Comd	"A" Company acts as ordered.	As "A" Company reaches column distance, "B" Coy Comd gives same command, followed by "C" Company, when "B" Company has reached column distance.
12	"A" COMPANY, OPEN – ORDER	"A" Coy Comd	Coy acts as ordered.	Given at Point B. Remaining companies also open order at Point B.
13	IN SUCCESSION OF COMPANIES, EYES – RIGHT	CO		Given immediately after "A" Company completes the open order.
14	"A" COMPANY, EYES – RIGHT	"A" Coy Comd	CO, Adj, and company officers salute; CWO looks to the front; MWO and remainder turn head and	Given as CO reaches Point C. "B" and "C" Coy Comds give same commands so companies are looking to the right at Point C. MWO's of "B" and "C" Company look to the front.
15	IN SUCCESSION OF COMPANIES, EYES – FRONT	CO		Given at Point D.

Table 9-2- 3 (Sheet 1 of 3) March Past in Column (Close Column) in Slow and Quick Time

No.	Command	By	Action	Remarks
16	"A" COMPANY, EYES – FRONT	"A" Coy Comd	CO, Adjt and company officers cease salute, MWO and remainder look to the front.	Given as company clear of Point D. "B" and "C" Coy Comds give same command, once clear of Point D.
17	"A" COMPANY, CLOSE – ORDER	"A" Coy Comd	"A" Company acts as ordered.	Given at Point E, "B" and "C". Coy Comds give same command at Point E.
18	"A" COMPANY, – CHANGE DIRECTION LEFT, LEFT – FORM	"A" Coy Comd	"A" Company acts as ordered.	Given at Point 2. "B" and "C" Coy Comds give same command on arriving at Point 2.
19	"A" COMPANY FOR – WARD	"A" Coy Comd	"A" Company acts as ordered.	"B" and "C" Coy Comds give same command after their companies have completed the left form.
20		Coy Comds		Nos. 18 and 19 are repeated at Point G. When "C" Company has stepped off, CO orders:
21	BATTALION, CHANGE TO QUICK TIME, QUICK – MARCH	CO	Battalion acts as ordered.	CO moved to original position following Item 20, so as to be able to observe "C" Company's movements. Following Item 21, CO takes shortest route to command position in front of "A" Company.

Table 9-2-3 (Sheet 2 of 3) March Past in Column (Close Column) in Slow and Quick Time

No.	Command	By	Action	Remarks
22		Coy Comds		Nos. 18 and 19 are repeated at Points H and I in quick time.
23	IN SUCCESSION OF COMPANIES, EYES – FRONT	CO		Given at Point B. The parade then continues as per Table 9-2-2.

NOTES

If the battalion is very highly trained and practised in ceremonial, it may carry out the entire march past in column. In this event, the companies must be sized before forming up so that each has the same frontage. After the inspection, the battalion:

- a. if in column, moves to the right in threes, advances in column after passing Point G, forms at Point 1, and continues to march past without a halt as in this table; and
- b. if in line, either:
 - (1) proceeds as in sub-paragraph a. above, or
 - (2) forms column at the halt facing the original right flank (the CO orders: CLOSE ORDER – MARCH; RETIRE, ABOUT – TURN; AT THE HALT, RIGHT – FORM; QUICK – MARCH; and ADVANCE, ABOUT – TURN [LEFT – DRESS; EYES – FRONT]), advances in slow time; left forms at Point H; and then proceeds as in sub-paragraph a. above.

Table 9-2-3 (Sheet 3 of 3) March Past in Column (Close Column) in Slow and Quick Time

CHANGE OF COMMAND PARADES

43. Although a change of command can be a simple office signing ceremony, a battalion review may be held to mark the occasion.

44. The presiding officer, normally the senior formation commander, is the reviewing officer.

45. It has become customary to vary the normal review procedures as follows if a change of command is to take place on parade:

- a. the incoming commanding officer arrives with the reviewing officer and accompanies him as part of the inspection party;
- b. the battalion marches past once and reforms on the inspection line;
- c. presentations, certificate signing and addresses take place:
 - (1) first, any presentations to other than the outgoing commanding officer,
 - (2) second, the outgoing commanding officer addresses his unit for the final time,
 - (3) third, the change of command certificates are signed (see paragraph 46), followed by any presentation, such as a battalion camp flag or pennant, etc., to the outgoing commanding officer, and
 - (4) last, an address is made by the reviewing officer, with the incoming commanding officer making a short reply to both addresses if circumstances warrant;
- d. the battalion, under the incoming commanding officer, marches past the outgoing commanding officer;
- e. the battalion advances in review order and pays departing compliments to the reviewing officer; and
- f. the reviewing officer departs, accompanied by the outgoing commanding officer.

46. For the signing ceremony, the presiding officer, accompanied by the incoming commander, takes up a position in front of the dais. The outgoing commanding officer proceeds forward and halts in front of the presiding officer, and the outgoing commanding officer salutes. If the unit Colours are on parade, and if unit custom so dictates, the outgoing commanding officer may order the Colour bearers to advance with him. If so, following the salute, the bearers hand the Colours to the outgoing commanding officer (Queen's Colour first) who, in turn, hands them to the incoming commanding officer, signifying the transfer of command. The incoming commanding officer, in turn, hands the Colours back to the bearers. The bearers face the inspection line and, on the incoming commanding officer's orders, take posts back in the battalion. The incoming and outgoing commanding officers next proceed to a table placed at one side of the dais and sign the change of command certificates, under the supervision of the presiding officer.

SECTION 3

TROOPING THE COLOUR

GENERAL

1. The ceremony of trooping the Colour is a very formal parade, normally held at least once each year to permit all members of a unit to view their Colours, which symbolize pride, honour and devotion to Sovereign and country.
2. During the trooping ceremony, the right flank company is traditionally referred to as the "Escort for the Colour" until the Colour is received, following which it is referred to as the "Escort to the Colour" (see also Section 1, paragraph 3).
3. Where only one Colour is mentioned in this section, it may be interpreted to mean two, for units with a stand of Colours (see also paragraph 15 and Annex B).
4. When the band is mentioned in this section, it is understood to include a corps of drums or a massed band and drums, if available.

PARADE SEQUENCE

5. A trooping follows the same general sequence as a battalion review (see Section 2), with the following variations from normal procedure.
6. The companies shall be sized by attachments and detachments so that each has the same frontage, and paraded as single sub-units (as if each was one large platoon with right and left markers).
7. The battalion shall form up in two ranks and in line on the inspection line. There shall be no interval between companies.
8. The band shall be positioned on the right front of the parade ground, facing inwards toward the left flank. If a corps of drums (bugles, piper and drums) is also present, it shall march on massed with and leading any brass-reed band, wheeling separately to cross the parade square from the band's position, counter-marching in front of the Colour, and halting, facing inwards, when its rear rank is ten paces in front of the Colour.
9. The Colour, guarded by sentries (see paragraph 14), shall be positioned on the left front of the parade ground, near Point F, a distance of one half of the Escort for the Colour's frontage from the march past line (Figure 9-3-1).
10. The inspection shall be of the battalion as a whole, rather than by companies.
11. After the inspection, the Colour shall be trooped as detailed in paragraph 19. The Colour party shall then remain with the Escort to the Colour until after the march past.
12. The march past shall be in slow and quick time in column of companies, the Colour party taking post in rear of the Escort to the Colour. Because of the formality of the occasion, if space allows the battalion should form column of companies on the inspection line and complete the march past smoothly with no halts (see Table 9-2-3, Note b. (2)).
13. When the battalion is dressed after the completion of the march past, the Colour party shall move to its normal position on parade in review order.
14. Thereafter, the normal review procedure will be followed.

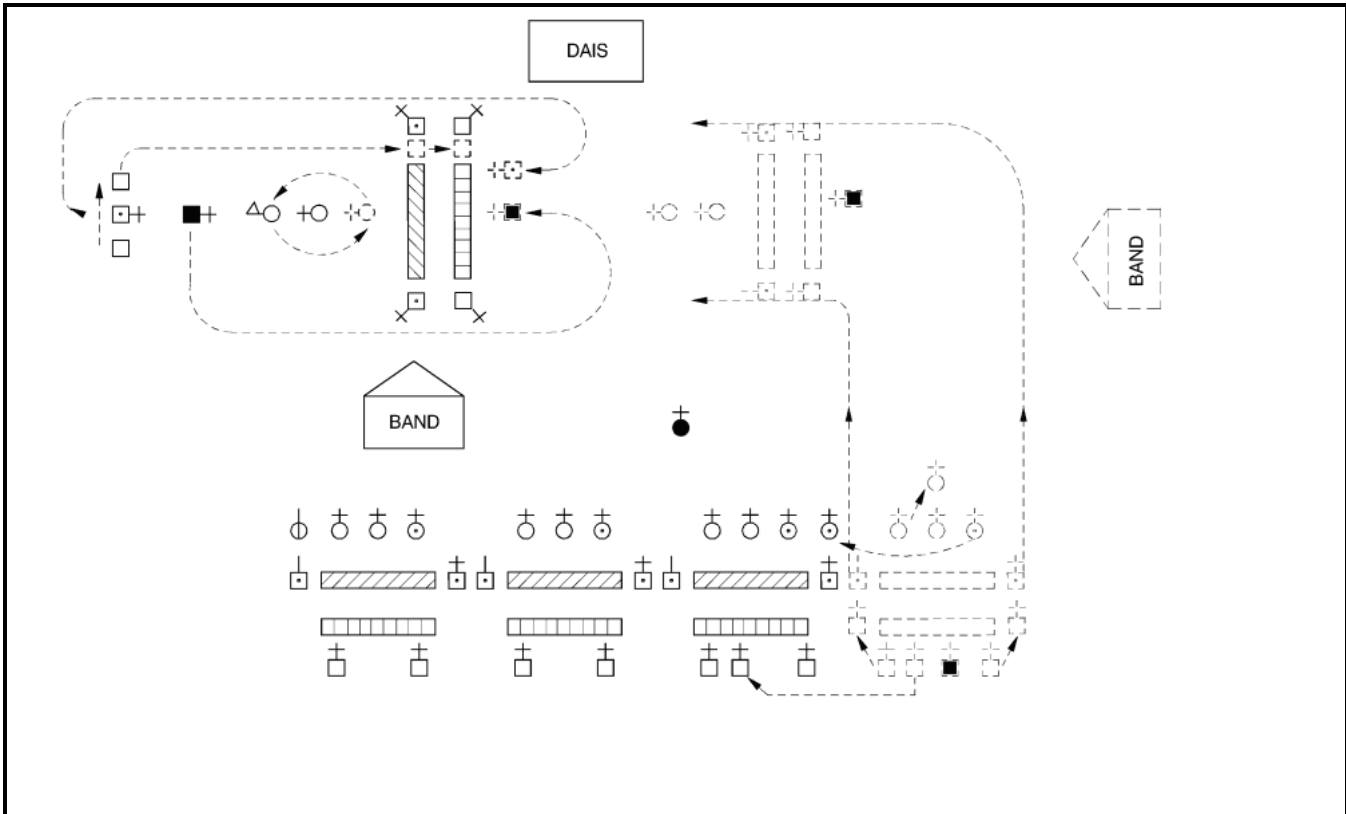

Figure 9-3-1 The Escort Receiving the Colour

15. As noted in Section 1, if the circumstances dictate, the parade commander may vary or elaborate these procedures. An example of such a variation is detailed in Annex B.

POSITIONING THE COLOUR PARTY

16. Prior to the trooping, the Colour officers shall parade with the Escort for the Colour and be replaced by non-commissioned officers from the same escort.

17. The Colour party shall march onto the parade ground, with bayonets fixed and the Colours cased at the slope. The Colour orderlies shall be unarmed and will cover off the Colour party from the rear. On halting in the position selected, the Colours shall be uncased as noted in Chapter 8.

18. After the Colours have been uncased, the Colour escorts, acting as sentries, shall commence patrolling a beat of ten paces (see Chapter 10) until the arrival of the reviewing officer. They shall then cease patrolling at their stations and present arms with the battalion on the command ROYAL (GENERAL) SALUTE, PRESENT – ARMS. From this point, unless specific exception is made, the sentries shall carry out all movements given at the halt, in time with the battalion.

TROOPING THE COLOUR

19. Upon completion of the inspection of the line, the commanding officer will escort the reviewing dignitary back to the dais. Once the reviewing dignitary is in position on the dais, the commanding officer shall salute and request permission to carry on with the ceremony. When permission is granted, the commanding officer shall salute, turn about and resume his command position 15 paces in front and centre of the line, face the dais and give the orders in Table 9-3-1.

20. Two elements of the trooping shall always occur, no matter what the circumstances:
 - a. the dispatch of the Escort for the Colour to receive the Colour, symbolizing the removal of the Colour from its lodging and its escort to the battalion; and
 - b. the troop through the ranks in slow time to show the Colour to all members of the battalion. This is the purpose and focal point of the ceremony.

No.	Command	By	Action	Remarks
1	TROOP	CO	The band shall play three drum beats and the initial chord of the selected "troop" march, and then march from the right to the left of the line, playing the slow march. On arriving 10 paces from the Colour, the band will counter march, halt, and cease playing. The band (and drums if present) shall then march from the left to the right of the line playing a quick march. On reaching their position in front of the right of the line, they shall counter march, halt and cease playing once again.	Although "Les Huguenots" and "The Colours" are the most common slow troop marches selected, unit commanders may select any suitable slow and quick march. As the drums approach the right of the line, before counter marching a selected drummer will fall out and march to a position two paces to the right of the front rank of the escort. On the band ceasing to play, this drummer shall beat the "Drummer's Call"
2	The "Drummer's Call" is sounded	Drummer	On the first tap of the call, the escort commander and officers of the escort, less the officer for the Colour, shall turn left, recover swords, and step off in quick time. Passing in rear of the officer for the Colour and any other officers as necessary, all escort officers except the senior lieutenant shall march to spread themselves evenly three paces in front of the second company, with the escort commander in front of the right file of that company. The lieutenant shall move to three paces in front of the officer of the Colour, who is situated in the centre of the escort. Simultaneously, the commanders of other companies shall turn right, recover swords, and, by a series of wheels, position themselves in the line of their company officers, three paces in front of their front ranks.	The drummer, on completion of the call, shall rejoin the band moving in quick time. If space and time permit, the drum major may wheel the band to the left in quick time and position it, by counter marching, in front of the escort. The CWO shall turn right and march to a position three paces in rear of the centre file of the escort and draw his sword. The flanking non-commissioned officers in the supernumerary rank in rear of the escort move up to the rear rank to cover the left and right markers and act as right and left rear markers. Any additional non-commissioned officers in the supernumerary rank turn left and step off in time with their officers to spread themselves evenly across the supernumerary non-commissioned officer rank of the second company.

Table 9-3- 1 (Sheet 1 of 6) Trooping the Colour

No.	Command	By	Action	Remarks
3	ESCORT FOR THE COLOUR, SHOULDER – ARMS	CO	The escorts act as ordered.	
4	REMAINDER, STAND AT – EASE	CO	The remainder of the battalion acts as ordered.	The Colour party shall remain at attention, at the order.
5	ESCORT FOR THE COLOUR, CLOSE ORDER – MARCH	Lt of the Escort	The escort acts as ordered.	
6	ESCORT FOR THE COLOUR, BY THE LEFT, QUICK – MARCH	Lt of the Escort	The escort acts as ordered, preceded by the band playing a quick march.	See Figure 9-3-1. As the band arrives opposite the Colour party it will wheel, centred on the Colour, and advance toward the left flank.
7	ESCORT FOR THE COLOUR, CHANGE DIRECTION LEFT, LEFT – FORM	Lt of the Escort	The escort acts as ordered.	Command given when escort is opposite the Colour, to bring the escort into line, facing left, centred on the Colour.
8	FOR – WARD	Lt of the Escort	The escort acts as ordered.	
9	BY THE CENTRE	Lt of the Escort	The escort taking dressing as ordered.	Given immediately after the command No. 8. The band, when near the Colour, shall wheel left, clear space for the escort, cease playing, halt, and turn about. On the escort reaching a position 20 paces from the Colour, the Lt shall order:

Table 9-3-1 (Sheet 2 of 6) Trooping the Colour

No.	Command	By	Action	Remarks
10	ESCORT FOR THE COLOUR – HALT	Lt of the Escort	The escort halts.	
11	ESCORT FOR THE COLOUR, OPEN ORDER – MARCH	Lt of the Escort	The escort acts as ordered.	
12	ESCORT FOR THE COLOUR, RIGHT – DRESS	Lt of the Escort	The escort shall dress by either full-arm or shoulder-to-shoulder dressing according to the dressing prescribed for the companies in the line.	The right marker shall remain in his position and, after a sufficient pause to allow the escort to complete its dressing, he shall order:
13	ESCORT FOR THE COLOUR, EYES – FRONT	Escort's Right Marker	The escort turn their heads and eyes to the front.	
14	BATTALION, ATTENTION	CO	The remainder of the battalion acts as ordered.	
15	BATTALION, SHOULDER ARMS	CO	The remainder of the battalion acts as ordered.	The sentries attending the Colour shoulder arms.
16	As shown in Figure 9-3-1 the CWO shall march in quick time to the front, passing the escort on its left, and halt two arms length distance from and facing the Colour. The CWO shall then salute the Colour and, upon completion of the salute, will take a half pace forward and receive the Colour into his left hand from the Colour MWO who, with a crisp motion of the right arm, hands the Colour to the CWO. With a similar motion of the left arm, the CWO shall receive the Colour and lower it to the carry position as for sword drill. The CWO shall turn about.			
17	The officer for the Colour marches forward in time with the CWO to a position four paces in front of the Lt of the escort, passing by the latter's right. After turning about, the CWO marches forward and halts two arm lengths from the officer for the Colour. The officer for the Colour shall salute the Colour and return his sword to its scabbard. The CWO takes half pace forward and simultaneously, with a sharp crisp movement of the left arm, thrust the Colour up and into the hands of the officer for the Colour. The officer of the Colour, with a similar motion of both arms, takes control of the Colour and adopts the carry position in accordance with Colour drill. The officer, now the Colour officer, will ensure that the Colour is properly dressed, and then shall turn about, the CWO stepping back half a pace.			

Table 9-3-1 (Sheet 3 of 6) Trooping the Colour

No.	Command	By	Action	Remarks
18	ESCORT TO THE COLOUR, PRESENT – ARMS	Lt of the Escort	Escort, including the Colour MWO officer and Colour escorts, shall present arms and the Lt of the escort and the CWO shall salute with their swords.	The right and left markers shall make an incline outwards, porting arms on the first movement of the present. The rear rank markers, (left and right) shall make three-quarters of an about turn outwards porting arms and turning on the first movement of the present. The band shall play the appropriate salute.
19	ESCORT TO THE COLOUR, SHOULDER – ARMS	Lt of the Escort	The escort, including the Colour MWO and Colour escorts shall shoulder arms. The Lt of the escort and the CWO carry swords.	The right and left markers shall make an incline to the front, shouldering arms, and turning on the first movement of the shoulder. The rear rank markers, (right and left) shall make three-quarters of an about turn back to their front, shouldering arms, and turning in time with the markers.
20	When the shoulder arms has been completed, the Colour officer shall resume his post in the rear of the Lt of the escort, passing right shoulder to right shoulder. The CWO shall take post in rear, passing by the left flank of the escort. The master warrant officer, who previously had held the Colour, turns left, with the sentries, and passes by the right flank and positions himself three paces in the rear of the third file from the right. As the sentries turn left, the right marker and the covering non-commissioned officer simultaneously take two side paces to the right, in order to provide space for the sentries and the band turns about. The sentries will march directly to the right file opening, halt, and turn about together. Once all are in place:			
21	ESCORT TO THE COLOUR, CHANGE DIRECTION LEFT, LEFT – FORM	Lt of the Escort	The escort acts as ordered.	

Table 9-3-1 (Sheet 4 of 6) Trooping the Colour

No.	Command	By	Action	Remarks
22	ESCORT TO THE COLOUR, SLOW – MARCH	Lt of the Escort	The escort acts as ordered.	The band, preceding the escort, shall play a slow march.
23	ESCORT TO THE COLOUR, FORWARD, BY THE CENTRE	Lt of the Escort	The escort steps off in slow time.	When the band reaches the left of the line, it shall wheel left, move in front of the line of officers, and, when clear of the escort's left flank, halt. The CO will move forward to make room for the band.
24	ESCORT TO THE COLOUR, MOVE TO THE RIGHT IN FILE, RIGHT – TURN	Lt of the Escort	The escort acts as ordered.	Given as the Lt of the escort reaches a point just in front of the line of officers.
25	LEFT – WHEEL	Lt of the Escort	The escort wheels left.	Given immediately after the right turn.
26	LEFT – WHEEL	Lt of the Escort	The escort wheels left.	Given as the leading file of the escort arrives opposite the front rank of the line. The band will cease playing as command is given.
27	BATTALION, PRESENT – ARMS	CO	The remainder of the battalion acts as ordered. The Colour officer shall let the Colours fly on the final movement of the present.	Given immediately after the second left wheel (No. 26).
28	BAND (AND DRUMS) SLOW – MARCH	Drum Major	The band steps off in slow time.	Command is normally given by mace signal.
29	The Lt of the escort shall move three paces in front of the line of officers, abreast of the second file from the right of the escort. The Colour officer will follow him abreast of the centre of the escort. The front rank of the escort will file between the front and rear ranks of the battalion, the rear rank of the escort passing between the rear and supernumerary ranks.			

Table 9-3-1 (Sheet 5 of 6) Trooping the Colour

No.	Command	By	Action	Remarks
30	When the escort reaches the right of the line, the right marker shall lead the front rank of the escort into line with the front rank of the battalion, and the leading non-commissioned officer of the escort's rear rank shall lead that rank into line with the rear rank of the battalion. As the head of the escort passes, the escort Commander, other escort officers and any supernumerary non-commissioned officers will carry (shoulder) their weapons, turn right and rejoin the escort in their original positions; the Lt of the escort will mark time as necessary at his original position, with other officers passing the left of the Lt of the escort. When the escorts has just cleared the line of companies, the Lt shall order:			
31	ESCORT TO THE COLOUR – HALT	Lt of the Escort	The escort shall halt.	The band shall cease playing approximately six paces prior to the escort being halted and continue on in slow time to their original position by wheeling.
32	ESCORT TO THE COLOUR, ADVANCE, LEFT – TURN	Lt of the Escort	The escort acts as ordered.	
33	ESCORT TO THE COLOUR – LEFT – DRESS	Lt of the Escort	The escort should dress on the second company.	The left marker stands fast. The escort's dressing will not be adjusted by the MWO. Officers will turn their heads left and dress on the officers of the second company.
34	ESCORT TO THE COLOUR, EYES – FRONT	Lt of the Escort	The escort acts as ordered.	
35	ESCORT TO THE COLOUR, PRESENT – ARMS	Escort Comd	The escorts acts as ordered.	
36	BATTALION, SHOULDER – ARMS	CO	The complete battalion acts as ordered.	

Table 9-3-1 (Sheet 6 of 6) Trooping the Colour

SECTION 4

CONSECRATION AND PRESENTATION OF NEW COLOURS

GENERAL

1. The battalion shall be formed in two ranks, in line at the open order, as for trooping the Colour (see Section 3). If the battalion has old Colours, they shall be positioned to the left front ready for trooping.
2. The non-commissioned officers of the Colour party for the new Colours shall be positioned 15 paces in the rear and centre of the battalion with the new colours cased at the slope. The officer(s) for the new Colours shall be positioned three paces in the centre front of the battalion.
3. The chaplains taking part in the ceremony will position themselves behind the dais, three paces to the right of the staff attending the personage presenting the new Colours. The senior chaplain shall be in line with the staff, the other chaplains behind him in line, in order of seniority from left to right.

NOTE

Colours are consecrated once. Commanders shall not re-consecrate their Colours. If the occasion warrants a ceremony then trooping the Colour should be considered.

PARADE SEQUENCE

4. The parade sequence is a variation of the trooping the Colour ceremony and is based, like that ceremony, on the review.
5. In summary, the differences commence after the inspection and are as follows:
 - a. If old Colours are on parade:
 - (1) the old Colours are trooped as described in Section 3, and
 - (2) the old Colours are marched off (paragraph 6).
 - b. the battalion forms hollow square and the new Colours are consecrated and presented as detailed below.
 - c. thereafter, the standard review format is followed, beginning with the march past. There are no further presentations, and the address by the reviewing dignitary is part of the ceremony of presenting the new Colours (see paragraph 31).

MARCHING OFF THE OLD COLOURS

6. After the old Colours have been trooped, and the escort has returned to its position in line, the commanding officer shall proceed as follows (Table 9-4-1):

FORMATION

7. The commanding officer shall order the parade to form hollow square.
8. On the commands FORM HOLLOW – SQUARE; ___ AND ___ COMPANIES, AT THE HALT, CHANGE DIRECTION LEFT AND RIGHT – FORM; and QUICK – MARCH, the flank companies shall form the hollow square.
9. The commanding officer then orders ORDER – ARMS; and STAND AT – EASE.
10. While the battalion is forming hollow square, the drums are piled under the command of the drum major.

No.	Command	By	Action	Remarks
1	MARCH OFF THE OLD COLOURS	CO	The Colour non-commissioned officers for the old Colours move into position from the supernumerary rank of the escort.	
2	COLOUR PARTY, BY THE LEFT, SLOW – MARCH	Sr Colour Officer	The Colour party steps off straight forward to a point 20 paces in front of the battalion.	The band shall play “Auld Lang Syne” until the Colours have left the parade ground.
3	COLOUR PARTY, CHANGE DIRECTION LEFT, LEFT – FORM	Sr Colour Officer	The Colour party acts as ordered.	
4	COLOUR PARTY, FOR – WARD	Sr Colour Officer	The Colour party shall step off and march from right to left across the front of the battalion.	As soon as the command FOR – WARD, has been given, the CO shall order:
5	BATTALION, TO YOUR COLOURS, PRESENT – ARMS	CO	If a royal or vice-regal personage is on parade, the Colours shall be dipped for 20 paces on passing the dais, then returned to the carry.	When the Colour party is opposite the left flank of the battalion, the Sr Colour Officer shall order:
6	COLOUR PARTY, CHANGE DIRECTION RIGHT, RIGHT – FORM; and FOR – WARD	Sr Colour Officer	The Colours shall be marched off the parade ground to a convenient place where they shall be cased.	As soon as the Colours have disappeared from sight, the band shall cease playing and the CO shall order:
7	BATTALION, SHOULDER – ARMS	CO	The battalion acts as ordered.	The CO then carries on with the procedures for the consecration of the new Colours.

Table 9-4- 1 Marching off the Old Colours

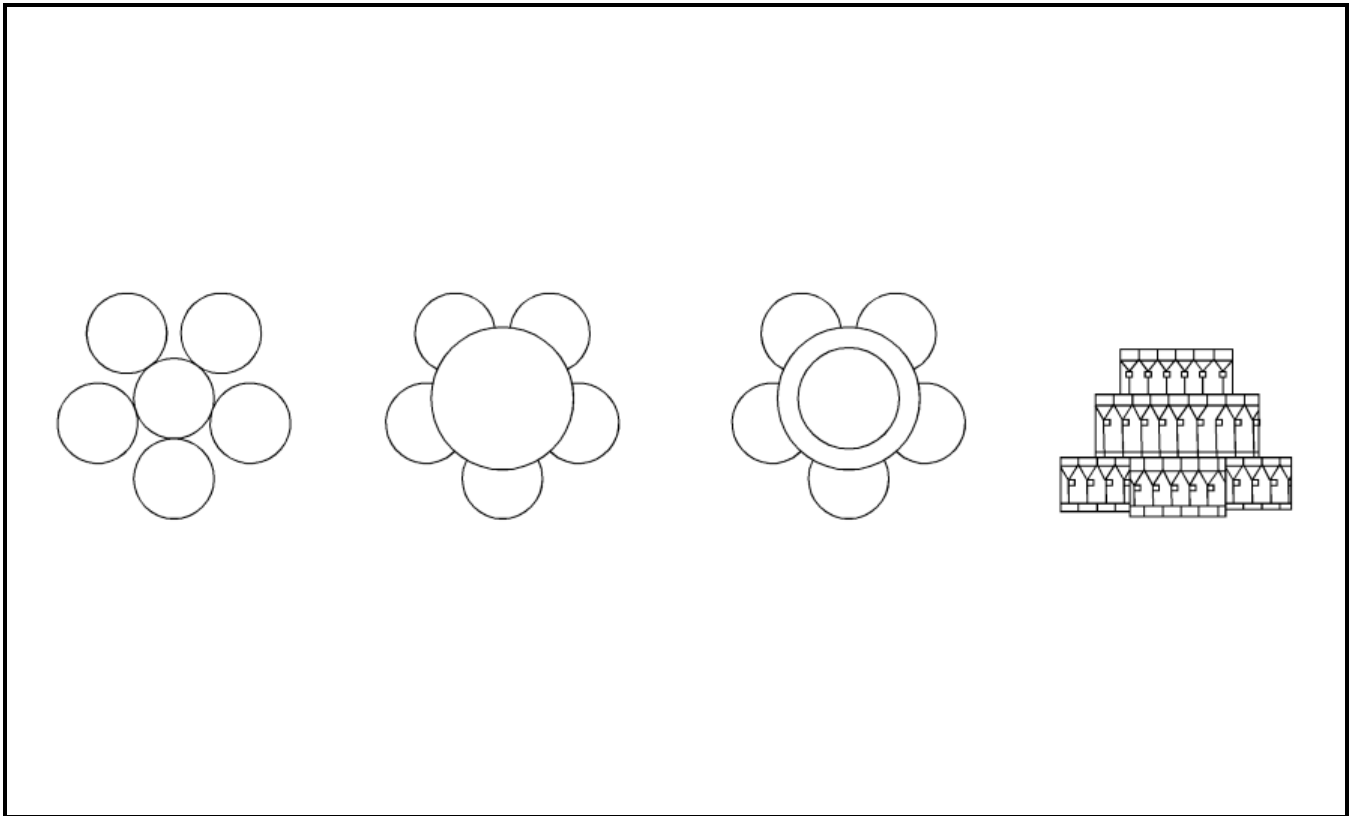

Figure 9-4-1 Piling Drums

PILING DRUMS

11. Prior to the drummers marching to pile drums, the drums shall be in the carry position.
12. On the command DRUMMERS, QUICK – MARCH by the drum major, the drum major, six side drummers, one bass drummer and one tenor drummer, march in single file and form a circle around the area where the drums are to be piled. The drum major then orders MARK – TIME; HALT; and INWARDS – TURN.
13. On the command PILE– DRUMS by the drum major, drums are unhooked and piled with the emblazonment the right way up, facing outwards. The emblazonment on the bass and tenor drums should face the person presenting the Colours. The first side drummer places his drum flat on the ground at the designated spot and steps back. Then, the other five side drummers step forward, place their drums flat on the ground around the first side drum and step back. The base drummer places his drum flat on the centre of the side drums, and finally the tenor drum is placed flat on the base drum head (see Figure 9-4-1). Two pegs may be put on either side of the tenor drum’s rim to steady the Colour pikes.
14. The drum major then orders RIGHT – TURN; and QUICK – MARCH. The drummers shall return in single file to the band.

OFFICERS FOR THE COLOURS

15. The junior officers who are to receive the new Colours (positioned in the centre of the line of officers) march forward on the command of the senior, who is on the right, and halt three paces in rear of and five paces from the right and left of the piled drums, facing the dais (see Figure 9-4-2).
16. Simultaneously, the two flank-company majors march from in front of their companies to positions five paces to the right and left of and facing the piled drums.

17. On the command RETURN – SWORDS by the senior of the majors the two majors and the officers for the Colours return swords. If the swords are slung, they are then hooked up.

COLOUR ESCORT

18. The remainder of the Colour party, consisting of the Colour escort, march forward from the rear of the parade ground, mark time and halt on the command of the Colour warrant officer. The escorts halt four paces in rear of and covering the junior officers. The Colour warrant officer halts three paces in rear of and between the escorts.

19. The escort carries the Colours cased at the slope. They also carry rifles, at the shoulder, on the left side.

COLOUR ORDERLIES

20. At the same time, the two Colour orderlies, who were positioned on either side of the dais, march forward together, carrying the kneeling cushions, and place them in front of the two junior officers. They, or other personnel, may also position any microphones. They then march to a position three paces in front of and one pace to the right and left of the Colour escorts in readiness to receive the Colour cases from the majors.

UNCASING THE COLOURS

21. The majors march to a position in front of the Colour escort and uncase the Colours, as detailed in Chapter 8, handing the cases to the Colour orderlies.

22. The Colour orderlies place the cases over their left forearms and return to their positions on either side of the dais.

PLACING THE COLOURS ON THE DRUMS

23. The majors take the Colours from the escort and place them on the drums, the Regimental Colour first and the Queen's Colour on top. The Colours are allowed to drape over the drums, facing the parade.

24. The escorts who brought the Colours on parade shall change arms, about turn, and, under command of the Colour warrant officer, march to their normal positions in the battalion's line, mark time, halt and order arms.

CONSECRATION

25. The commanding officer then addresses the Chaplain General and asks: "Reverend Sir, on behalf of (name of unit) we ask you to bid God's blessing on these Colours."

26. The Chaplain General replies: "We are ready to do so".

27. The CO then orders BATTALION REMOVE – HEADDRESS; STAND AT – EASE; and STAND – EASY.

28. The presenting dignitary moves to a position in front of the drums, facing the parade. Simultaneously, the Chaplain General moves to a position in rear of the drums, facing the reviewing dignitary, and the other chaplains take up their positions behind the Chaplain General (see Figure 9-4-2). The chaplains then proceed with the consecration in accordance with an authorized "Form of Prayer", copies of which may be obtained from formation, base or unit chaplains.

PRESENTATION OF COLOURS – PREPARATION

29. After the chaplains have completed the consecration service, the commanding officer shall order the battalion to replace headdress and call it to attention. The chaplains move to their left and take post on the left of, and in line with the junior major, facing the drums, where they remain during the presentation.

PRESENTATION OF COLOURS

30. The junior officers kneel with their right knee on the cushions. The senior major hands the Queen's Colour to the presenting dignitary, who presents the Colour to the junior officer on the right. The junior major then hands the Regimental Colour to the presenting dignitary who presents the Colour to the junior officer on the left. The Colour officers shall then rise together and the majors shall return to their positions by the drums, unhook their swords if necessary to conform with the remainder of the battalion, draw swords, salute and remain at the carry.
31. The commanding officer then orders BATTALION, STAND AT – EASE. The presenting dignitary then addresses the parade. The CO will normally make a short reply. Following the CO's reply, the dignitary and the chaplains return to the dais.
32. The commanding officer then orders BATTALION, ATTENTION; __ AND __ COMPANIES, ABOUT – TURN; AT THE HALT, CHANGE DIRECTION RIGHT AND LEFT – FORM and QUICK – MARCH. During this movement the two orderlies march forward, recover the kneeling cushions and microphones, about turn, and return to their positions. Simultaneously, the two majors rejoin their companies and the drums are recovered under the command of the drum major by reversing the method used for piling them. Once the flanking companies are back in line, the commanding officer then orders __ AND __ COMPANIES, ABOUT – TURN.
33. The commanding officer shall order BATTALION, SHOULDER – ARMS. On this command, the Colour officers shall reverse positions by spiral countermarching, halt facing the battalion and let fly the Colours.
34. The commanding officer then orders BATTALION, TO YOUR COLOURS, PRESENT – ARMS. On the last movement of the present, the Colour officers step off in slow time and, on reaching their positions on parade, they shall spiral countermarch and mark time. The band shall play the National Anthem in its entirety as the slow march; the Colour officers marking time until the music ceases. This movement places the Queen's Colour in its proper position on the right. The Colours are then caught and retained in the carry position.
35. As soon as the Colour officers have halted, the commanding officer orders SHOULDER – ARMS, and the battalion is ready to march past.

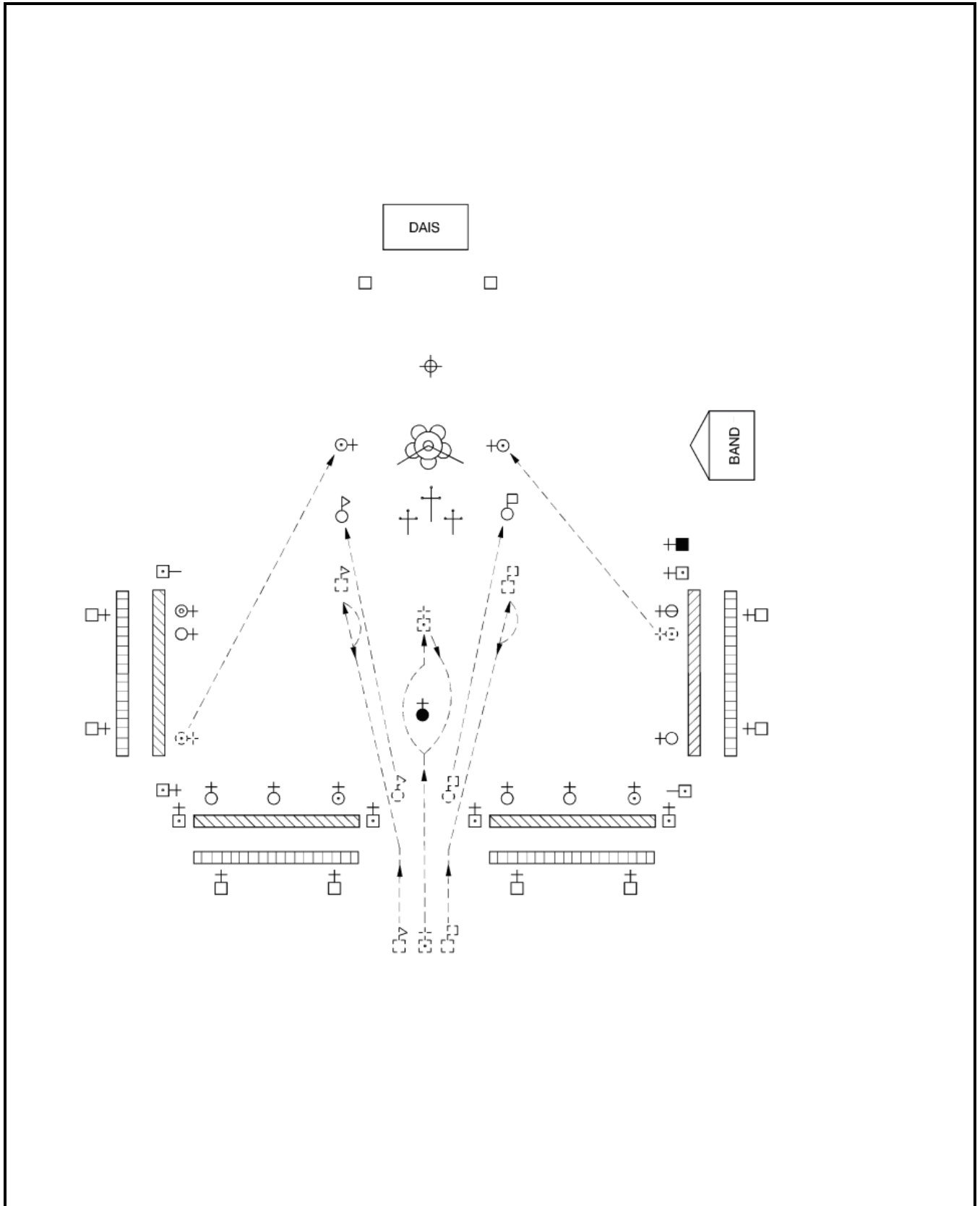

Figure 9-4-2 Consecration of Colours

SECTION 5

DEPOSITING OR LAYING UP OF COLOURS

GENERAL

1. Prior to the depositing or laying up of Colours, they shall be paraded or trooped and marched off the parade.

2. Colours may be layed up in either a sacred or public building as noted in A-AD-200-000/AG-000, Honours, Flags and The Heritage Structure of the Canadian Forces soon to become A-DH-200-000/AG-000, The Heritage Structure of the CAF. The detail below applies to a lay-up in a church, since that is the most common choice; it may be modified as necessary for other circumstances. In any case, a chaplain shall be present to dedicate the Colours as memorials to the unit they represent.

LAYING UP

3. On arrival at the church it is customary for the commanding officer or, acting on that officer's behalf, the adjutant to knock on the church's door and ask the chaplain for permission to enter the church with an armed party.

4. During the service in the church preceding the laying up ceremony, the Colour party shall remain at the back of the church.

5. The commanding officer or the senior unit officer present shall be seated on the inside of the right hand pew.

6. At the beginning of the last verse of the hymn preceding the ceremony, the Colour party, at the shoulder arms and wearing headdress, shall form up with the old Colours at the back of the church.

7. At the conclusion of the hymn, the regimental or other traditional slow march shall be played, and the Colour party, with the Colours at the carry, shall move forward in slow time, halting two paces from the chancel steps.

8. On the conclusion of the slow march, the chaplain, at the chancel steps says: "We are gathered together in this church to lay up these Colours of (name of unit). No more fitting place could be found wherein to deposit these emblems of duty and service than the House of God where praise and prayer are wont to be made"

9. The commanding officer then takes the Colours, one in each hand, moves to the top of the steps and halts.

10. The Colour party presents arms, officers salute with hands.

11. The commanding officer, preceded by the chaplain, advances in slow time to the altar rail and halts.

12. After the senior officer has handed over the Colours to the chaplain and the chaplain has received them on the altar, the senior officer turns about and resumes his seat. The Colour party shoulders arms and remains at the shoulder during the prayers and the benediction.

13. After the benediction, the National Anthem is played and the Colour party shall present and shoulder arms on the first and last notes of the Anthem.

14. The Colour party then moves to a side aisle before the choir and clergy leave the chancel.

SECTION 6

FEU DE JOIE

GENERAL

1. A Feu de Joie is a salute fired on occasions of rejoicing.
2. It is normally conducted as part of a battalion review, with the Feu de Joie being fired after any address and before the advance in review order.
3. On general celebration occasions, it may be fired as the sole purpose of the parade, in which case there is no need for an inspection, march past or advance in review order, and the commanding officer may choose to omit any or all of these.
4. If artillery is present, a gun salute may be fired in conjunction with the Feu de Joie.
 - a. The number of artillery rounds fired shall correspond to the rank, status or position of the person being saluted see Chapter 13 to A-AD-200-000/AG-000, Honours, Flags and The Heritage Structure of the Canadian Forces soon to become A-DH-200-000/AG-000, The Heritage Structure of the CAF, or the occasion being celebrated. The total number of rounds is divided into three sets, with a set fired before each series of the Feu de Joie. Odd numbers of rounds are fired in the last set or sets. If the Feu de Joie is fired in general celebration — rather than as a salute to an entitled individual or on an occasion, such as Canada Day, when a 21-gun salute is appropriate — the number of artillery rounds fired shall be nine.
 - b. The CO shall order LOAD, immediately the artillery commence firing, followed by PRESENT, when the last gun of the set has fired.

FEU DE JOIE

5. During the formation of the parade, the battalion shall be positioned in two ranks on the inspection line, at the open order, with bayonets fixed. Each member in the ranks shall have a rifle loaded with a magazine of three blank rounds.
6. Following the march past (and any address), the commanding officer shall take up his command position 15 paces in the front and centre of the battalion and proceed as noted in Table 9-6-1.

No.	Command	By	Action	Remarks
1	BATTALION WILL UNFIX BAYONETS – UNFIX	CO	As ordered.	
2	BAYO – NETS	CO	As ordered.	
3	BATTALION, ATTEN – TION	CO	As ordered.	
4	BATTALION WILL FIRE A FEU DE JOIE; BATTALION, TAKE – POST	CO	Officers shall step forward three paces. The rear rank and the supernumerary rank shall step back three paces. The Colours shall be brought to the carry position, and the Colour officers shall advance the extra paces required to bring them into line with the other officers, if not already in review order.	The Colours shall not be lowered to the attention position during the firing of a Feu de Joie.
5	BATTALION, WITH BLANK CARTRIDGES, STANDING – LOAD	CO	The markers and all non-commissioned members in the two ranks shall ready their weapons.	<p>The muzzles of the rifles will be inclined upwards, so as to clear the heads of the members in the front rank. The supernumerary rank shall remain at the order.</p> <p style="text-align: center;">NOTE</p> <p>Colour escorts do not load blank cartridges when Colours are on parade.</p>
6	BATTALION – PRESENT	CO	Officers should salute.	

Table 9-6- 1 (Sheet 1 of 3) Feu de Joie

No.	Command	By	Action	Remarks
7	COMMENCE	CO	The right-hand individual of the front rank shall commence the firing, which shall run down the front rank and up the rear rank as quickly as possible. When the right-hand member of the rear rank has fired, the band shall play the first half of "O Canada".	The command COMMENCE shall be used in lieu of FIRE. When the reviewing dignitary is a member of the Royal Family or a vice-regal appointment, the first six bars of "God Save the Queen" shall be played following the first volley.
8	BATTALION, RELOAD	CO	The ranks act as ordered. The officers return to attention or the carry.	
9	BATTALION – PRESENT	CO	See No. 6.	
10	COMMENCE	CO	See No. 7. The band shall play the second half of "O Canada"	When a member of the Royal Family is reviewing the parade, the second half of "God Save the Queen" shall be played. When the reviewing dignitary holds a vice-regal appointment, the first and last four bars of "O Canada" shall be played.
11	BATTALION RELOAD	CO	See No. 8.	
12	BATTALION – PRESENT	CO	See No. 6.	
13	COMMENCE	CO	See No. 7. The band shall play the whole of "O Canada".	The whole of "O Canada" shall also be played when a member of the Royal Family or a vice regal appointment is reviewing the parade.
14	BATTALION, MAKE – SAFE	CO	The ranks act as ordered.	Given when band has ceased to play.

Table 9-6-1 (Sheet 2 of 3) Feu de Joie

No.	Command	By	Action	Remarks
15	BATTALION, ORDER – ARMS	CO	As ordered.	
16	BATTALION, TAKE – POST	CO	The officers shall move to their original positions in line, the rear and supernumerary ranks stepping forward three paces. The Colour party shall resume its original position under the commands of the senior Colour officer.	
17	BATTALION WILL FIX BAYONETS – FIX	CO	As ordered.	
18	BAYO – NETS	CO	As ordered.	
19	BATTALION, ATTENTION	CO	As ordered.	
If the Feu de Joie has been fired as a salute to a personage who is present, the CO shall then order:				
20	BATTALION, REMOVE – HEADDRESS	CO	The headdress shall be removed and retained in the left hand.	
21	THREE CHEERS FOR __ HIP, HIP	CO	The battalion replies “hurrah” and all members raise their left arms to its full extent over their head.	The cheer is repeated three times.
22	BATTALION, REPLACE – HEADDRESS	CO	As ordered.	
23	BATTALION, SHOULDER – ARMS	CO	As ordered.	The parade shall then continue normally.

Table 9-6-1 (Sheet 3 of 3) Feu de Joie

ANNEX A

MOUNTED PARADES

ARMoured REGIMENTS – GENERAL

1. Armoured regiments may carry out ceremonial parades either mounted or dismounted.
2. The form of a mounted parade is dependent on the amount of space, surface conditions, etc., of the selected parade ground. Therefore, this annex is intended only as a guide.
3. The dais should be at least as high as the turret of the armoured fighting vehicle (AFV).
4. The commanding officer will detail in advance how the parade is to be controlled, whether by word of command, trumpet calls, visual signals, radio or a combination of these.
5. Personal weapons normally will not be carried on ceremonial parades where personnel are required to mount and dismount from the AFVs during the parade. However, they shall be carried by Standard/Guidon escorts when these are dismounted.
6. Depending on the surface and location of the parade ground, AFVs may be either pre-positioned on the parade prior to dismounted crews marching onto the parade ground or, if the surface conditions preclude this, the regiment may march on and form up on the inspection line with crews mounted throughout.
7. B Echelon vehicles may be present on a regimental parade, but normally are not present when trooping Colours.
8. The band should be in a stationary position behind or beside the dais throughout a mounted parade, since it is unlikely that dismounted movements will be possible after rehearsals with AFVs, unless the parade takes place on concrete hard standing. The music may be projected through a sound system.
9. Should the reviewing dignitary wish to address the regiment, troops shall dismount and form a hollow square in front of the AFVs.
10. The advance, if included in the parade, normally will take place prior to the drive past, in order to avoid more damage than necessary to the ground selected for the parade. This shall be carried out with the minimum interval between AFVs and at a slow speed. The advance should not be more than 30 to 50 m.
11. All AFV commanders shall salute in the normal manner. The AFV gun shall be traversed 45 degrees and dipped. The Standard/Guidon AFV shall not traverse nor dip its gun except to those entitled to a Royal Salute. The Standard/Guidon will be dipped when appropriate.
12. If the regiment has aircraft, they should be positioned, if possible, in the rear of the parade for the inspection and should fly past at the end of the parade.

ARMoured REGIMENTS – THE MOUNTED REVIEW

13. **Preliminaries.** The regiment's AFV's should be pre-positioned on the parade ground as follows:
 - a. The intervals should be:
 - (1) one AFV width between AFVs,
 - (2) no interval between troops, and
 - (3) three AFV widths between squadrons.

- b. The commanding officer's AFV should be 15 m in front of the regiment.
 - c. Depending on the size of the parade ground, the commanding officer shall decide in what multiples abreast the AFVs will drive past.
14. **Forming up on Parade.** The regiment shall form up on parade as follows:
- a. The band shall take up its designated position.
 - b. The officers and crews shall form up on each flank of the parade ground facing inwards.
 - c. The commanding officer's trumpeter shall sound the "Advance". On this call being sounded, the band shall play a double march and the crews shall double on parade and double mark time in front of their AFVs. When all crews are in position, the band shall cease playing. The bass drummer shall sound a drum beat at which time the crews shall halt, turn to the front and stand at ease.
15. **Marching on the Standard/Guidon.** The Standard/Guidon may be received by the regiment, either mounted or dismounted. The former is preferable since the crews will not normally be carrying personal weapons.
- a. **Mounted**
 - (1) The commanding officer's trumpeter shall sound "Mount".
 - (2) Crews shall mount and remain at attention.
 - (3) The trumpeter sounds "G" as an order to the Standard/Guidon AFV to drive on the parade ground.
 - (4) As the Standard/Guidon AFV comes onto the parade ground, the trumpeter shall sound the call "Carry Swords" as the order to salute, and the band shall play the appropriate salute.
 - (5) The Standard/Guidon AFV shall drive onto the parade ground at an appropriate speed and take up its position centrally behind the commanding officer's AFV. The crew shall not dismount on parade.
 - (6) The trumpeter shall then sound the call "Slope Swords" as the order to return to attention.
 - b. **Dismounted.** The procedures are the same, but without the "Mount". If crews are carrying personal weapons, they shall present arms on the call "CARRY SWORDS" and shoulder arms on the call "Slope Swords"; otherwise only officers salute.

NOTE

Normal verbal commands may be used if a trumpeter is not available.

16. **Reception of the Reviewing Officer.** If the reviewing officer is received mounted, the procedure shall be the same as for receiving the Standard/Guidon, except that the crews are already mounted. On completion of the appropriate salute, the "Dismount" shall be ordered or sounded and the crews shall fall in at the front of their AFV. If the reviewing officer is received dismounted, there will be no change in the procedure.

17. **Inspection**

- a. The inspection shall take place either mounted in a military pattern vehicle or AFV, or dismounted, depending on how far the inspection line is set back from the saluting base and the condition of the ground.
- b. Following the inspection, the commanding officer shall accompany the reviewing officer back to the dais and then will resume his position in his AFV. If a vehicle is used to convey the reviewing officer, it shall then drive off the parade ground.

18. **Advance.** The normal procedure for the advance is as follows:

- a. The order shall be given or sounded to mount. Crews, having mounted, shall carry out preliminary starting drills and, when ready, AFV commanders shall raise their right arms. When all are ready, the order shall be given to "Start Up". AFV commanders shall drop their arm when their AFVs have started. When all are started the CO shall order the advance.
- b. Alternatively, on the command to start up, the driver only shall mount; the remainder shall about turn. When the engine of an AFV is started, the crew shall about turn to face the front. The commanding officer shall give the signal to mount when all have started and order the advance.
- c. The regiment then shall advance 30 to 50 m and the band shall play. On halting, the commanding officer shall order the appropriate Salute.
- d. The advance shall only be carried out if circumstances permit.
- e. The regiment then shall drive off to take up its position for the drive past.

19. **Drive Past**

- a. The drive past shall be by squadrons in column of troops in the following order:
 - (1) regimental headquarters,
 - (2) the Standard/Guidon party,
 - (3) squadrons in alphabetical order,
 - (4) A1 Echelon, and
 - (5) A2 Echelon.
- b. The speed of the drive past will depend on the surface, dust conditions, etc. The ideal speed is 15 to 20 km/h.
- c. Crew commanders shall give the order for their gunners to traverse right and dip to maximum depression since the gunners will be unable to see the marker flags. On reaching Point D (Figure 9-2-1), the guns shall commence elevating to 10 degree elevation and traverse front.
- d. After driving past, the regiment shall drive off the parade ground, followed by the band.

ARMoured REGIMENTS – TROOPING THE STANDARD/GUIDON

20. **General.** The procedure shall be the same as for a mounted review. The Standard/Guidon shall be trooped after the inspection and before any advance and the drive past.

21. **Trooping**

- a. The trumpeter shall sound the Regimental Call and the band shall play a fanfare.
- b. The Standard/Guidon party shall drive off to the left of the regiment at 10 km/h.
- c. The trumpeter shall sound the call "Carry Swords" as an order to salute or present arms when the Standard/Guidon party reaches the left flank.

- d. The Standard/Guidon party shall pass in front of the regimental line with its escort AFVs following and with the Standard/Guidon let fly. The band shall play.
- e. When the Standard/Guidon party reaches the right flank:
 - (1) the trumpeter shall sound the call "Slope Swords" as order to shoulder arms or return to attention; and
 - (2) the Standard/Guidon party shall wheel back into its position on parade.

ARTILLERY – GENERAL

22. Artillery units may parade either mounted or dismounted, however the normal procedure is to carry out an ordinary dismounted parade followed by a mounted drive past.

23. Mounted drive pasts are generally performed when a regiment or battery wishes to parade its Colours, the guns, on special occasions. Because the Colours are the focus of the drive past, only F Echelon AFVs need take part.

24. Guns shall not be decorated, used as mere decoration or placed unprotected around the edge of a parade square. If artillery guns are positioned on the parade ground during parades, other than as AFVs or towed equipment for mounted drive pasts, they shall only be used in lieu of flags to mark Flag Points C and D (Figure 9-2-1), with a detachment sentry at each gun. Immediately after the march or drive past, these guns should be removed from the parade ground.

25. Depending on the size, surface conditions, etc., of the parade ground, AFVs and guns may be either pre-positioned on the parade ground in rear of the dismounted parade (Figure 9A-1) or in some other location adjacent to the parade ground prior to the unit falling in for the dismounted parade.

26. The dismounted parade is conducted as a normal review (except that artillery units do not fix bayonets when parading by themselves) up to the end of the Royal (General) Salute following the advance in review order. In addition:

- a. the Standard of The Royal Regiment of Canadian Artillery shall be flown from the main flagpole situated in rear of the dais;
- b. regimental pennants shall be flown from antennas on the commanding officer's, the deputy commanding officer's and battery commanders' AFVs; and
- c. the reviewing dignitary and spectators must be made aware that a mounted drive past will take place.

27. On completion of the Royal (General) Salute at the end of the dismounted portion of the parade, the commanding officer's trumpeter shall sound "Mount" (a "G" may also be sounded after the call to provide an executive command). All ranks shall observe a standard pause, turn right, observe a standard pause, port arms, observe another standard pause and, under control of their sub-unit commanders, double to their guns and AFVs, mounting on arrival.

28. Once mounted, AFV commanders shall stand at attention, grasping the top of the windshield with their left hand, or be seated as applicable. All personnel seated in the rear of AFVs shall sit at attention, grasping their personal weapons between their knees.

29. Once the regiment has cleared the inspection line, the band shall position itself on that line facing the dais. The band shall play appropriate music while the regiment is mounting and starting its AFVs. The band conductor will remain alert for the commencement of the drive past.

30. When all personnel are mounted, the commanding officer shall order "Start Up" by raising his right arm vertically above his shoulder and moving the arm in a circular motion or by having his trumpeter sound the order.

When all their AFVs are running, battery commanders will notify the commanding officer by raising their right arm vertically above the shoulder as for gun drill. The commanding officer will acknowledge this signal in the same manner.

31. On the command or trumpet call, DRIVE PAST BY BATTERIES IN COLUMN, RIGHT WHEEL, FOR – WARD, each battery shall wheel to the right and drive off, maintaining the interval depicted in Figure 9A-2. The column shall not exceed a speed of 8 to 10 km/h.

32. During the drive past, the band shall play the regimental trot past, “Keel Row”, for all artillery units except those of the Royal Canadian Horse Artillery, and the regimental gallop past, “Bonnie Dundee”, for Royal Canadian Horse Artillery units.

33. On the command EYES – RIGHT, all AFV commanders shall salute, commencing at Point C (Figure 9-2-1) and ending at Point D. All other personnel shall look directly to their front.

34. On the completion of the eyes front at Flag D, the commanding officer shall fall out of the column and join the reviewing officer at the dais. The deputy commanding officer shall lead the regiment from the parade square to the dispersal area, all personnel remaining mounted.

ARTILLERY – THE MOUNTED REVIEW WITH SELF-PROPELLED GUNS

35. Mounted parades with self-propelled guns are conducted in a similar manner to those for an armoured regiment (see above). However, the guns shall not be traversed or dipped while driving past, and a trooping ceremony is not carried out.

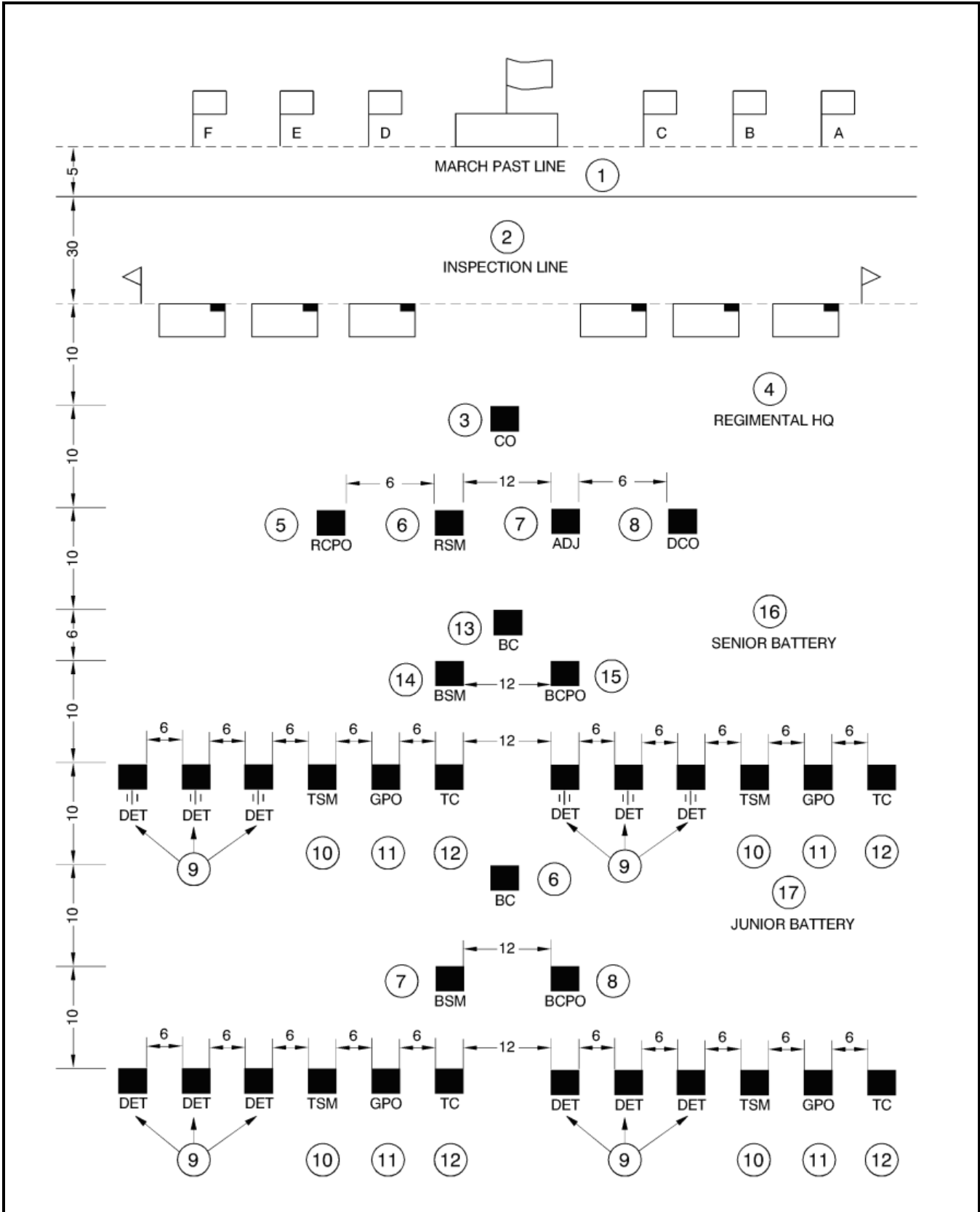

Figure 9A-1 Artillery – Position of Vehicles

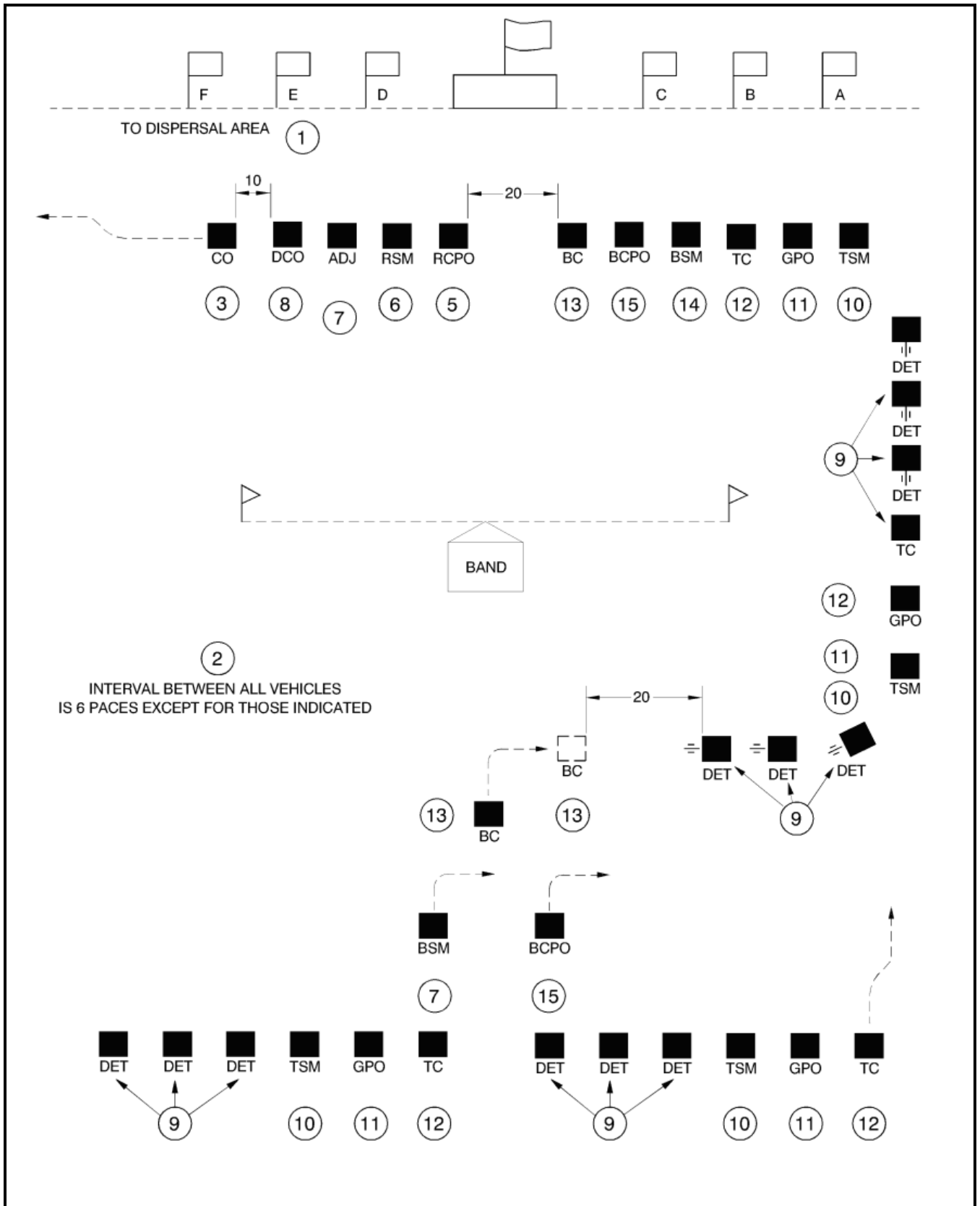

Figure 9A-2 Artillery – Drive Past

ANNEX B

MODIFICATIONS TO PARADE PROCEDURES – EXAMPLE: TROOPING THE COLOUR

INTRODUCTION

1. Parade commanders can modify procedures to meet particular circumstances. An example is the ceremony known as “Trooping the Colour and Guard Mounting from Horse Guards Parade” conducted annually by British foot guards in London, England. The parade is composed of four “guards” found from foot guard battalions in London District. Some of the guards continue after the parade to mount guard at the Royal palaces. Because of these unique circumstances, among other differences:

- a. the parade is not composed of a single organized battalion, but rather a group of guards;
- b. the size of each guard is determined by the space on Horse Guards Parade (a specific public parade ground in London) and the duties to be performed by The Queen’s Guard;
- c. the rank, number and positions on parade of officers with each guard are tailored to the duty to be performed and are based on 19th Century company organizations, as are the rank, number and positions on parade of supervisory warrant officers and senior non commissioned officers with each guard;
- d. only one Colour (that which is to accompany The Queen’s Guard to its duties) is ever carried; and
- e. left guides (vice right markers) are marched (not called) forward onto the parade ground, the parade marches on as a battalion (vice companies), left (vice right) dresses, etc., to fit the peculiarities of that specific location and occasion.

2. This is not the only trooping ceremony carried out by British foot guards prior to mounting guard in London or on other occasions elsewhere, but it was used almost verbatim in army ceremonial publications as an example of trooping the Colour, and copied unchanged into Canadian manuals until 1976. It is retained as an example of how parade commanders can modify procedures to fit specific circumstances. Commanders may continue to follow this unique procedure at their discretion. They should be aware that additional training will be required because the non-standard positions on parade and parade routines involved.

3. Care must be taken not to slavishly follow the detail in this annex to the point of either:

- a. needlessly removing officers and non-commissioned members from a parade which troops their Colour, on the grounds that the detail for this specific version of the ceremony does not provide them with a position on parade; or
- b. failing to carry out a trooping ceremony, on the grounds that the unit’s establishment is too small to meet the guard numbers laid down in this particular example.

SEQUENCE

4. The sequence of events in trooping the Colour is as follows:

- a. the battalion is reorganized into four “guards” and parade appointments modified as noted below;
- b. the guards are formed up on the parade ground using a special display routine;
- c. the Colour is trooped, and the guards are then marched past in slow and quick time; and
- d. the parade’s conclusion is changed if the reviewing officer remains until the troops march off to other duties.

REORGANIZATION

5. The battalion is organized into four sub-units. Other than the Escort for/to the Colour, the companies are referred to as Nos. 2, 3 and 4 Guards (reflecting the convention for numbering sub-units in foot guard battalions, and the subsequent duties of the guard on the right of the line). Whenever possible, the strength of the escort and each guard shall be:

- a. One major or captain (three paces in front of the second file from the right).
- b. One captain or lieutenant (three paces in front of the second file from the left).
- c. One lieutenant or second-lieutenant (three paces in front of the centre of the guard).
- d. One master warrant officer (Right Marker, on the right of the front rank).
- e. One warrant officer (Left Marker, on the left of the front rank).
- f. One sergeant (Right Marker, three paces in rear of the second file from the right except where otherwise stated).
- g. One sergeant (Left Marker, three paces in rear of the second file from the left except where otherwise stated).
- h. One additional sergeant (Supernumerary, three paces in rear of the third file from the left of the Escort for the Colour).
- i. Seventy-two rank and file, or a number not less than 48, that is divisible by both three and four (to form two or three ranks).

6. If the deputy commanding officer joins the parade, his position will be on the right (vice left) of the line of officers, the adjutant in a similar position, but on the left (vice right) of the line. During the march past the deputy commanding officer will march behind the commanding officer, but lead when the commanding officer moves to the right of the dais. The adjutant's position will be in rear of the rear guard during the march past.

7. The Colour Officer shall be the junior lieutenant of the Escort for the Colour. The initial Colour party, positioned in front of the left flank of the battalion, shall consist of:

- a. Colour Warrant Officer – one master warrant officer or warrant officer.
- b. Colour Sergeant – one sergeant.
- c. Colour Sentries – two corporals or privates (later to form the right single file of the Escort to the Colour).

FORMING-UP ON PARADE

8. The normal forming-up sequence in Table 7-4-1 is adjusted as follows:

9. **Falling in as a Unit.** Prior to advancing onto the parade ground, the guard master warrant officers shall fall in the escort and guards at the assembly area detailed in the Parade Order, call the roll, size and inspect their guards. The escort and guards shall be formed in line under the command of the master warrant officer of the Escort for the Colour, while the master warrant officer and sentries attending the Colour and the orderly uncasing the Colour shall position themselves to the left of No. 4 Guard, the left markers will form in line to the right front of the Escort for the Colour and the band and drums shall form on the right flank of the Escort for the Colour.

10. **Markers.** On the bugle call "Markers", the chief warrant officer marches the left markers onto the parade square, halting when the marker for the escort reaches the proper position (left marker rather than right marker positions being determined in advance). The chief warrant officer then positions the markers following the normal procedure for markers in Table 7-4-1.

11. **The Advance.** When the "Advance" is sounded to order the assembled unit onto the parade ground, the escort and guards, under the command of the master warrant officer of the escort, and led by the band, is marched in column of threes onto the parade ground, approaching from the left, and at the frontage of each guard behind the posted line of guards on the inspection line (see Figure 9B-1). A sentry or mark on the right of the parade ground is normally used to align the marching troops.

- a. The initial Colour party (the Colour officer being with the others), with cased Colours, shall follow No. 4 Guard, wheeling independently to position itself on the left flank of the parade ground. The master warrant officer shall carry the cased Colour at the slope, and his or her rifle at the shoulder on the left side. On arriving into position, the Colour is uncased, and the Colour escorts, acting as sentries, commence patrolling a beat of ten paces (see Section 3, paragraphs 16 to 18).
- b. The band ceases playing as the last guard approaches its position in line, and the chief warrant officer orders AT THE HALT, FACING LEFT, FORM COLUMN OF GUARDS. Each master warrant officer then orders AT THE HALT, ON THE LEFT, FORM – GUARD. This will bring the marching troops into line, facing the right side of the parade ground, with their left files wheeling to meet the posted left markers.
- c. As the guards halt in place, the officers commence promenading on the parade ground's right flank, forward of the inspection line.
- d. The band wheels to position itself for the trooping as noted in Section 3, paragraph 8.
- e. The chief warrant officer then orders the guards to form two ranks and dress by the left. The master warrant officers shall take up positions, as the left markers turn left, by marching off five paces, halting, turning about and dressing their escort or guard, ordering ranks STEADY in succession (i.e., ESCORT, TWO, THREE, NO. FOUR GUARD, FRONT RANK – STEADY, etc.). Their movements are completed together.

The chief warrant officer orders TELL OFF BY GUARDS (the answers, in sequence, are ESCORT FOR THE COLOUR, TWO GUARD, THREE GUARD, NO. FOUR GUARD – no confirmation is given by the chief warrant officer since the parade's composition was pre-determined), and then ORDER – ARMS, and STAND AT – EASE.

12. **Forming Under the Adjutant.** Following the parade being stood at ease by the chief warrant officer, the adjutant shall march from his position behind the dais onto the parade ground, and advance towards the chief warrant officer. The following commands (Table 9B-1) are then given:

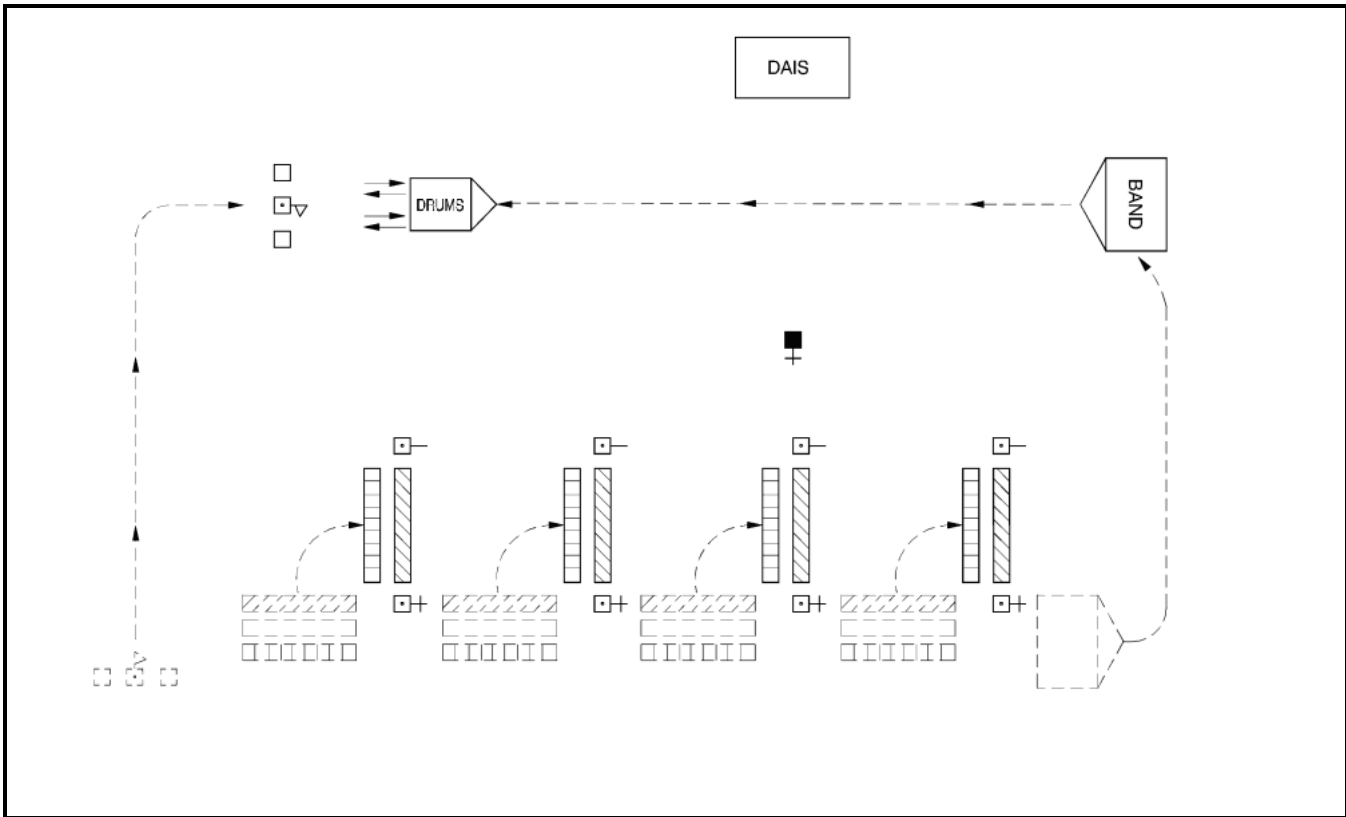

Figure 9B-1 March on for Trooping the Colour

13. **Fall in of the Officers.** Upon the parade completing, the commanding officer shall march from his position in the rear of the dais onto the parade ground, advance towards the adjutant and halt two paces in front of him. The adjutant shall salute and, after the commanding officer has returned the salute, he shall report "Guards formed as ordered, __officers and __ non-commissioned members on parade, Sir". Upon being ordered to fall in, the adjutant shall draw his sword, salute, and upon the salute being returned, he shall turn left and march off to a position, three paces in front of the last single file on the left flank. Having taken over the parade, the commanding officer shall draw his sword and proceed as follows (Table 9B-2):

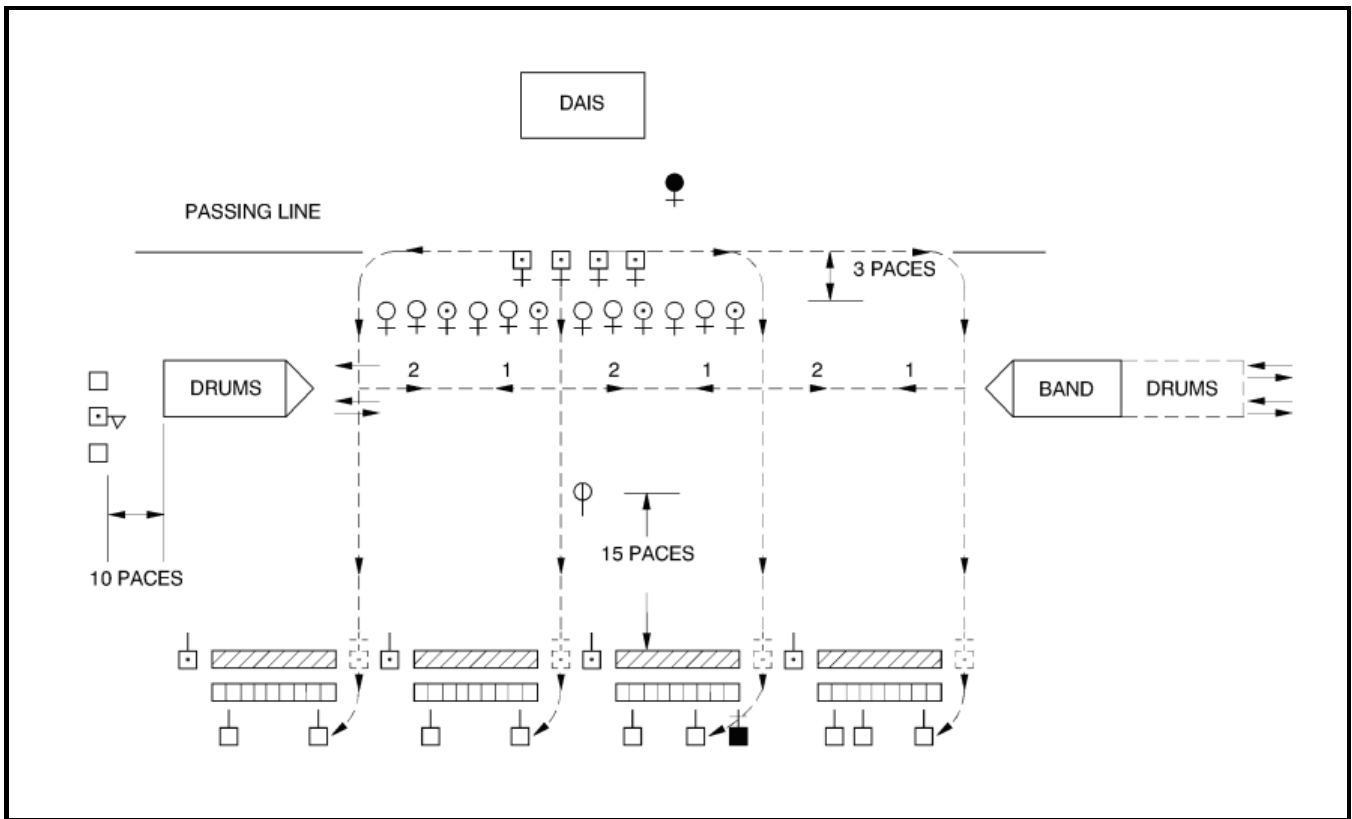

Figure 9B- 2 Officers and WO's Prior to Taking Post in Front of their Guards

No.	Command	By	Action	Remarks
1	GUARDS, ATTENTION	CWO	Escort and guards come to attention.	
2	GUARDS, SHOULDER – ARMS	CWO	Escort and guards shoulder arms.	As the adjt halts two paces in front of the CWO, the CWO shall salute, the adjt will return the salute and the CWO reports, “Guards formed as ordered, ___ officers and ___ NCMs on parade, Sir”. The adjt shall order the CWO to fall in and, after they exchange salutes, the CWO shall turn to his left and march to a position one arm’s length in front of the inspection line and in line with the rear rank of No. 4 Guard.
<p>When the adjt has taken over the parade, the officers shall cease to promenade and form a line along the right flank, ahead of the band. The officers of No. 4 Guard will be on the right flank of their line, with the remainder in sequence so that the officers of the escort are on the left flank.</p>				
3	GUARDS, AT THE HALT, ON MARKERS, LEFT – FORM	Adjt	The front of the escort and each guard shall execute a left incline and the left markers turn left.	On the command “FORM”, the left marker of the escort and each guard shall turn left, double out around the flank of their respective sub-unit to a point at arm’s length in front of where the second file from the right flank of their sub-unit shall stand when the line is formed, halt and taking the time from the marker of the escort, turn about and recover arms. The CWO shall cover the markers.

Table 9B-1 (Sheet 1 of 4) Forming under the Adjutant

No.	Command	By	Action	Remarks
4	MARKERS – STEADY	CWO	The markers shall shoulder arms from the recover.	
5	GUARDS, QUICK – MARCH	Adjt	The escort and each guard completes the movement, forming in line on the inspection line.	The CWO moves to a position one pace to the left of the line and aligned with the front rank.
6	GUARDS, OPEN ORDER – MARCH	Adjt	The rear rank of each guard and the escort take three half paces back.	
7	GUARDS, LEFT – DRESS	Adjt	Each guard and the escort shall dress. The dressing may be done either by full arm, or shoulder dressing. On the command DRESS, the left markers at arm's length in front of the alignment shall turn their heads to the left and at the same time extend their left arms sharply toward the line, parallel to the ground, fists clenched, on which the line will dress.	The CWO shall turn left, march out four paces, turn about and proceed to dress the front and rear ranks, ordering each rank STEADY once it is dressed. Upon completing the dressing of the rear rank, the CWO shall turn left, return to a position six paces to the left of the front rank, halt and turn right.
8	GUARDS, EYES – FRONT	CWO	The escort and guards shall act as ordered. On the command FRONT, the left markers shall turn their heads to the front, at the same time cutting their left arm to the side, turn left and double through the ranks to their places in line and halt. The necessary files in the escort and each guard will "make way" by taking one pace to the rear and one pace to the side, to allow the markers to double through. The CWO shall take up his position in the supernumerary rank in rear of the right marker of No. 2 Guard.	

Table 9B-1 (Sheet 2 of 4) Forming Under the Adjutant

No.	Command	By	Action	Remarks
9	WARRANT AND NON-COMMISSIONED OFFICERS COMMANDING GUARDS, TO THE – FRONT	Adjnt	On the command FRONT, the WOs commanding guards shall step forward two half paces and recover arms.	The right hand person of the rank shall move forward and fill the interval left vacant by his commander.
10	QUICK – MARCH	Adjnt	The WOs shall step off in quick time at the recover, the drums beating a quick march. On the WOs reaching the march past line, No. 3 Guard WO shall halt and the remainder shall turn inwards and close on the centre WO and halt as shown in Figure 9B-2.	The drums will continue to beat until the last WO has halted. Taking their time from the No. 3 Guard WO, all the WOs will turn and face the line, the No. 3 Guard WO turning about, the remainder turning left and right and all shall shoulder arms from the recover.
11	GUARDS, ORDER – ARMS	Adjnt	The escort and guards order arms.	The WOs act with the line and order arms.
12	GUARDS, STAND AT – EASE	Adjnt	The escort and guards stand at ease.	The WOs act with the line and stand at ease. On the command EASE, the officers shall come to attention and draw swords.
13	OFFICERS, RIGHT – TURN	OC the Escort	The officers right turn.	
14	DRUMS, QUICK – MARCH	Drum Major of Drums	The drums shall beat the assembly, marching across the front of the line. They shall march through the intervals of the band, counter march, and halt in rear of it.	Moving on the Drum Major's command, the officers shall step off, swords at the carry. The leading officer shall wheel to the left, three paces short of the march past line, the reminder following. They shall pass inside the drums and three paces in front of the WOs.

Table 9B-1 (Sheet 3 of 4) Forming Under the Adjutant

No.	Command	By	Action	Remarks
15	OFFICERS – HALT	OC the Escort	The officers shall halt three paces in front of the WOs and three paces from each other as shown at Figure 9B-2.	
16	OFFICERS, INWARDS – TURN	OC the Escort	The officers shall turn to face the line.	The officers shall stand at ease, in succession by guard from right.
17	GUARDS ATTEN – TION	Adjt	The escort and guards shall come to attention.	The officers and WOs shall act with the line.
18	GUARDS WILL FIX BAYONETS – FIX	Adjt	The escorts and guards act as ordered.	The WOs will act with the line.
19	BAYO – NETS	Adjt	The escort and guards act as ordered.	The WOs will act with the line.
20	GUARDS, ATTEN – TION	Adjt	The escort and guards act as ordered.	The WOs will act with the line.
21	GUARDS, SHOULDER – ARMS	Adjt	The escort and guards shall shoulder arms.	The WOs will act with the line.

Table 9B-1 (Sheet 4 of 4) Forming Under the Adjutant

No.	Command	By	Action	Remarks
1	OFFICERS, WARRANT AND NON-COMMISSIONED OFFICERS, OUTWARDS – TURN	CO	The officers, WOs and NCOs of the escort and No. 2 Guard turn left, the remainder turn right.	After completing the turn, those falling in recover swords or arms.
2	TAKE POST IN FRONT OF YOUR GUARDS, QUICK – MARCH	CO	The WO of No. 3 Guard shall stand fast, whilst the remaining officers, WOs and NCOs shall step off. The drums shall beat the step until all have halted opposite their positions in line.	When the drums cease playing, they shall beat a tap and two five-strokes followed by a flam, all will turn facing the line, officers returning swords to the carry, the WOs and NCOs returning rifles to the shoulder arms positions.
3	TO YOUR GUARDS, SLOW – MARCH	CO	The officers, WOs and NCOs shall step off in slow time, the officers recover swords on the first pace, the WOs and NCOs recover arms on the first and third paces. Dressing by the centre. The CO steps off with sword at the carry and halts 15 paces from centre of the line of guards.	The band will play a slow march, ceasing to play as the WOs and NCOs arrive at their places in line. When the officers arrive at three paces from line, they shall mark time. The WOs and NCOs shall mark time when on the right of their guards, the right hand rear-rank persons having turned about, marched in slow time and returned to their position six paces from the line.
4	OFFICERS, WARRANT AND NON-COMMISSIONED OFFICERS – HALT	CO	The officers, WOs and NCOs and rear rank personnel halt.	The command is given immediately after all have taken up marking time.
5	OFFICERS, WARRANT AND NON-COMMISSIONED OFFICERS, ABOUT – TURN	CO	The officers, WOs, NCOs and rear rank personnel shall turn about. The WOs and NCOs will shoulder arms after turning.	The officers remaining at the recover, shall pick up their dressing by the right.

Table 9B-2 (Sheet 1 of 2) Fall in the Officers

No.	Command	By	Action	Remarks
6	OFFICERS – STEADY	Adjt	Officers shall turn head and eyes to the front and return swords to the carry position.	
7	GUARDS, ORDER – ARMS	CO	The escort and guards order arms.	
8	GUARDS, STAND AT – EASE	CO	The escort and guards stand at ease.	The CO turns to face the saluting base. The guards await the arrival of the reviewing dignitary.

Table 9B-2 (Sheet 2 of 2) Fall in the Officers

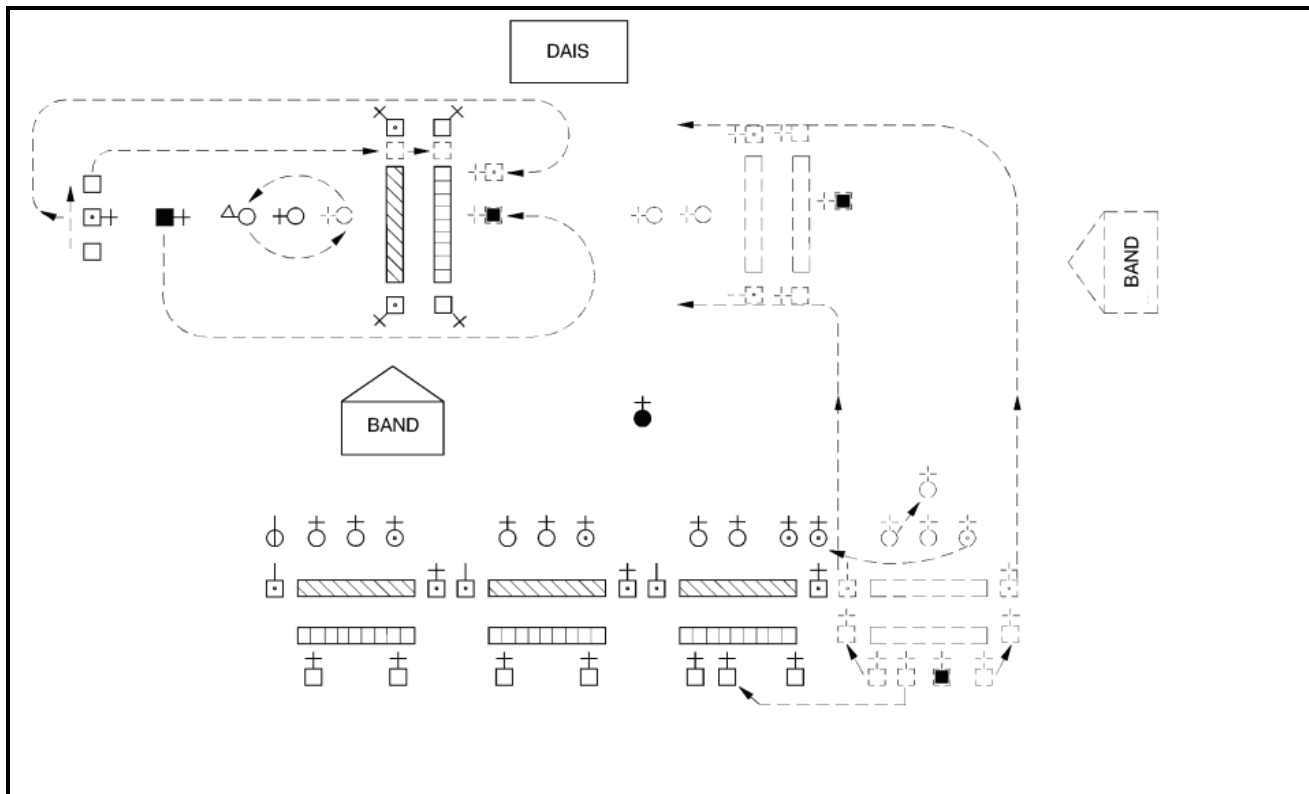

Figure 9B-3 The Escort Receiving the Colour

INSPECTION, TROOPING THE COLOUR, MARCH PAST

14. The unit will then receive the reviewing officer, be inspected, troop the Colour, and march past as normal (see sections 2 and 3).

15. When the commanding officer orders GUARDS, CLOSE ORDER – MARCH, in preparation for the march past, the command CLOSE is given as an execution word of command. The officers shall turn left on hearing it, and step off on MARCH, as the rear ranks move forward, to their positions for the close order.

- a. The guard commanders shall move to positions six paces front and centre of their guards.
- b. The lieutenants move around the left flank of their guards (the left markers shall make way by taking a pace to the rear and a pace to their right), to position themselves as follows: the lieutenants three paces rear and centre of the right half of their guard; and the second lieutenants three paces rear and centre of the left half of the guard.
- c. The rear rank markers of the escort move back to their position in the supernumerary rank.
- d. The Colour officer shall take post three paces in rear of the fourth file from the left of the escort, the centre files of the escort making way to allow him to pass through by taking a pace to the rear and to the side.
- e. The chief warrant officer shall take position three paces in rear of the Colour officer.
- f. The sergeant who formerly held the Colour, shall take position to the right of the Colour, and the supernumerary sergeant shall return from No. 2 Guard to the escort and take position to the left of the Colour.

16. During the left form at Point 1 (see Figure 9-2-1), the officers of the escort and each guard shall reposition themselves in front of their escort and guard as detailed in paragraph 5, by moving around the left flanks of their respective guards. The Colour party shall move across the rear of the escort so that the Colour officer is positioned three paces in rear of the fourth file from the right of the escort.

17. The Colour party shall change flanks during the second and third left forms at points 1 and 2 (see Figure 9-2-1) in both slow and quick time.

18. As the last guard passes the saluting base, the band and drums shall step off in quick time, wheel left in front of the dais with the Drum Major saluting, and follow the rear guard. The band and drums shall proceed around the right flank of the guards and halt in rear and centre of the line. As soon as No. 4 Guard has completed the last left form at Point G (see Figure 9-2-1), the band and drums shall cease playing.

THE ADVANCE, PRESENTATION AND ADDRESS

19. After the escort and guards have been halted, the commanding officer may proceed with procedures similar to those for a battalion review.

20. If the parade is to end normally, the sequence shall be presentations (if any), the address by the reviewing officer, advance in review order, and the departure of the reviewing officer (see Section 2).

21. If the reviewing officer is to stay to watch the troops march off to their other duties, the sequence shall be: advance in review order and salute, presentations (if any), the address, a retire to the inspection line (on the commands GUARDS WILL RETIRE, ABOUT – TURN; BY THE CENTRE QUICK – MARCH; GUARDS – HALT; and GUARDS, ADVANCE, ABOUT – TURN). The unit will then march off as noted below.

THE MARCH OFF

22. As soon as the about turn has been completed, if the dignitary is remaining to observe the march off, the commanding officer shall proceed as follows (Table 9B-3):

No.	Command	By	Action	Remarks
1	GUARDS WILL REFORM THREE RANKS, REFORM, THREE – RANKS	CO	The escort and guard shall act as ordered.	
2	GUARDS, RIGHT – DRESS	CO	The escort and guards shall act as ordered.	The right marker of the escort shall dress the rank. On his command REAR RANK – STEADY, the CO shall order:
3	GUARDS, EYES – FRONT	CO	The escort and guards shall act as ordered.	
4	GUARDS, MOVE TO THE RIGHT IN COLUMN OF ROUTE, RIGHT – TURN	CO	The escort and guards shall act as ordered. The officers and supernumeraries, after turning right, shall step off and take up their positions as for in column of route.	<p>The Colour party, between Nos. 2 and 3 Guards, shall form to the right. The CWO shall position himself three paces in rear of the Colour officer. The band and drums shall move to the head of the column.</p> <p style="text-align: center;">NOTE</p> <p>The guards may also be marched off in column of guards.</p>
5	GUARDS, BY THE LEFT, QUICK – MARCH	CO	The escort and guards shall step off (the band leading and playing quick marches) and wheel left at Point H and again on reaching the march past line. The CO shall order, “BY THE RIGHT”, after the second wheel to the left.	When arriving at a point between Points B and C, the CO shall order:
6	IN SUCCESSION BY GUARDS, EYES – RIGHT	CO		

Table 9B-3 (Sheet 1 of 2) The March off

No.	Command	By	Action	Remarks
7	ESCORT TO THE COLOUR (No. ___ GUARD) EYES – RIGHT	Guard Comds	The escort and guards in succession, turn their head and eyes to the right, the right markers only looking to the front.	The Escort Comd gives this command as the CO reaches Point C, others as their guard reaches Point C.
8	IN SUCCESSION OF GUARDS, EYES – FRONT	CO	Given at Point D.	
9	ESCORT TO THE COLOUR (No. ___ GUARD), EYES – FRONT	Guard Comds	Given at Point D.	CO ceases salute on Escort Comd's order. Escort Comd (or D Comd) may take over command, the CO joining the reviewing dignitary.
10			The escort and guards are marched off the parade ground to the dismissal area, halted, and turned into line. The Colour shall then be marched off, the officers fallen out by the DComd or Escort Comd, and the CWO shall take over control and have the Guard MWOs (right markers) dismiss their guards.	See also paragraphs 23 to 26.

Table 9B-3 (Sheet 2 of 2) The March Off

CHAPTER 10

GUARDS, SENTRIES AND ESCORTS

SECTION 1

GENERAL

INTRODUCTION

1. A guard is a body of troops concerned with the physical security of property or the security and honour of a dignitary. The strength of a guard is dependent on its task. For ceremonial purposes, it may be either:
 - a. a guard of honour, which is mounted for a dignitary (Section 2);
 - b. an entrance or departure guard, which may be mounted in lieu of a guard of honour for an arriving or departing dignitary (Section 3); or
 - c. a quarter guard (originally a quarters, barrack or camp guard, including a household guard for dignitaries such as the Governor General as head of state), which is mounted for a barrack, camp or building, but may also be used to pay compliments to a visiting dignitary (Section 4).
2. As a guide, a guard of honour is mounted:
 - a. on state occasions;
 - b. to formally receive a Commonwealth or foreign general officer when making an official visit to Canada; and
 - c. when it is desirable to provide a ceremonial welcome to Canadian dignitaries on very formal occasions, but a unit review is not appropriate or possible.
3. On other occasions, including family visits by Colonels-in-Chief, it is more normal to mount and call out a quarter guard if a ceremonial reception is desired.
4. An escort, other than an escort for or to a Colour (see chapters 8 and 9), is a body of mounted or dismounted troops concerned with the security and honour of a dignitary on the move. The strength of an escort is dependent on its task. Escorts are manpower-intensive and are now rarely used except for funerals (see Chapter 11) and, except in that context, are not discussed further in this manual.

COLOURS

5. Colours may be carried by an escort, guard of honour or household guard.

PARADE FORMAT

6. Guards will normally parade in two ranks, in line, with shoulder to shoulder dressing. However, the guard commander may vary this formation if necessary to fit the circumstances. For example, if the dimensions of the parade ground or space so dictate, a guard of honour may form up in column of divisions or sections. Since the strength of a guard is related to its task, the numbers on parade are more important than the formation adopted.
7. Guards shall pay compliments in review order (see Chapter 9, Section 2, paragraphs 13 to 17). Colours may be marched on parade directly into position in review order for guards of honour and household guards formed up in line, or for those in column of divisions when the officers are already in review order.

SECTION 2

GUARDS OF HONOUR

GENERAL

1. Guards of honour are mounted for distinguished personages and general officers in accordance with instructions issued in A-DH-200-000/AG-000, Honours, Flags and Heritage Structure of the CF soon to become A-DH-200-000/AG-000; The Heritage Structure of the CAF, Chapter 13, Annex A.
2. A 100-person royal or state guard of honour is composed of:
 - a. one major;
 - b. two captains or lieutenants;
 - c. one master warrant officer;
 - d. one warrant officer;
 - e. two sergeants; and
 - f. 96 corporals/privates.
3. A 50-person or general guard of honour is composed of:
 - a. one captain;
 - b. two captains or lieutenants;
 - c. one master warrant officer;
 - d. one warrant officer;
 - e. two sergeants; and
 - f. 48 corporals/privates.
4. If it is not practicable to provide a guard of honour of the strength as indicated above, the numbers may be reduced, provided that the reduction will not affect the honours to which the visiting personage is entitled. If numbers must be reduced by more than one-quarter, the commander should consider mounting a quarter guard in lieu.
5. On some occasions when a guard of honour would be appropriate but the unit's actual strength is too small to mount one, and the commander does not wish to mount a quarter guard in lieu, consideration should be given to parading the entire unit for review. Depending on the circumstances, the review ceremony could be abbreviated.

GUARD FORMATIONS

6. The guard shall form up in two divisions, as per company drill (Figure 10-2-1). The warrant and senior non-commissioned officers shall take posts in order of seniority as the:
 - a. right marker;
 - b. left marker;

- c. right marker of the left division; and
 - d. left marker of the right division.
7. Divisions of the larger guard may each be subdivided into two sections for ease of manoeuvre.
 8. If a band is in attendance, it should be positioned in the centre rear of the guard of honour, but, if space does not permit this, the band may be positioned on a flank.
 9. The band may be a military band, corps of drums (bugles), or pipes and drums. If both a military and other band are available, they may be combined, but only the military band will play for salutes.
 10. When individual movements are required of each division, words of command will be given by the division commanders in the same manner as for company drill.

FALLING IN THE GUARD

11. The master warrant officer shall fall in the guard as for company drill, with division left markers acting as platoon warrant officer/non-commissioned officers. The master warrant officer shall turn the guard over to the guard commander, who shall fall in the officers. The Colour or flags shall then be marched on, with compliments, as appropriate.
12. When the guard arrives opposite the centre of the dais, it shall be halted, turned to the front and formed into two ranks from three. The guard then shall open order and right (inwards) dress. Dressing shall be shoulder to shoulder, with no spaces left between divisions or sections, or between divisions and any Colour or flag party. Officers and Colours shall take post in review order. The guard shall then be stood at ease while awaiting the arrival of the personage for whom it has been mounted.
13. If the fall-in takes place in front of the dais and no march on is required, the guard may fall in, in two ranks, in review order.

MOUNTING THE GUARD OF HONOUR

14. When the personage for whom the guard of honour is mounted arrives, the guard commander shall order GUARD OF HONOUR, ATTEN – TION; and SHOULDER – ARMS.
15. When the personage has taken position on the dais, the guard commander shall give the command GUARD OF HONOUR, ROYAL (STATE) (GENERAL) SALUTE, PRESENT – ARMS. The band shall commence playing on the last movement of the present arms.
16. The guard commander next orders SHOULDER – ARMS; and ORDER – ARMS, and then marches to the personage, salutes, states his rank and name, and the name of the unit/base/station providing the guard of honour, and inquires if the personage wishes to inspect the Guard.
17. The Colours remain at the carry whenever the guard of honour orders arms.

INSPECTION

18. If the personage wishes to inspect the guard of honour, the inspection will be carried out as if the guard is a single unit rather than by divisions. Unless the personage expresses a personal wish to do otherwise, only the front of each rank is inspected, the personage proceeding right to left along the front rank and left to right along the rear rank. The inspecting party shall be as follows:

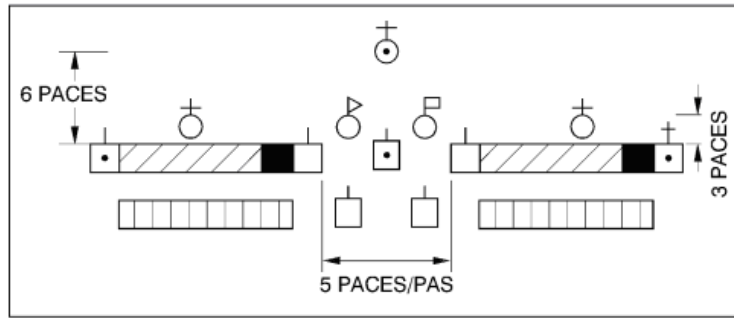

GUARD OF HONOUR WITH STAND OF COLOURS IN LINE IN REVIEW ORDER

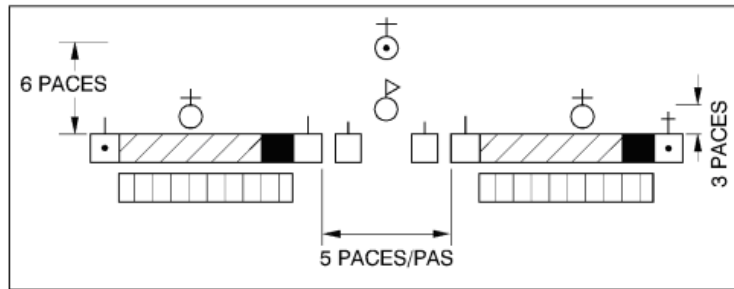

GUARD OF HONOUR WITH SINGLE COLOUR IN LINE IN REVIEW ORDER

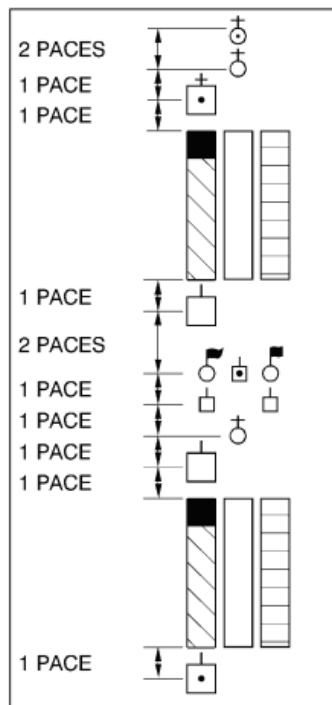

GUARD OF HONOUR WITH TWO COLOURS/FLAGS IN COLUMN OF ROUTE

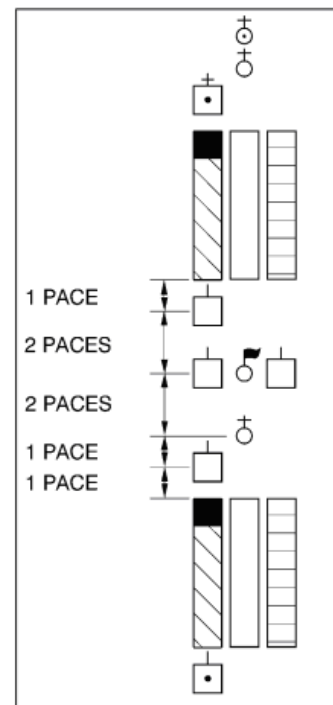

GUARD OF HONOUR WITH SINGLE COLOURS/FLAGS IN COLUMN OF ROUTE

Figure 10-2- 1 Guard of Honour Formations

- a. the honoured personage, shall be nearest the guard and the rank being inspected, otherwise the personage shall be on the guard commander's right;
- b. the guard commander, beside the personage; and
- c. in certain instances, the personage may have already been met and greeted officially by another dignitary, such as a Canadian Cabinet Minister for visiting foreign ministers. In such a case, the host dignitary might accompany the personage, walking immediately behind, with any fourth member of the entourage behind the guard commander. If the personage is Her Majesty The Queen, she has expressed her pleasure that only the guard commander will accompany her on an inspection.

19. When the personage arrives at the right flank to begin the inspection, the band shall commence playing appropriate music.

20. The Colour or National Flag is saluted on the march normally during the inspection of the front rank, i.e., the guard commander, with sword at the carry, turns head and eyes towards the Colour or National Flag.

21. Bands providing accompanying music for the ceremony are not usually inspected, nor conductors introduced, unless the visiting personage specifically requests.

22. On completion of the inspection of the guard of honour, the band shall cease to play and the guard commander shall accompany the visiting personage directly back to the dais, salute and return to his original position.

DISMOUNTING AND DISMISSAL

23. The guard may remain mounted if the personage carries out the scheduled activity at that location. For example, a guard of honour mounted for the Governor General at Parliament for the Speech from the Throne may remain mounted while the Governor General enters Parliament and delivers the speech; if the wait is lengthy, the troops may be stood at ease or even temporarily moved off the inspection location.

24. When its duty as a guard of honour is completed, either after the scheduled activity or immediately after the inspection, the guard shall pay departing compliments to the honoured personage. The guard commander shall order SHOULDER – ARMS; and GUARD OF HONOUR, ROYAL (STATE) (GENERAL) SALUTE, PRESENT – ARMS. The band will commence playing on the final drill movement. Upon completion of the salute, the guard commander shall order SHOULDER – ARMS.

25. The guard shall normally wait for the personage to depart before being marched off and dismissed. If the personage will be remaining in location and circumstances warrant, the guard may be marched past the visiting personage in either column of divisions (sections) or column of route as it leaves its place of duty.

SECTION 3

QUARTER GUARDS AND SENTRIES

GENERAL

1. In peacetime, quarter guards are usually mounted for ceremonial rather than functional purposes. The quarter guard may also be used to pay compliments to visiting dignitaries when insufficient personnel prevent the mounting of a guard of honour.

DEFINITIONS

2. **Sentry Post.** The location at which a single or double sentry is posted.

3. **Sentry Station.** The position where the sentry stands in front of his sentry box when not patrolling his beat.

4. **Grand Rounds.** The visits to a guard made by the Senior Duty Officer during his tour of duty. The guard is turned out and inspected by him.

5. **Visiting Rounds.** The visits to a guard made by the Duty Officer during his tour of duty. The guard is turned out and inspected by him.

COMPOSITION OF GUARDS

6. The strength of a quarter guard shall be dependent upon the number of single or double posts to be manned during a normal 24-hour period of duty. Each sentry remains on post for a period of two hours at four-hour intervals, and one or two spare members are provided (see Table 10-3-1).

7. Guards mounted for the purely ceremonial purpose of paying compliments to visiting dignitaries — that is, “ceremonial quarter guards” — shall be formed with the strength to man two posts with double sentries, that is, a total of 17 personnel.

8. In order to transmit the audible signals detailed in paragraphs 30 to 32, ceremonial sentries shall be armed with the C7 rifle only.

Serial	Number of Posts	Double Sentries	Single Sentries	Spares	Trumpeter/ Bugler	Guard commander	Guard Second in Command	Total Strength
Numéro	Nombre de postes	Postes doubles	Postes simples	Suppléants	Trompette ou clairon	Commandant de la garde	Commandant adjoint de la garde	Effectif total
1	3	18		2	1	1	1	23
2	2	12		2	1	1	1	17
3	1	6		1	1	1	1	10
4	3		9	1	1	1	1	13
5	2		6	1	1	1	1	10
6	1		3	1	1	1	1	7

Table 10-3- 1 Composition of Quarter Guards

9. The ceremonial quarter guard commander, a sergeant, is assisted by a second in command, usually the corporal of the guard, who is responsible for posting the sentries. The members of the guard are corporals and privates. In accordance with CAF custom, a trumpeter/bugler shall be included to sound official calls.

NOTE

In situations where the unit mounting the guard is organized and uniformed as a Scottish or Irish unit, and is authorized as pipe band, a piper may be ordered to augment the quarter guard to provide musical support other than official calls.

DUTIES OF THE GUARD

10. Duties of the guard shall be published in unit standing orders. Orders are to be read out loud to each sentry when being posted. These orders shall include:

- a. the reasons for which he is posted;
- b. the extent of his beat;
- c. the position of neighbouring posts; and
- d. any special orders not contained in unit standing orders.

11. A sentry with protective as well as ceremonial duties shall challenge suspicious persons or those approaching without clear authority to pass. The sentry shall port arms and carry out the normal tactical sequence of HALT; ADVANCE ONE AND BE RECOGNIZED; and password if needed. If permission to pass is granted, the sentry shall pay any appropriate compliments.

COMPLIMENTS

12. The guard shall be turned out (paragraphs 48 to 59):

- a. for armed parties, including armoured fighting vehicles;
- b. to pay compliments between reveille and retreat to general officers;
- c. to pay compliments once a day between reveille and retreat to the commanding officer;
- d. for grand rounds and visiting rounds;
- e. at reveille and retreat for inspection by the guard commander; and
- f. as directed by unit standing orders.

13. The guard shall not be turned out for unarmed parties.

14. Compliments shall be made as follows:

- a. **General Officers.** The guard shall be turned out and present arms. Sentries shall present arms.
- b. **Senior Officers (Colonels, Lieutenant-Colonels and Majors).** The guard shall present arms. Sentries shall present arms.
- c. **Junior Officers (Captains and Lieutenants).** The guard shall shoulder arms and the guard commander shall salute at the shoulder. Sentries shall be at the shoulder.

d. **Armed Parties**

- (1) To a battalion or equivalent, or a battery of artillery with its guns, the guard shall present arms.

- (2) To less than the above, the guard shall shoulder arms and the guard commander shall salute if applicable.
15. Sentries in sentry boxes shall pay compliments simply by coming to attention.
16. Sentries shall shoulder arms on hearing a national anthem. If in the vicinity of a guard which is presenting arms, they shall present arms in time with the guard.
17. A sentry patrolling his beat shall attempt to complete his patrol and halt at his station before paying compliments.
18. When a sentry is visited by a duty officer, the sentry shall salute and state his post number, i.e., "Post No. 1, Sir".
19. When both the old and new guard are on parade together, and it is necessary to pay compliments, words of command will be given to both by the senior rank on parade or in the case of both guards being commanded by persons of equal rank, by the commander of the old guard until the relief of sentries is complete, then by the new guard commander.

SENTRY DRILLS

20. When teaching sentry drills, verbal commands shall be prefixed with "AS A SENTRY". This indicates that several drill movements are being combined. The commands shown in this article are used for training sentries. The signals used as commands by double sentries are detailed in paragraphs 30 to 32.
21. A sentry normally takes station one full pace directly in front of his sentry box. He may take up a position inside the sentry box in inclement weather, both sentries on a double post working together.
22. When at his station and in his sentry box, a sentry stands at ease.
23. When on his beat, a sentry:
- a. marches with normal cadence in quick time at the shoulder arms;
 - b. turns outwards when turning at the end of his beat; and
 - c. stops marching only at his station.

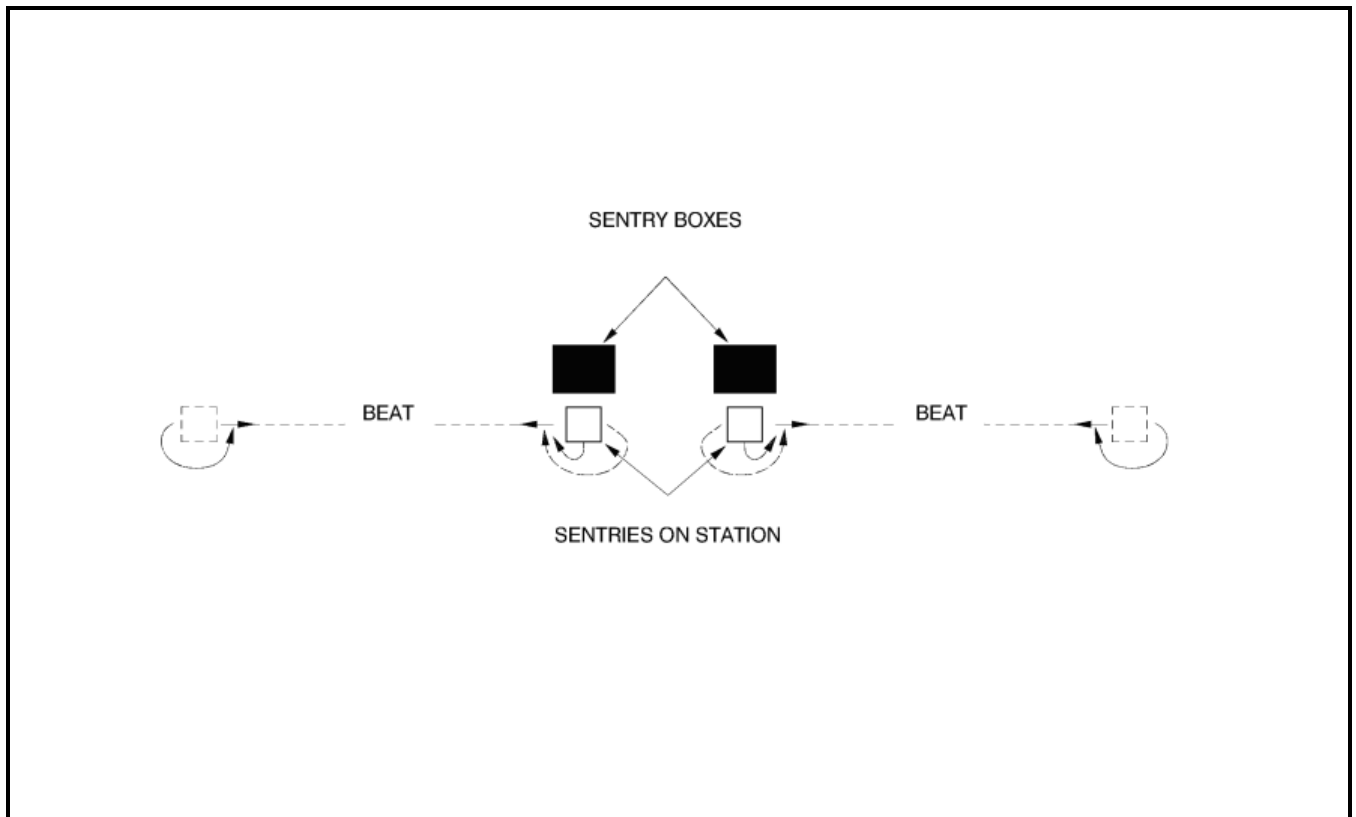

Figure 10-3- 1 Sentry Post with Double Sentries

24. On the command AS A SENTRY, TO THE FRONT – SALUTE, a sentry:
- standing at ease at his station comes to attention, shoulders arms, salutes, orders arms and stands at ease, observing a standard pause between each movement; and
 - patrolling his beat returns to his station, halts, turns to the front, salutes, orders arms, and stands at ease, observing a standard pause between each movement.
25. On the command AS A SENTRY, PRESENT – ARMS, the action detailed in paragraph 24 is carried out, except that the sentry presents arms instead of saluting at the shoulder.
26. On the command AS A SENTRY, TO THE RIGHT (LEFT), QUICK – MARCH, a sentry at his station comes to attention, shoulders arms, turns to the right (left), and steps off in quick time. A standard pause is observed between each movement. If in the sentry box, after coming to attention the sentry shall take one full pace forward out of the box and continue as detailed above.
27. On the command AS A SENTRY, ABOUT – TURN, given as the left foot is forward and on the ground, a sentry shall halt, turn outwards to the right (left), turn to the right (left) again to face the direction from which he came and step off in quick time in the new direction. A standard pause shall be maintained between all movements. Trained service personnel may turn about on the march; practice is necessary since all turns are outwards and thus some are left-about.
28. On the command AS A SENTRY, STAND AT – EASE, a patrolling sentry halts at his station, turns to face the front, orders arms and stands at ease. A standard pause is observed between each movement. If returning to position within the sentry box, after ordering arms the sentry shall take one full pace backwards and stand at ease.

DOUBLE SENTRIES

29. A double sentry consists of two sentries patrolling the same post (Figure 10-3-1). All their movements shall be executed together, taking the time from the senior (right hand) sentry. The senior is in command of the Post.

30. The senior sentry gives hand or audible signals to ensure coordinated drill movements by both sentries. The junior sentry shall give the signals only when an officer approaches the post from the left.

31. Hand signals are used by patrolling sentries. The signal is given when the sentries are facing each other, as the right foot is forward and on the ground, is repeated as the right foot comes to the ground again and the halt is executed on the next left foot. The hand signals, given with the left hand, are:

- a. one finger extended — stand at ease;
- b. two fingers extended — salute; and
- c. whole open hand extended — present arms.

32. Audible signals are used by sentries when stationary. The signals are given by tapping the rifle butt on the ground. The following signals are used, when the sentry is standing at ease:

- a. at his station:
 - (1) one tap — to the right (left) quick march,
 - (2) two taps — salute,
 - (3) three taps — presents arms, and
 - (4) four taps — one pace step back march.
- b. in his sentry box:
 - (1) two taps — attention or stand at ease,
 - (2) four taps — one pace forward march; and
- c. about to be relieved: one tap — shoulder arms.

FORMING UP THE GUARD

33. The guard shall fall in under command of the corporal of the guard, in a convenient area (Figure 10-3-2).

34. After the guard has been inspected by the corporal of the guard, it is then marched to the parade ground, the corporal marching in the rear. The sergeant shall proceed independently to the parade ground while the guard is being inspected.

35. On arrival at the parade ground, the guard is halted at a pre-arranged position and remains at the shoulder arms.

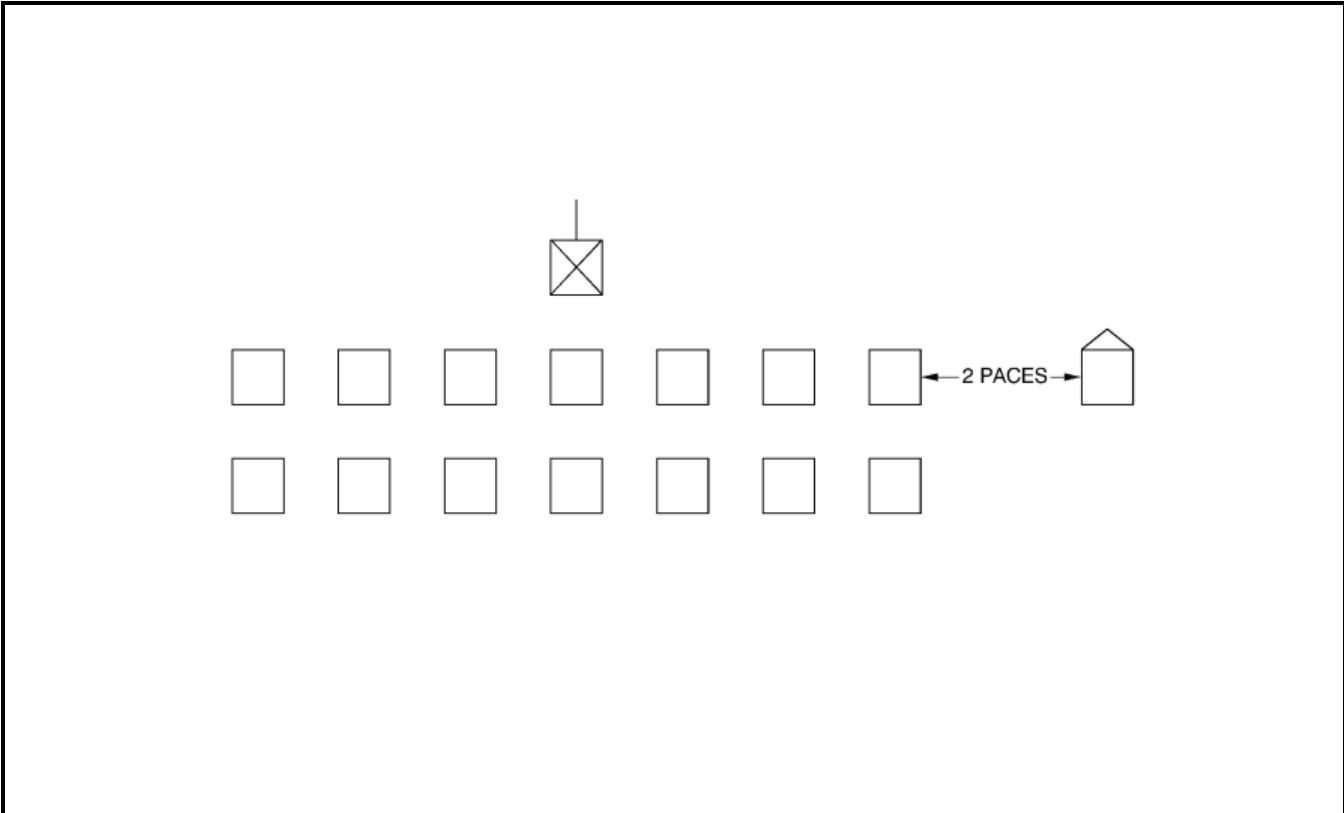

Figure 10-3- 2 Guard Formed up under the Corporal of the Guard

36. The corporal reports to his sergeant and then falls in on the left of the front rank. The sergeant, in turn, reports to the duty sergeant and then falls in on the right flank of the guard (Figure 10-3-3).

37. The duty sergeant reports to the chief warrant officer (CWO) and then marches to a position six paces to the right of the guard sergeant, orders the guard to order arms and stand at ease. He turns to the front and stands at ease. The CWO then moves to a position 24 paces in front of the guard sergeant and turns, facing him.

38. Under some circumstances, there may be more than one guard; for example, a battalion's duties for the next 24-hour period might include a household guard, a quarter guard for the barracks and a picquet (such as a fire picquet). In that case, they shall parade in that order of precedence, normally in column, and the duty sergeant shall wait until all are present before reporting to the CWO. Company drill shall be used where applicable. The guards, when ordered to their duties shall take independent routes after they march past the adjutant as noted in Table 10-3-2, items 30 to 33.

GUARD MOUNTING

39. The procedure for guard mounting is detailed in Table 10-3-2:

No.	Command	By	Action	Remark
1	GUARD COMMANDER(S) (or Sergeant(s), non-commissioned officer(s) for Guard if household guards are to be subsequently commanded by officers; see No. 29)	CWO	The Guard Commander (Gd Comd) and the Duty Sergeant (Sgt) come to attention. The Gd Comd shoulders arms and, with the Duty Sgt, marches forward 15 paces and halts. The Gd Comd orders arms. Both remain at attention.	The CWO moves forward and inspects the Gd Comd and returns to his position, nine paces in front of and facing the Gd Comd. Only household guards (see paragraphs 63 to 69) are commanded by officers.
2	GUARD COMMANDER, FOR INSPECTION EXAMINE – ARMS	CWO	The Gd Comd acts as ordered.	The CWO inspects the Gd Comd's rifle and returns to his position, as in Item 1.
3	GUARD COMMANDER, EASE – SPRINGS	CWO	The Gd Comd eases springs.	
4	GUARD COMMANDER, ORDER – ARMS	CWO	The Gd Comd orders arms.	If more than one guard or detachment is paraded for inspection, commanders will be ordered to adopt duties distance.
5	GUARD COMMANDER, STAND AT – EASE	CWO	The Gd Comd and Duty Sgt stand at ease.	The CWO turns to his right and marches to a position nine paces in front and centre of where the guard will fall in, halts and turns left.
6	GUARD, FALL – IN	CWO	The Gd Comd, Duty Sgt, bugler and guard come to attention. The Gd Comd and guard shoulder arms. The guard and bugler march forward 15 paces and halt with the bugler one pace to the right of the Gd Comd (see Figure 10-3-4).	The band, when present for ceremonial guards, takes up a position 24 paces to the right and in line with the guard.
7	GUARD, ORDER – ARMS	CWO	The guard orders arms.	
8	GUARD, OPEN ORDER – MARCH	CWO	The guard acts as ordered.	

Table 10-3-2 (Sheet 1 of 11) Guard Mounting

No.	Command	By	Action	Remark
9	GUARD, RIGHT – DRESS	CWO	The Gd Comd stands steady. The guard dresses to the right. The bugler dresses on the Gd Comd.	The Duty Sgt turns left and dresses each rank of the guard normally.
10	GUARD, EYES – FRONT	CWO	All act as ordered.	The Duty Sgt returns to his original position.
11	GUARD WILL FIX BAYONETS – FIX	CWO	Guard fixes bayonets.	The Gd Comd and the Duty Sgt stand fast.
12	GUARD BAYO – NETS	CWO	As ordered.	
13	GUARD, ATTEN – TION	CWO	As ordered.	The Adjutant (Adjt) positions himself two paces in rear of the CWO. The CWO turns about, salutes and reports the guard present and ready for inspection to the Adjt. Upon being ordered to fall in the CWO salutes, and marches to the rear of the Adjt, passing on his right. The Adjt takes two paces forward and the CWO, by a series of wheels, position himself three paces in rear of the Adjt. Upon the CWO's halting, after a standard pause, the Adjt and CWO step off together, inspect the guard and return to their original position. During inspection the band, if present, will play appropriate music.
14	GUARD WILL UNFIX BAYONETS – UNFIX	Adjt	Guard unfixed bayonets.	The Duty Sgt and Gd Comd stand fast.
15	BAYO – NETS	Adjt	As ordered.	
16	GUARD, ATTEN – TION	Adjt	As ordered.	

Table 10-3-2 (Sheet 2 of 11) Guard Mounting

No.	Command	By	Action	Remark
17	GUARD, FOR INSPECTION, EXAMINE – ARMS	Adjt	The guard acts as ordered.	The Gd Comd shoulders arms, his rifle having been previously inspected. The Adjt and CWO step off together, inspect the guard's rifles and return to their original position.
18	GUARD, EASE – SPRINGS	Adjt	Guard eases springs.	
19	GUARD, ORDER – ARMS	Adjt	Guard orders arms. The Gd Comd orders arms from the shoulder arm position.	Having been found ready for duty, the guard will be addressed as the “new guard” from this point in the ceremony.
20	NEW GUARD WILL FIX BAYONETS – FIX	Adjt	Guard fixes bayonets.	Gd Comd and Duty Sgt stand fast.
21	BAYO – NETS	Adjt	As ordered.	
22	NEW GUARD, ATTEN – TION	Adjt	As ordered.	
23	NEW GUARD, SHOULDER – ARMS	Adjt	As ordered.	
24	NEW GUARD, CLOSE ORDER – MARCH	Adjt	As ordered.	
25	NEW GUARD, RIGHT – DRESS	Adjt	As ordered.	As in Item 9.
26	NEW GUARD, EYES – FRONT	Adjt	As ordered.	As in Item 10.
27	CHIEF WARRANT OFFICER, DISMISS THE DUTY SERGEANT	Adjt	The CWO acknowledges this order by saluting, the Adjt returning the salute.	The CWO may be addressed by rank, name or appointment.

Table 10-3-2 (Sheet 3 of 11) Guard Mounting

No.	Command	By	Action	Remark
28	DUTY SERGEANT, DIS – MISS	CWO	The Duty Sgt turns to his right, salutes, steps off, wheels to his right and marches off the parade ground.	The Adjt acknowledges the salute.
29	GUARD COMMANDER, TAKE – POST or GUARD COMMANDER(S) FALL – IN (if officers are to command guards)	Adjt	<ol style="list-style-type: none"> <li data-bbox="643 449 1013 816">1. The Gd Comd and the Corporal (Cpl) of the guard step off together, in quick time, wheel outwards, the Gd Comd moving to a position three paces in centre rear of the guard. The Cpl of the guard, marching in rear of the Gd Comd, moves into the Gd Comd's former position as right guide of the guard. <li data-bbox="643 842 1013 1110">2. If guards are commanded by officers, their place will be three paces in front of the centre of their guards, and the non-commissioned officers will not change posts. Officers draw swords on the Adjt's command "FALL – IN". 	As the Gd Comd and the Cpl of the guard move into new positions, the Adjt and CWO turn left and march to a point nine paces clear of the right flank of the guard and turn about (see Figure 10-3-5). At the same time, the band, if present, moves to a position 20 paces in front of the guard.
30	NEW GUARD, TO YOUR DUTIES, BY THE RIGHT, QUICK – MARCH	Adjt	The guard and band step off together, the band playing.	
31	NEW GUARD, EYES – RIGHT	Guard Comd	The bugler and the right hand non-commissioned officer of the guard look to their front, the remainder look to the right, Gd Comd saluting as with a rifle. (If an officer commands the guard, the sword will be held at the carry and the head and eyes turned to the right; non-commissioned officers will not salute with rifles.)	The Adjt salutes until the guard has cleared his front.

Table 10-3-2 (Sheet 4 of 11) Guard Mounting

No.	Command	By	Action	Remark
32	NEW GUARD, EYES – FRONT	Guard Comd	All act as ordered.	The Adjt moves off the parade ground, accompanied by the CWO, to await the subsequent arrival of the old guard (see paragraph 40).
33	The new guard marches to the guard room to relieve the old guard. The guard shall march in line, forming to change direction if possible; if not, in file.			
34	STAND BY THE – GUARD	Sentry of the Old Guard		See paragraphs 48 to 59. The guard may fall in according to routine timings.
35	GUARD, TURN – OUT	Sentry of the Old Guard	As ordered.	The guard turns out on the double at the port, bayonets fixed, and falls in at the open order, shouldering arms and dressing automatically. The bugler falls in one pace to the right of the Old Guard Comd.
36	NEW GUARD – HALT	New Guard Comd	New guard halts.	When the ground permits, the new guard is halted 15 paces opposite the old guard facing it. When this is not possible, the new guard is positioned six paces on the left and in line with the old guard, facing the same direction. Sentries within hearing of the Old Guard Comd, conform to the actions of their guard during the relief. The band takes up its position clear of the ground to be occupied by the guards during the relief and plays appropriate music.
37	NEW GUARD, OPEN ORDER – MARCH	New Guard Comd	As ordered.	

Table 10-3-2 (Sheet 5 of 11) Guard Mounting

No.	Command	By	Action	Remark
38	NEW GUARD, RIGHT – DRESS	New Guard Comd	Guard dresses to the right, the right flank personnel maintaining their head and eyes to the front.	The Guard Comd or the Guard Warrant Officer/Sgt if the guard is commanded by an officer, steps off and positions himself six paces to the right of the front rank, halts and turns left. The Cpl of the guard, unless already on the left flank, steps off and, by a series of wheels, proceeds around the rear of the guard, passing on the right of the Guard Comd to his original position one pace to the left of the front rank. The guard is dressed.
39	NEW GUARD, EYES – FRONT	New Guard Comd	The guard act as ordered.	The Guard Comd or Warrant Officer/Sgt moves to his position one pace to the right of the front rank of the guard.
40	OLD GUARD, TO THE NEW GUARD, PRESENT – ARMS	Old Guard Comd	Old guard presents arms.	
41	NEW GUARD, TO THE OLD GUARD, PRESENT – ARMS	New Guard Comd	New guard present arms.	The bugler of the new guard sounds the “General Salute”.
42	OLD GUARD SHOULDER – ARMS	Old Guard Comd	Old guard shoulders arms.	
43	NEW GUARD SHOULDER – ARMS	New Guard Comd	New guard shoulder arms.	
44	OLD GUARD, ORDER – ARMS	Old Guard Comd	Old guard including comd, orders arms.	

Table 10-3-2 (Sheet 6 of 11) Guard Mounting

No.	Command	By	Action	Remark
45	NEW GUARD, ORDER – ARMS	New Guard Comd	New guard, including Comd, orders arms.	The Old Guard Comd then states the number of sentries posted, e.g. two by day, four by night. The New Guard Comd repeats the number of sentries posted. Household Guard comds may exchange keys.
46	OLD GUARD, STAND AT – EASE	Old Guard Comd	Old guard stands at ease.	The Old and New Guard Comds then shoulder arms, step off and position themselves three paces in front and centre of their guards, the Old Guard Comd facing the front, the New Guard Comd facing his guard.
47	NEW GUARD, AS A GUARD – NUMBER	New Guard Comd	The new guard numbers off from front to rear, starting at the right flank, as shown in Figure 10-3-6.	The New Guard Comd then tells off his guard by reliefs, e.g. Nos. 1 to 4 first relief, etc.
48	MARCH OFF FIRST RELIEF, REMAINDER STAND AT – EASE	New Guard Comd	Nos. 1 to 4 (or as detailed for First Relief) remain at attention; the remainder stand at ease.	Following this command, the Old and New Guard Comds turns towards and move off to handover the guard room. The Cpl of the new guard shoulders arms and places himself three paces in front and centre of the new guard and remains at the shoulder.
49	FIRST RELIEF, SHOULDER – ARMS	New Guard Cpl	First Relief shoulder arms.	The Cpl of the Old Guard who will guide the relief to its posts, steps off and positions himself one pace to the right flank of the first relief. The Cpl of the New Guard steps off and positions himself three paces in front and centre of the first relief.

Table 10-3-2 (Sheet 7 of 11) Guard Mounting

No.	Command	By	Action	Remark
50	FIRST RELIEF, MOVE TO THE RIGHT IN FILE, RIGHT – TURN	New Guard Cpl	First Relief turns right.	
51	FIRST RELIEF, QUICK – MARCH	New Guard Cpl	The Relief steps off and the new guard Cpl moves one pace to the left of the last number.	The old guard Cpl leads the first relief to No. 1 post by the most direct route.
52	RELIEF – HALT	New Guard Cpl	The relief halts.	The old guard sentry shall come to attention and shoulder arms as the relief approaches.
53	NO. 1 SENTRY, TAKE – POST	New Guard Cpl	The new sentry then steps off and position himself one pace on the left of the old sentry and turns about.	Both Cpls move to a position in front of the sentries. The old guard cpl reads the sentry's orders and ensures they are understood.
54	SENTRIES – PASS	New Guard Cpl	The old sentry steps off directly ahead and, by a series of wheels, positions himself in rear of the relief.	As the old sentry steps off, the new sentry takes post by taking two paces right close. The Cpls return to their former positions and carry on as detailed in Nos. 51 to 54 inclusive, until all posts are relieved.
55	When all sentries are posted, the guard Cpls change positions; the old guard Cpl assuming command.			
56	OLD SENTRIES, QUICK – MARCH	Old Guard Cpl	As ordered.	The old sentries return to the guard room location. The new guard Cpl, acting on his commands, will lead the old sentries back by the most direct route.
57	OLD SENTRIES – HALT	Old Guard Cpl	The old sentries are halted between the two guards.	The old sentries are then turned to face the same direction as the old guard.

Table 10-3-2 (Sheet 8 of 11) Guard Mounting

No.	Command	By	Action	Remark
58	OLD SENTRIES, FALL – IN	Old Guard Cpl	The old sentries and the two Cpls turn right and, after a standard pause, move to their positions with their respective guards, order arms and stand at ease.	The old sentries fall in on the left of the old guard and the two Cpls on the left of their respective guards.
59	When the handover between the Guard Comds and the posting of the first relief are completed, the Guard Comds fall in on the right of their respective guards. The band, if in attendance, will move to a position so that it can precede the old guard when it marches off.			
60	OLD GUARD, ATTEN – TION	Old Guard Comd	The old guard comes to attention.	
61	NEW GUARD, ATTEN – TION	New Guard Comd	The new guard comes to attention.	
62	OLD GUARD, SHOULDER – ARMS	Old Guard Comd	The old guard shoulders arms.	
63	NEW GUARD, SHOULDER – ARMS	New Guard Comd	The new guard shoulders arms.	If officers are not in command of the guards, following the completion of the shoulder, the Old Guard Comd and Cpl step off and position themselves as detailed in No. 29.
64	OLD GUARD, CLOSE ORDER – MARCH	Old Guard Comd	The old guard moves to close order.	

Table 10-3-2 (Sheet 9 of 11) Guard Mounting

No.	Command	By	Action	Remark
65	OLD GUARD, CHANGE DIRECTION RIGHT (LEFT), RIGHT (LEFT) – FORM; QUICK – MARCH; FOR – WARD	Old Guard Comd	The old guard acts as ordered.	This procedure will be used when guards are opposite each other.
65a	Other circumstances			If the old guard is in line it may be marched off directly to the front or in other circumstances, it may be turned to the right and, after stepping off, execute two left wheels and marched across the frontage of the new guard. In all cases, the band, if present, commences to play on the command "MARCH". If local custom dictates, the old guard may depart in slow time, changing into quick time when clear of the guardroom or gate.
66	NEW GUARD TO THE OLD GUARD, PRESENT – ARMS	New Guard Comd	The new guard, including the Guard Commander, present arms.	
67	OLD GUARD, EYES – RIGHT (LEFT)	Old Guard Comd	The Old Guard Comd salutes, the remainder turn their head and eyes to the right (left).	
68	OLD GUARD, EYES – FRONT	Old Guard Comd	As ordered.	See paragraph 40.

Table 10-3-2 (Sheet 10 of 11) Guard Mounting

No.	Command	By	Action	Remark
69	NEW GUARD, SHOULDER – ARMS	New Guard Comd	The new guard shoulders arms.	
70	NEW GUARD, CLOSE ORDER – MARCH	New Guard Comd	The new guard moves to close order.	If the guard is commanded by an non-commissioned officer, the Guard Comd and Cpl take post. The Guard Comd moves the guard to the position vacated by the Old Guard and explains the procedure for turning out. This and other orders are reviewed. The same information will be explained to the First Relief when they come off sentry duty.
71	GUARD, TO THE GUARD ROOM, DIS – MISS	Guard Comd	The guard acts as ordered. If an officer is present, guard members will all salute at the shoulder.	The old guard having departed, the new guard is simply referred to as the "guard".

Table 10-3-2 (Sheet 11 of 11) Guard Mounting

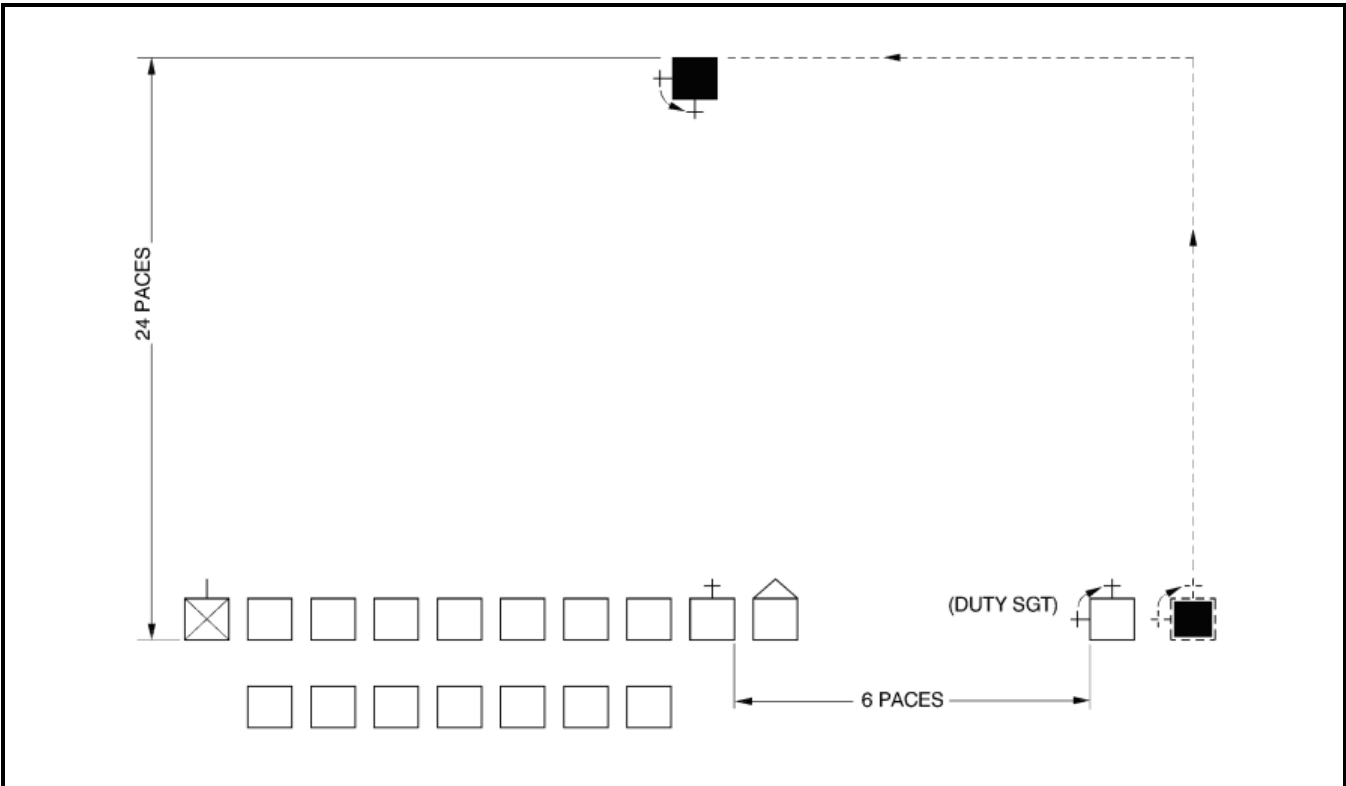

Figure 10-3- 3 Guard Formed up Ready for Mounting

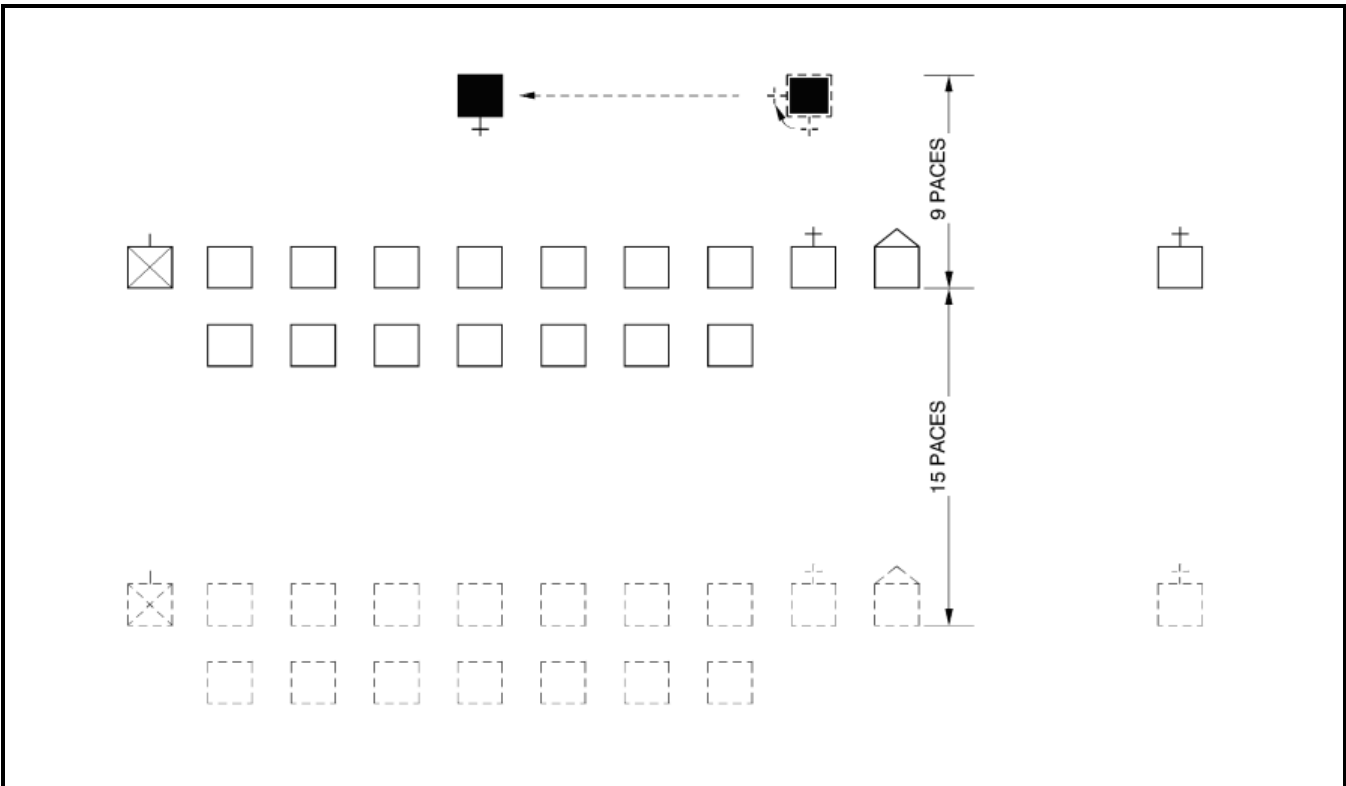

Figure 10-3- 4 Guard Mounting (No. 6)

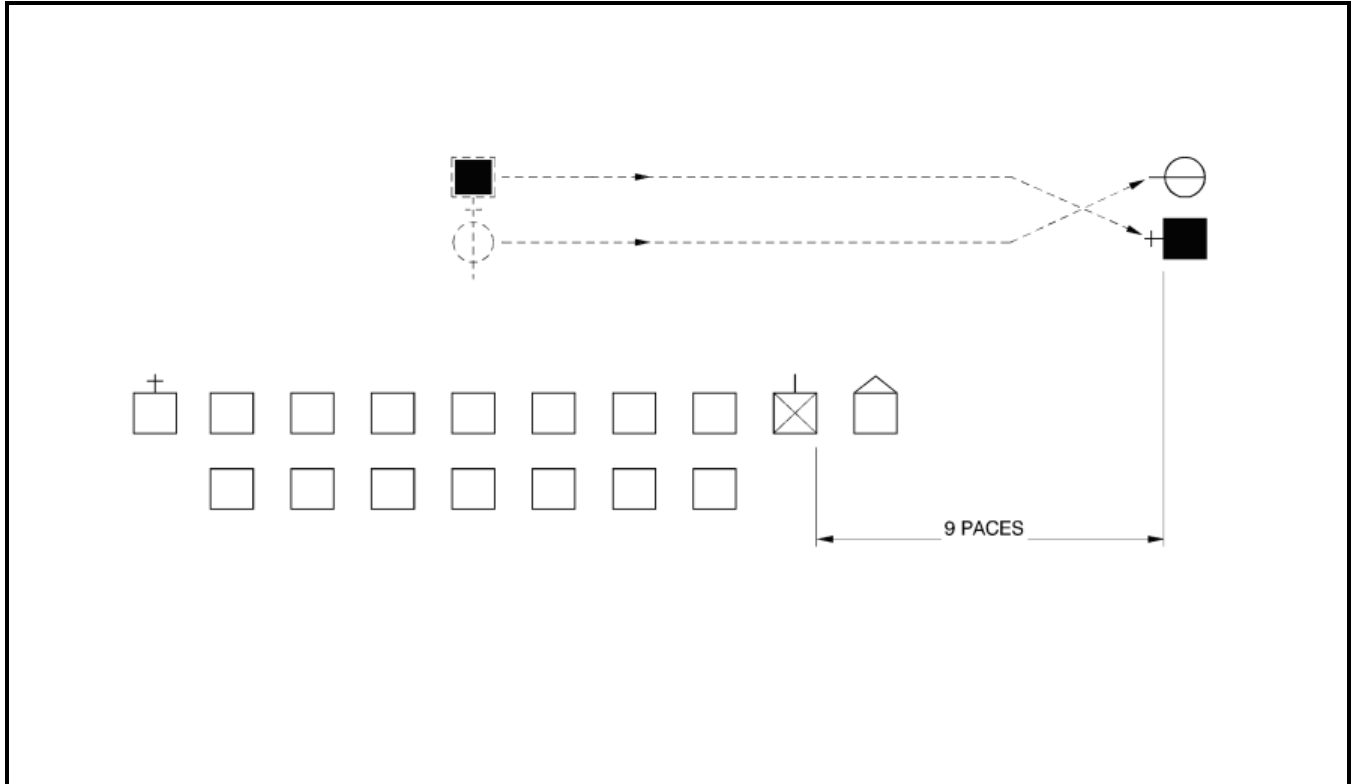

Figure 10-3- 5 Guard Mounting (No. 29)

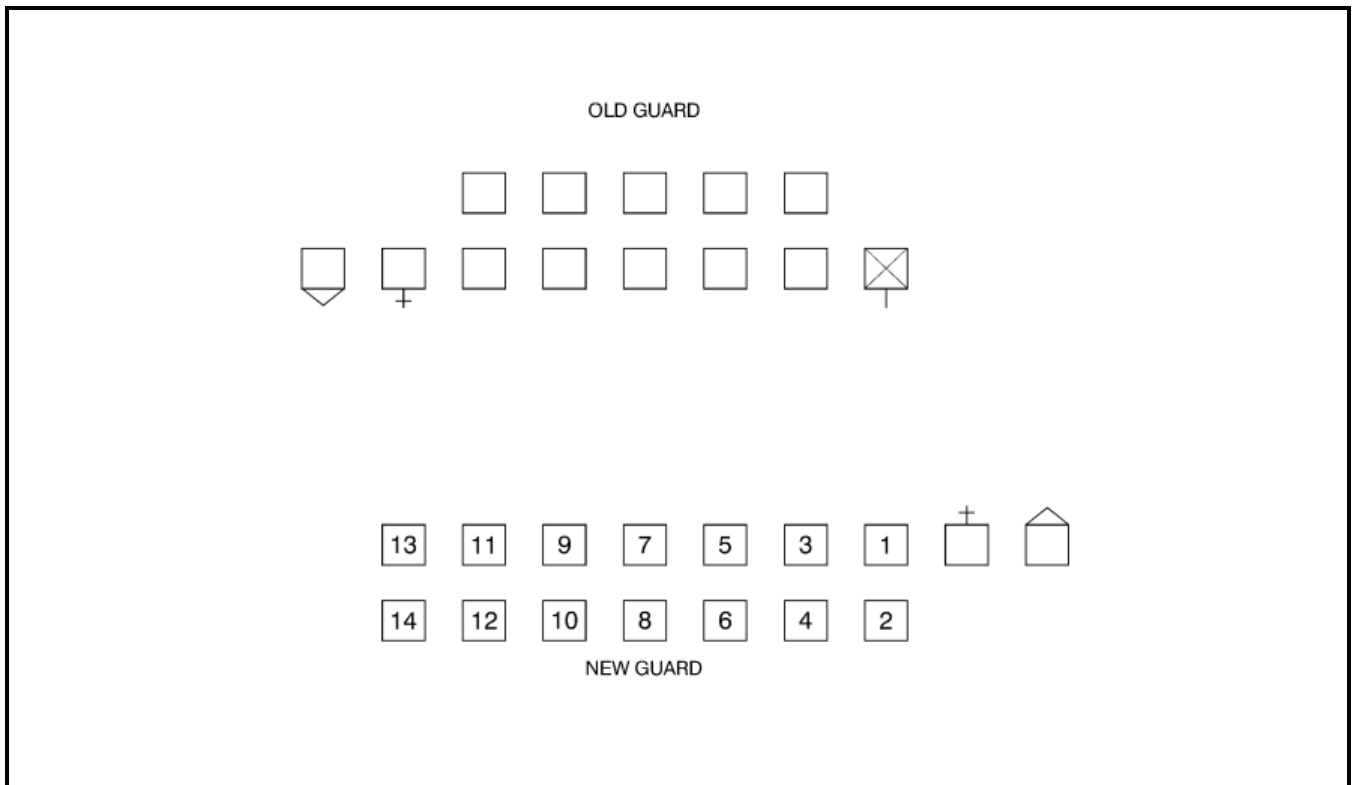

Figure 10-3- 6 Guard Mounting (No. 47)

40. After the new guard is mounted, the old guard marches to the parade ground and occupies the position formerly occupied by the new guard during the inspection by the adjutant. When halted in this position, the guard commander orders his guard to order arms and open order and right dress.

41. If the guard commander is not an officer, the commander moves to a position six paces to the right of the front rank, halts and turns left. The corporal moves to his position on the left of the front rank. The guard is dressed.

42. The guard commander will order eyes front, and report to the adjutant, who by then is in position in front of the guard. Simultaneously, unless the guard commander is an officer, the corporal of the guard shoulders arms and moves in rear of the guard to take post on the right of the front rank. The old guard is inspected by the adjutant in the same manner as for the new guard, except that the guard commander accompanies the adjutant during the inspection. The adjutant does not order the guard to fix bayonets. After the inspection, the adjutant marches off the Colours and falls out the officers if applicable (i.e., for household guards), or orders the non-commissioned officer guard commander to take post. The adjutant marches to a point clear of the right flank of the guard.

43. The adjutant orders the warrant officer and sergeant of the guard or guard commander to march the guard to the company area and dismiss it. The guard commander proceeds as ordered, marching past the adjutant and giving an EYES – RIGHT and EYES – FRONT.

POSTING AND RELIEVING SENTRIES

44. Sentries shall be posted or relieved by the corporal of the guard as detailed in Table 10-3-2, Nos. 49 to 56 inclusive, excluding the actions of the old guard corporal. The sentry's orders will be read by the corporal of the guard.

45. Reliefs are inspected at the guard room prior to being posted.

46. When a sentry is to be posted at a new post which does not yet have a sentry, the sentry is halted when at a point five paces in front of the station. On the command TAKE – POST, the sentry marches five paces, halts at his station and turns about.

47. When relieved, sentries are marched to the guard room, halted and inspected by the corporal who will then order TO THE GUARD ROOM, DIS – MISS. The sentries act as ordered.

TURNING OUT THE GUARD

48. The sentry on the post nearest the guard room warns the guard commander and the guard of the approach of persons for whom the guard will turn out (see paragraphs 12 to 19) by calling STAND BY THE GUARD. The guard prepares to turn out.

49. If the sentry is on beat when he calls the warning, he completes the tour of his beat and then calls GUARD, TURN – OUT.

50. The guard turns out at the double at the port, bayonets fixed, forms up at the open order, rifles at the shoulder and dresses automatically. The senior warrant officer or Sergeant of the guard does not fix his bayonet.

51. Sentries within hearing distance of the guard commander halt at their stations and act on the guard commander's orders.

52. Guards mounted for the purely ceremonial purpose of paying compliments to visiting dignitaries may post their sentry outside the guard room. If the guard room area or main gate site does not have sufficient space for the ceremony, the guard may be formed up at a location deemed suitable. In this case the instructions in paragraphs 48 to 50 above do not apply and the guard is simply positioned in line prior to the arrival of the dignitary.

53. The guard commander orders GUARD, GENERAL (ROYAL) SALUTE, PRESENT – ARMS as the dignitary arrives in front of the guard. For purely ceremonial guards, a position approximately 10 paces in front (centre) of the guard may be marked or a low dais may be erected for this purpose.

54. The guard commander orders SHOULDER – ARMS and reports the guard ready for inspection from his position on the right flank. If the dignitary wishes to inspect, he will step off at this time; the guard commander will remain at his position unless requested by the dignitary to accompany him. If the dignitary does not wish to inspect, he will say so. (It is usual for a non-military dignitary to arrive in company with a member of the unit being visited, who will brief the dignitary on this procedure beforehand as a matter of common courtesy.)

55. If the dignitary chooses to inspect the guard and asks the guard commander to accompany him, the guard commander will be on the dignitary's right for the front rank and on his left for the rear rank.

56. On completion of the inspection, the dignitary returns to the reviewing position or dais. If the guard commander has accompanied him, the guard commander returns to his position on the right flank of the guard.

57. The guard commander orders GUARD, GENERAL (ROYAL) SALUTE, PRESENT – ARMS and SHOULDER – ARMS. The dignitary then leaves the area.

58. A dignitary passing a working guard at the entrance to a barracks or other location, may choose to acknowledge the compliment without stopping. In this case, the guard then completes its compliment normally after the dignitary has passed by.

59. If the guard is turned out for rounds, the duty officer may choose to inspect the guard room, cells, etc. If so, he shall request the guard commander to accompany him.

DISMISSING THE GUARD

60. After the dignitary or duty officer departs, the guard commander orders TO THE GUARD ROOM, DIS – MISS. The guard acts as ordered.

61. Purely ceremonial guards formed up in other locations, as noted in paragraph 52, may simply be dismissed if appropriate.

62. The duty officer may also request the guard commander to dismiss the guard after the inspection.

HOUSEHOLD GUARDS

63. Household guards parade and work in the same manner as quarter guards, except as noted below.

64. Since household guards are mounted for a dignitary, their composition and size will be dependent on the dignitary's rank in the same manner as for guards of honour (see Table 10-2-1), rather than the number of posts to be manned. When the dignitary is not present at the household, the size of the guard may be reduced, so long as it is not reduced below that required to man the posts.

65. Household guards, like guards of honour, shall be commanded by officers and shall carry Colours if appropriate for the unit concerned. For units possessing a stand of Colours, only one Colour

shall be carried: the Queen's Colour for Royal, Vice-Regal and Head of State guards when the dignitary is actually present in the household; and the Command/College/Regimental Colour on other occasions.

66. Household guards shall be mounted as detailed in Table 10-3-2. New guard officers shall be fallen in and old guard officers fallen out by the adjutant at the appropriate time in the ceremony.

67. If both the new and old guards are found by the same unit which possess a stand of Colours, each guard may carry a Colour. To ensure that the guard on duty holds the appropriate Colour, they may have to be exchanged at the time of relief along with keys, duty lists, etc.

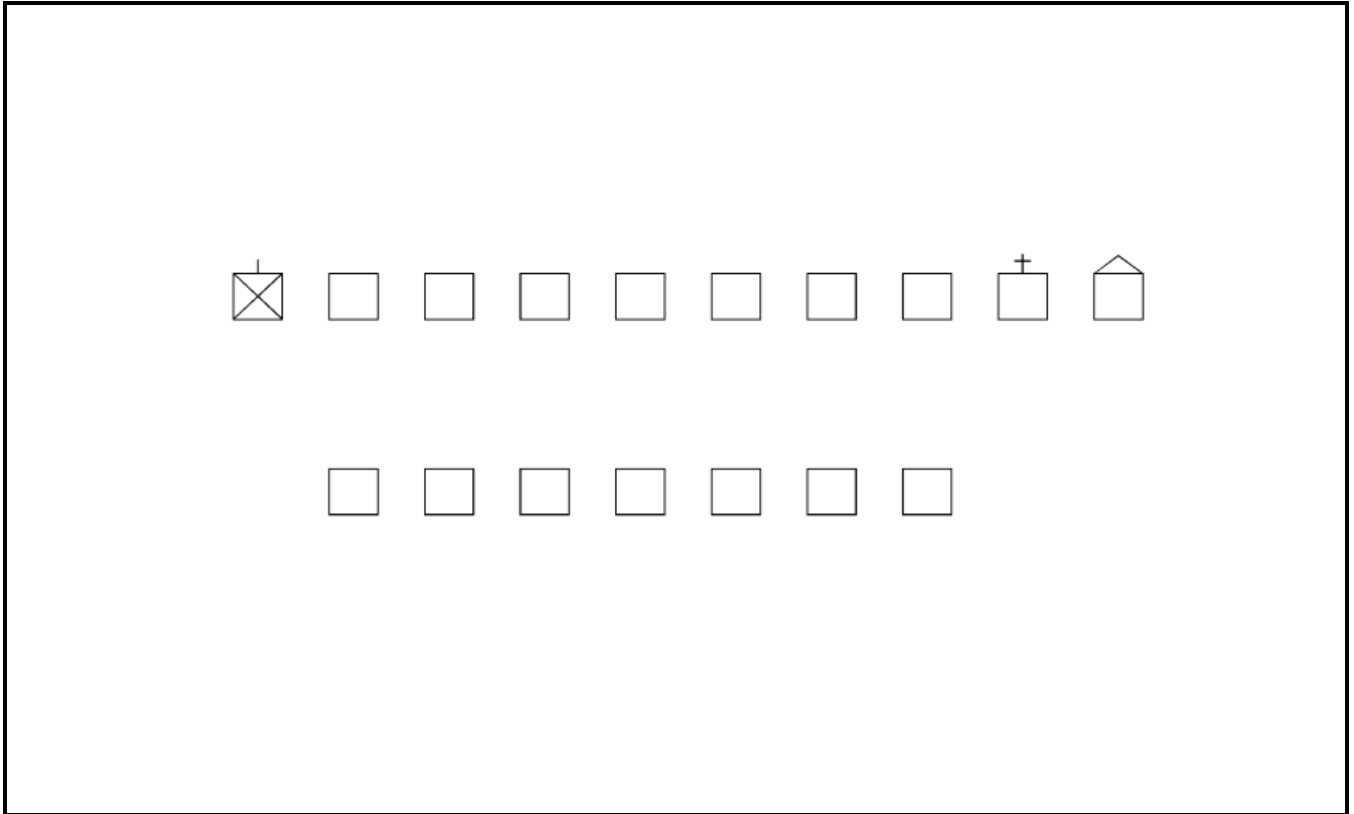

Figure 10-3- 7 Quarter Guard after Being Turned out

68. Once the new guard has taken up its duties and turned in to the guard room, the Colour shall be lodged with the junior officer of the guard. Junior non-commissioned officers or other selected members of the guard shall act as Colour escorts; when not escorting the Colour, they shall be positioned in one file of the guard.

69. The guard will turn out in a size commensurate with the rank of the person being honoured. Standing orders shall detail the size of the guard or guard detachment, in each case.

SECTION 4

CEREMONIAL ARRIVAL AND DEPARTURE GUARDS

GENERAL

1. Ceremonial arrival guards may be mounted to line on entrance, stairway or corridor for dignitaries entering a building, or the last few meters of a departing dignitary's exit route. They shall not be mounted when a guard of honour has been ordered for the occasion.
2. Ceremonial arrival and departure guards may be armed or unarmed.

CEREMONIAL ARRIVAL GUARD

3. Guards may be positioned to line a building's entrance, stairway or corridor for any personage to whom a quarter guard would turn out in a normal context (see Section 3, paragraph 11).
4. Ceremonial arrival guards shall be sized for their task. If the space to be lined is suitable, its composition is that of a ceremonial quarter guard (see Section 3, paragraph 7). Fewer personnel can be used if space is limited, i.e., when lining a short stairway. If alerts and salutes are to be sounded, the bugler/piper should be stationed near the doorway or entrance. If a band is present or no alerts or salutes are to be sounded, the bugler/piper may be omitted.
5. Ceremonial arrival guards are normally only provided on state occasions, i.e., at Rideau Hall, the Governor General's residence in Ottawa, for a reception for a visiting head of state or for investiture.

DEPARTURE GUARD

6. A departure guard may be mounted to pay final compliments to a military or civilian dignitary leaving by air, sea, rail or motor car. Departure guards shall only be mounted for personages entitled to a guard of honour (Table 10-2-1).
7. The composition of a departure guard is that of a ceremonial quarter guard (see Section 3, paragraph 7) commanded by a junior officer and assisted by a sergeant, less the bugler/piper; that is, one junior officer, one sergeant and 14 corporals and privates.

POSITIONING THE GUARD

8. The guard shall be formed up in two ranks and marched to the site.
9. Upon arrival, the guard shall be halted in position or, for stairways and corridors, along the length of the passageway in pre-arranged positions or as for street lining (see Chapter 12).
10. For a vehicle or other doorway, the guard shall be halted so that the front rank is in line with the right side of the doorway. For a departure guard at an aircraft, alignment is with the right side of the boarding ramp and no closer to the aircraft than the wing tip (see Figure 10-4-1). The guard commander shall then order **GUARD ADVANCE, LEFT – TURN; REAR RANK, STAND – FAST; FRONT RANK, THREE PACES FORWARD – MARCH; and FRONT RANK, ABOUT – TURN.**
11. The guard shall then be dressed by the commander ordering **REAR RANK RIGHT, FRONT RANK LEFT – DRESS.** The marker and the right-hand individual of the rear rank will ensure they are directly opposite each other. For a departure guard at an aircraft, the right-hand individual of the rear rank will ensure that the ranks are positioned outside the aircraft's wing tip.
12. After the command **GUARD, EYES – FRONT** has been given, the guard, if carrying arms, shall be given the command **ORDER – ARMS** and then stood at ease to await the arrival of the personage for whom the guard has been mounted.

13. For a ceremonial arrival guard, the guard commander shall take post nearest the entrance on the right hand side of the dignitaries as they enter. The second in command shall take post on the opposite flank and opposite side. If a ceremonial arrival guard is maintained in place to pay compliments when the dignitaries leave the building, the commander and second in command shall change sides to place the former on the right hand side of the dignitaries as they leave.

14. For a departure guard, the guard commander shall take post on the right flank of the rear rank, i.e., on the right hand side of the departing personage; the sergeant on the opposite flank of the front rank, nearest the personage's arrival point, facing in the opposite direction from the commander.

15. The band, if in attendance, should be positioned in the most suitable location.

16. For a departure guard, the following flags shall be flown from two staffs as shown in Figure 10-4-1:

- a. the National Flag of Canada; and
- b. either the national flag of the departing personage's country or, if the latter is not applicable, the Canadian Armed Forces Ensign or a command flag in accordance with the instructions in A-AD-200-000/AG-000, Honours, Flags and Heritage Structure of the CF soon to become A-DH-200-000/AG-000; The Heritage Structure of the CAF, Chapter 13, Annex A.

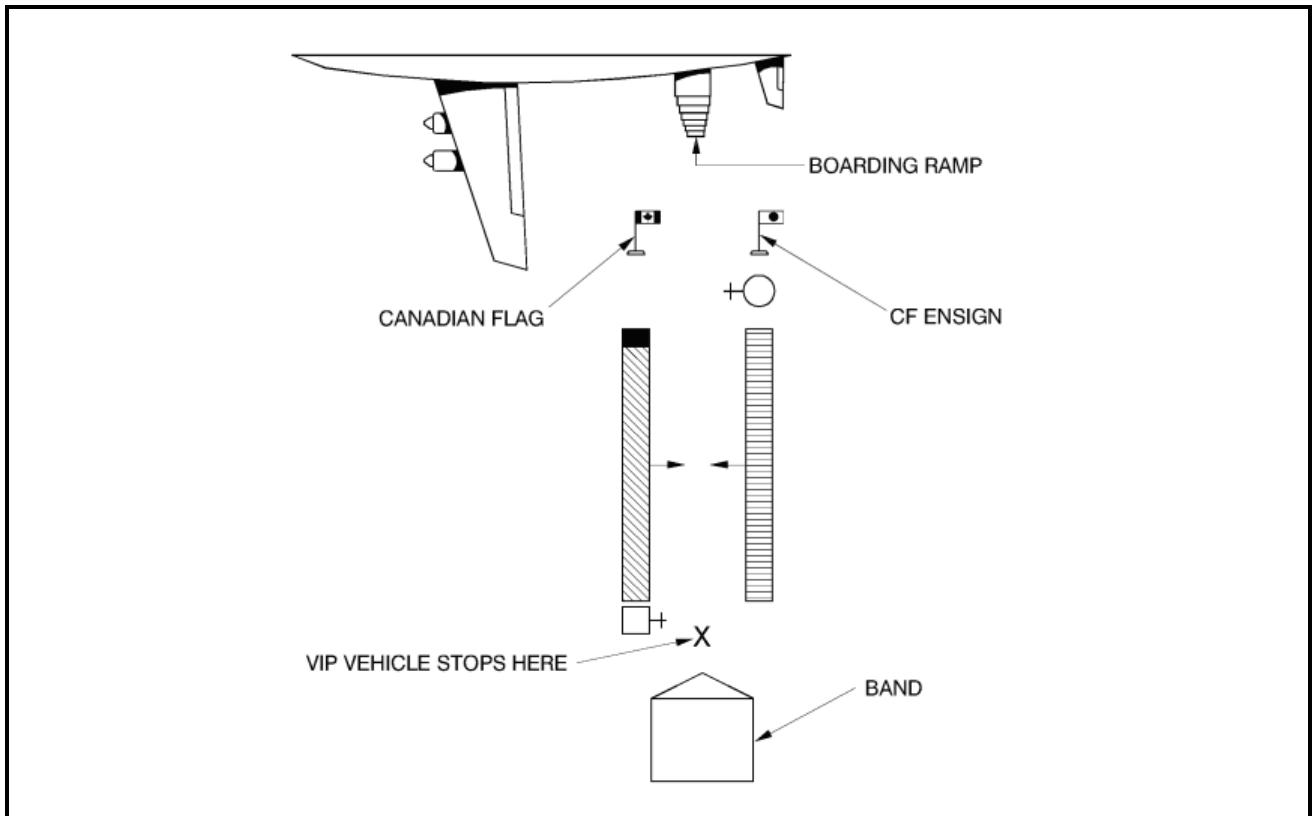

Figure 10-4- 1 Departure Guard

COMPLIMENTS

17. For a ceremonial arrival guard mounted to honour a number of personages, e.g., at an investiture, clear instructions must be given to the guard commander on the levels of compliments to be paid to the different arriving personages. That is, when the guard is to be ordered to stand at ease, at attention and, if armed, when arms are to be shouldered or presented (for swords, the carry, recover or salute).

18. For a personage entitled to full compliments on arrival or departure, when the vehicle carrying the personage comes to a stop, the guard commander shall bring the guard and band to attention and proceed as follows:

- a. **With Arms.** The guard commander shall order SHOULDER – ARMS and as the personage approaches to proceed without pause through the guard, GUARD, PRESENT – ARMS. The band shall softly play appropriate music. When the personage has passed through the guard, the guard commander shall order, GUARD, SHOULDER – ARMS.
 - b. **Without Arms.** After the guard and band has been ordered to attention, the band shall softly play appropriate music. As the personage proceeds through the ranks, the guard commander only shall salute. The salute shall be terminated then the personage has passed through the guard, and the band shall then cease playing.
19. The words of command for a ceremonial arrival guard lining an interior stairway or corridor shall only be loud enough to be heard by the guard. Pre-arranged signals may be used in lieu.

DISMISSING THE GUARD

20. After the personage or personages have cleared the area, the guard may be marched off and dismissed.
21. For safety reasons when a personage is departing by air, immediately after the aircraft door has been closed, the guard commander shall order FRONT RANK, THREE PACES FORWARD – MARCH; and GUARD, MOVE TO THE LEFT, RIGHT AND LEFT – TURN (turning away from the aircraft); and then march the guard and band off to the dismissal area.

CHAPTER 11

RELIGIOUS SERVICES AND FUNERALS

SECTION 1

RELIGIOUS SERVICES

REMEMBRANCE SERVICES

1. The procedures detailed below shall be followed in all circumstances without alteration.
2. The vigil consists of four corporals/privates (with both male and female representation if possible). Unless the service is specifically held to remember personnel from a single environment or unit, the four are customarily chosen from the three environments of the Canadian Armed Forces and from the Royal Canadian Mounted Police when practicable.
3. A vigil shall be mounted on the cenotaph/memorial as noted in Section 2, 15 minutes prior to the service, with the front of the cenotaph/memorial corresponding to the foot of the casket. The vigil shall remain on duty unrelieved until the senior dignitary has departed on completion of the ceremony. During their tour of duty, the vigil shall remain at rest on arms reversed. Accompanying the Vigil Party at the National War Memorial is a Nursing Officer.
4. The parade should be in position at the cenotaph/memorial 10 minutes prior to the ceremony and standing easy.
5. As the senior dignitary's vehicle approaches, the parade commander shall bring the parade to attention. If arms are being carried, the parade then shall be brought to the shoulder arms position.
6. When the senior dignitary is in position on the dais, the parade commander orders the appropriate compliments noted in A-AD-200-000/AG-000, The Honours, Flags and Heritage Structure of the CF soon to become A-DH-200-000/AG-000, The Heritage Structure of the CAF, Chapter 13. If the dignitary is a senior officer (colonel, lieutenant-colonel or major) or if arms are not carried, drill is in accordance with Chapter 9, Section 2, paragraphs 18 to 22.
7. The remembrance ceremony itself commences with the band playing "O Canada". The parade shall remove headdress prior to prayers of remembrance; headdress is replaced on completion of prayers (see Chapter 2, paragraph 23).
8. Buglers or trumpeters shall sound "Last Post" just prior to the commencement of the two-minute period of silence (normally 11:00 to 11:02 hrs). At those locations where a 21 gun salute is fired as an integral part of the Remembrance Day ceremony when requested by the Remembrance Day ceremony organizer, a single round will be fired at 11:00hrs to signal the start of the two minutes of silence. (see A-AD-200-000/AG-000, The Honours, Flags and Heritage Structure of the CF soon to become A-DH-200-000/AG-000; The Heritage Structure of the CAF, Chapter 13).
9. During the silence, no musical instrument shall be played, including bagpipes, as this detracts from the purpose of the event which is the quiet reflection on the service and sacrifice of the dead. Following the two-minute period of silence, "Rouse" shall be sounded. The lament may be incorporated either before the "Last Post" or after the "Rouse", or, if the parade commander so wishes, after the two minutes silence and before the "Rouse". The commencement of the 21 Gun Memorial salutes, if available, occurs immediately after the two minutes silence (at the start of the "Rouse" or lament). After the playing of "Rouse" or lament the reading of the "Act of Remembrance" may occur, after which the official wreaths shall be laid. During the laying of wreaths, the parade shall be in the stand at ease position.
10. The accompanying wreath bearers shall be one pace to the left rear of the dignitary, carrying the wreath in the left hand whenever possible. When the dignitary salutes or bows his head, the bearer shall salute.

11. On completion of the official wreath laying, the parade shall be brought to attention and the band shall play "God Save The Queen". The remembrance ceremony is then complete. It is at this time that the spectators may come forward to lay 'unofficial' wreaths.

12. The dignitaries may depart or move to a saluting dais. The parade will march past and be dismissed.

CHURCH PARADES IN CHURCHES

13. On arrival at the church, the parade is halted and the officers fall out. Under command of the warrant officers, the parade enters the church in single file, followed by the officers.

14. After the service, the officers shall file out of the church first, followed by the rank and file. The parade shall fall in as quickly as possible and move off to avoid traffic congestion.

15. Religious tenets, including those which are gender based, shall be respected (see Chapter 1, Section 2, paragraph 22). For Christian churches, headdress will be removed at the church entrance, and replaced at the exit. The advice of the officiating clergy will be sought and followed in each case.

CHURCH PARADES ELSEWHERE

16. If a church parade is to be held in a drill hall or similar area, the battalion shall be formed up normally, except that the chief warrant officer shall position company markers so that the whole of the battalion can be accommodated in the area. The commanding officer shall order the battalion to remove headdress and stand at ease before the chaplain proceeds with the service. On completion of the service, the commanding officer shall call the battalion to attention and order it to replace headdress before carrying on normally.

17. For a Drumhead Service:

- a. The parade shall form up on the parade ground with the band at the centre rear of the parade;
- b. On the command to form hollow square, the band marches to a position on the right flank, facing inwards (see Figure 11-1-1);
- c. When the band is in position, the drums are piled to form an altar under the command of the drum major in the same manner as for consecrating Colours (see Chapter 9, Section 4, paragraphs 11 to 14);
- d. The parade commander then orders REMOVE – HEADDRESS and the chaplain conducts the religious service; and
- e. Following the service, headdress is replaced, the drums are unplied and the parade dismissed.

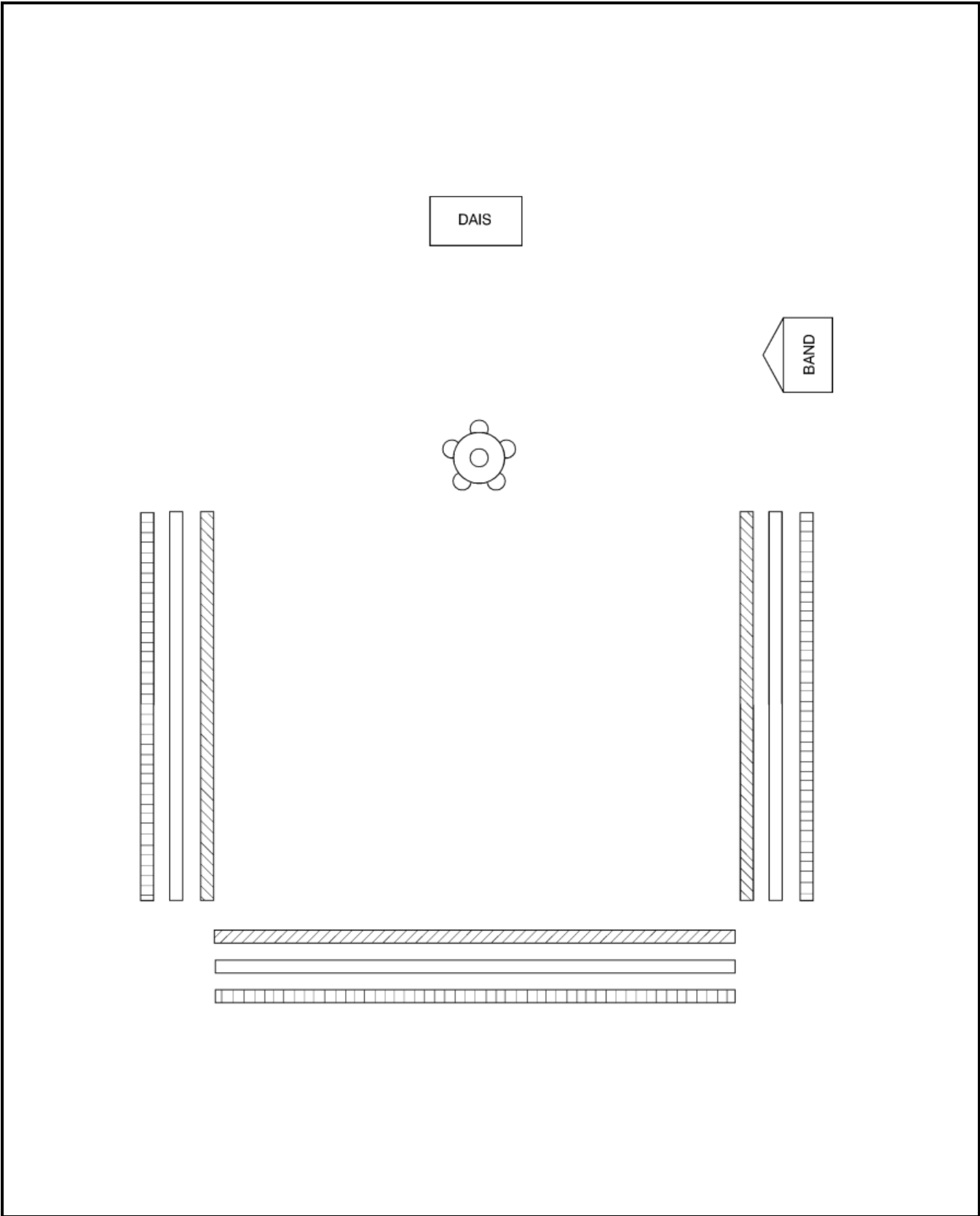

Figure 11-1-1 Drumhead Service

SECTION 2

FUNERALS

INTRODUCTION

1. There are three types of funerals: state (one officially sponsored by the government as a public expression of honour), military (one carried out by the military in accordance with this section) and civilian.

a. This section deals with the first two.

b. It is permissible to augment a civilian funeral by providing a bugler to sound the "Last Post" and the "Rouse", and band music. Remarks on mourning bands and headdress removal also apply, the guidelines being those of common courtesy.

2. All Canadian Armed Forces (CAF) personnel attending a state or military funeral in uniform shall wear either Full Dress, No. 1 or No. 1A Ceremonial order of dress; the order of dress shall be the same for all within any one component in the funeral party. In addition:

a. Mourning bands shall be worn during the ceremony by all officers and chief warrant officers. They shall be removed immediately after the burial services have been completed.

b. Headdress shall be removed at the beginning of the grave side service and replaced before the sounding of the "Last Post" and "Rouse". Headdress shall not be removed by the guard or band.

3. During a funeral, words of command should be subdued so as not to detract from the ceremony, but given loudly enough to ensure that necessary actions are taken. Similarly, when bands are repositioning themselves on parade, they shall do so with subdued verbal commands or visual signals and without drum beats. The music (Including pipers) shall cease playing prior to entering the cemetery grounds. (Single drum beats cadence)

4. All members of the guard shall bear arms. The escort normally should bear arms, but if this is not feasible, the escort may be unarmed except for colour escorts. Bayonets will not be fixed by the guard or escort, except the Colour escorts.

5. On specific request from the next of kin only, a firing party, formed from the guard, will fire volleys at military funerals (see Chapter 4, Section 2).

6. Officers attending funerals as mourners shall not draw swords. Officers wearing swords and commanding troops bearing arms shall draw swords, but will return swords prior to entering the place of burial. The bearers shall be military personnel

7. Flags flown on poles and masts shall be half-masted as noted in A-AD-200-000/AG-000, The Honours, Flags and Heritage Structure of the CF soon to become A-DH-200-000/AG-000; The Heritage Structure of the CAF.

8. The National Flag shall be used to drape the casket at the funeral ceremony unless the next of kin specifically requests that the CAF Ensign be used in lieu. No other flags shall be carried on parade (see A-AD-200-000/AG-000, The Honours, Flags and Heritage Structure of the CF soon to become A-DH-200-000/AG-000; The Heritage Structure of the CAF).

9. Colours carried in funeral processions shall be draped as noted in Chapter 8, Section 1, paragraph 9. They shall not be saluted while part of the funeral party and in attendance upon the casket, the honour being reserved for the deceased. Colours carried by units tasked with route lining shall follow the procedures detailed in Chapter 12, Section 1.

THE NEXT OF KIN'S WISHES

10. The expressed wishes of the next of kin will be respected at all funerals whenever possible.

11. Commonly, next of kin request more intimate funerals, either with smaller funeral parties or by leaving out the full sequence of a military funeral. For example, the next of kin may request military participation in the church service only, with limited representation at the grave site. In these cases, flags and accoutrements can be removed from the casket when most convenient.

12. If the exigencies of the service, such as a shortage of personnel, prevent the provision of all the elements of a military funeral desired by the next of kin, every effort should be made within local resources to ensure a military presence.

THE FUNERAL PROCESSION

13. The composition of a funeral party is detailed in Table 11-2-1 and illustrated in Figure 11-2-5.

14. The strength of funeral parties is detailed in Table 11-2-2. Funeral parties shall not exceed those detailed, although the next of kin may request less formality, for example, only a bearer party.

No.	Element	Detail
1	Escort	The escort shall lead the funeral procession. The strength of the escort is detailed in Table 11-2-2. The escort may carry Colours. The escort may be armed.
2	Guard	The strength of the guard is detailed in Table 11-2-2. The guard shall be armed. If a trumpeter/bugler is in attendance in lieu of a band, he shall march with the guard, as may a piper. The firing party shall be formed from the guard.
3	Band	The band, with drums muffled, shall commence playing the Funeral March from the church. The band shall cease playing when within 300 metres of a hospital or infirmary. The band (including pipers) shall cease playing prior to entering the cemetery grounds. (Single drum beats cadence).
4	Funeral Commander and Officiating Clergy	The funeral commander shall march in front of the officiating clergy.
5	Gun Carriage	The casket shall be borne on a gun carriage, if available. If not, a hearse shall be used.
5a	Gun Carriage Commander	If the carriage is a naval field gun carriage, the commander of its crew shall be on either flank, whichever is more convenient (for naval field gun carriage drill, see Chapter 12, Annex A). If the carriage is an artillery gun carriage, the detachment commander shall ride in the tractor with the driver.
6	Bearer Party	The strength and composition of the bearer party is detailed in Table 11-2-2. The bearers are the personnel who carry the casket (see Section 3). The commander of the bearer party shall ensure that the flag, headdress, etc., on the casket are properly arranged throughout the funeral. Headdress of the bearers Party? shall be removed when carrying the casket. The bearers shall be military personnel
7	Headdress Bearers	The headdress bearers shall carry the headdress of the members of the bearer party who are carrying the casket.
8	Honorary Pallbearers	Honorary pallbearers normally are selected from the same rank as that held by the deceased. The honorary pallbearers shall be either military personnel or civilians; they shall not be mixed. The strength of the honorary pallbearers is detailed in Table 11-2-2. The position of the pallbearers will be in order of seniority, alternating on either side of the casket; the senior being at the foot of the deceased on the right-hand side, the next senior in rank on the left-hand side, etc. (pallbearers were originally personnel who carried the pall, which was a cloth, usually of black, purple or white velvet, spread over a casket).

Table 11-2- 1 (Sheet 1 of 2) The Funeral Procession in Order of March

No.	Element	Detail
9	Insignia Bearer(s)	The orders, decorations and medals of the deceased may be carried on a cushion by the insignia bearer. If two or more insignia bearers are necessary, they shall both be either serving or retired members of the CAF. If an insignia bearer is retired, he shall wear uniform in accordance with QR&O 17.06(3). The insignia bearers are military members and normally are nominated by the family of the deceased.
		<p>NOTE</p> <p>It is acceptable custom to not employ insignia bearers. In this instance the orders, decorations and medals are left (secured) on the flag draping the casket.</p>
10	Chief Mourners	The chief mourners may walk or ride in the procession.
11	Queen's Representative	Her Majesty may be represented by a member of the Royal Family, Governor General or Lieutenant-Governor
12	Government Representative	
13	Military Mourners in Uniform	Military mourners in uniform shall position themselves in order of seniority
14	Mourners Not in Uniform	
15	Rear Detachment of the Escort	The strength of the rear detachment is detailed in Table 11-2-2.

Table 11-2-1 (Sheet 2 of 2) The Funeral Procession in Order of March

COMPOSITION OF FUNERAL PARTIES												
Serial	Deceased	Funeral Commander	Marching Elements									
			Escort		Guard		Bearer Party		Honorary Pallbearers	Rear Detachment		
			Strength	Commander	Strength	Commander	Strength	Commander		Strength	Commander	
(a)	(b)	(c)	(d)	(e)	(f)	(g)	(h)	(i)	(k)	(m)	(n)	
1	CDS	BGen or above	400	Col	50	Capt	8 CWOs	CWO	8	50	Capt	
2	BGen and above	Col	225	LCol	50	Capt	8 CWOs	CWO	8	25	Lt	
3	Maj to Col	Officer of equivalent rank	60	Maj	12	Sgt	8 WOs	MWO	8	25	Lt	
4	OCdt to Capt	SLt to Capt	40	Capt	12	Sgt	8 cpls to Sgts	WO	8	—	—	
5	WO to CWO	SLt to Capt	40	Lt	12	Sgt	8 cpls to Sgts	Sgt	8	—	—	
6	Sgt and below	SLt to Capt	20	Sgt	12	Sgt	8 Sgts or below	Sgt	—	—	—	

NOTES

1. When CWOs, MWOs or WOs are not available, the next lower rank shall be used.
2. The numbers shown in columns (d) and (m) are subject to the resources available to the unit conducting the funeral.
3. This table does not include mourners.
4. Whenever possible, a band and trumpeter/bugler shall participate in a military funeral. A piper may also participate. Trumpet and bagpipe banners are to be draped with black crepe tied in a bow. Drums are to muffled and draped with black material. Drum Major maces, less those for regiments of foot guards, are to have the head covered with a black bag.
5. The strength of the guard bears the same relationship to the rank of the deceased as does a guard of honour (see A-AD-200-000/AG-000, The Honours, Flags and Heritage Structure of the CF, Chapter 13). The guard for a deceased colonel and below is of the same strength as a ceremonial quarter guard, less two posts of double sentries, and is the strength required for a firing party.
6. A firing party shall be used only on the specific request of the next of kin and shall be formed from the guard.
7. The numbers shown in column (h) and (i) will depend on the size of the casket (either six or eight bearers may be used). When eight bearers are used, an additional two reserve bearers shall be tasked. The bearer party shall always included two headdress bearers.

YAPD2204

Table 11-2- 2 Composition of Funeral Parties

THE VIGIL

15. The body of a deceased dignitary for whom a state funeral is ordered usually lies in state in the Centre Block of the Parliament Buildings or in the Provincial Legislative Assembly building. The period of time during which the deceased will lie in state is directed by the government minister responsible for the funeral arrangements.

16. The guarding of the casket during the lying in state is called the vigil. The privilege of guarding the casket of a deceased serving or former Governor General, or other former or serving vice-regal representative, normally is accorded to officers of the CAF and the Royal Canadian Mounted Police (RCMP). Similarly, and unless ordered to the contrary, warrant officers and sergeants of the CAF and non-commissioned officers of the RCMP are accorded the privilege of guarding the casket of a deceased dignitary who is of other than vice-regal or former vice-regal status. (The protective staffs of the Senate and the House of Commons also usually participate in a vigil in Parliament for non-military personages. Military and protective staff members shall not be intermingled during a vigil shift.)

17. The vigil shall be maintained on a 24-hour basis. However, the minister responsible for the funeral arrangements may wish to shorten or otherwise restrict the periods of the vigil.

18. The period of vigil for each watch shall be 30 minutes.

19. Vigils mounted on cenotaphs for remembrance services (Section 1) correspond to those detailed in this article, except:

- a. the privilege of guarding a cenotaph is accorded to corporals/privates; and
- b. since the period of vigil is short, there is only one watch with no relief.

20. Six sentinels are always on duty (see Figure 11-2-1). Each watch consists of:

- a. the commander (a senior officer or warrant officer, see paragraph 16);
- b. the senior on the right of the casket at the foot (Number 1);
- c. the next senior on the left of the casket at the foot (Number 2);
- d. the next senior on the right of the casket at the head (Number 3);
- e. the next senior on the left of the casket at the head (Number 4); and
- f. the sentinel-in-waiting (officer-in-waiting) (Number 5).

21. The commander of each watch positions himself facing the foot of the casket, where he can see all the sentinels on duty. He shall stand at attention (if an officer, he does not draw his sword).

22. Numbers 1 to 4 shall face outwards, obliquely, resting on their arms reversed.

23. The sentinel-in-waiting positions himself where he can see the commander. He shall stand at ease (officers do not draw their sword).

24. The sentinel-in-waiting of the next relief shall be in the waiting room, fully dressed and available for duty if called.

25. The following is the procedure for posting the vigil:

- a. The vigil shall be inspected in the waiting room by the commander;

- b. They form up in single rank in the following order: 2, 4, 1, 3 and 5 (see Figure 11-2-2);
- c. Number 1, 2, 3 and 4 draw swords (officers only);
- d. They march in single file, in slow time, to the lying-in-state chamber, followed by the commander;
- e. On entering the chamber, Number 2 and Number 4 pass the head of the casket and wheel right. Number 1 and Number 3 wheel right and pass along the near side of the casket;
- f. It is essential that Number 1 and Number 2 go forward in line, as do Number 3 and Number 4, who shall step short. They mark time on arriving at their stations;
- g. The commander quietly orders HALT;
- h. While Numbers 1 to 4 are taking up their stations, Number 5 takes up his station, halts independently and stands at ease;
- i. After halting on their stations, Numbers 1 to 4 observe a standard pause and turn outwards;
- j. The commander quietly orders PRESENT – ARMS and after a standard pause, REST ON YOUR ARMS – REVERSED; and
- k. The commander remains at attention.

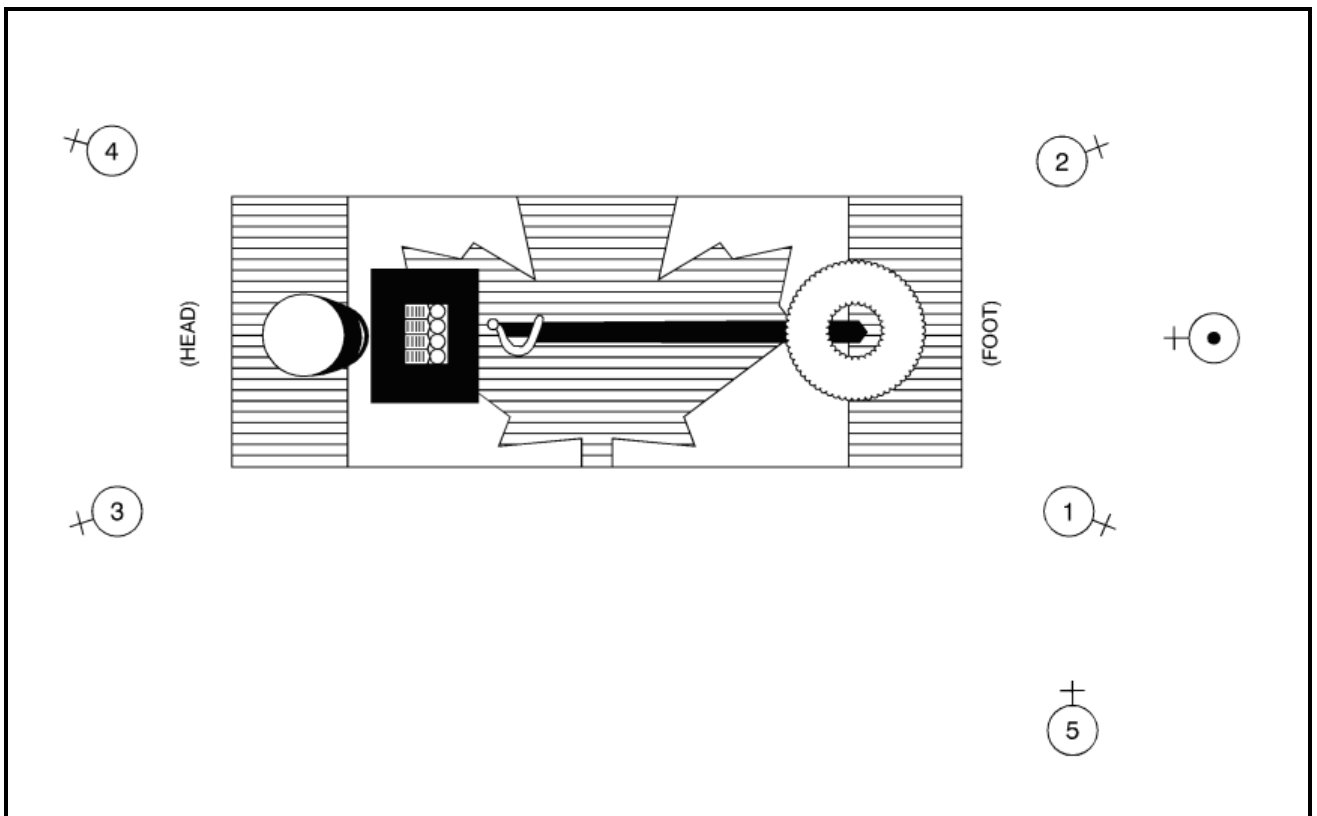

Figure 11-2-1 The Vigil

26. The following is the procedure for relieving the vigil:
- a. The relief vigil shall be inspected, form up, (officers draw swords) and slow march as noted in paragraph 25;
 - b. They enter the chamber as noted above. After arriving at a position one pace to the right of and facing the same direction as the old vigil, they mark time (see Figure 11-2-3);
 - c. The commander orders HALT. The commander then gives a double tap on the ground with the scabbard, or a tap on the handguard of the rifle, as the signal for sentinels to change;
 - d. The old vigil raise their heads, observe a standard pause, present arms (bring the sword to the recover), observe another standard pause, shoulder arms (return sword to the carry), observe another standard pause and step off together in slow time and march to the waiting room in the order: 3, 1, 4, 2 and 5;
 - e. On the third pace of the old vigil, the new vigil take a pace to the left, observe a standard pause, present arms (bring the sword to the recover), observe another standard pause and rest on their arms reversed; and
 - f. After No. 1 of the old vigil has passed through the exit, the old commander shall salute and retire, his place being taken by the new commander.
27. All movements during reliefs are to be carried out in a slow dignified manner and not in ordinary drill in quick time.

28. Should a sentinel require a relief to complete the vigil, he shall raise his head. On this signal, the sentinel-in-waiting shall immediately come to attention and shoulder arms (draw his sword) and take the place of the sentinel who has signalled using the same procedures as detailed above. The sentinel relieved shall retire immediately to the waiting room and the sentinel-in-waiting of the next relief shall take over as sentinel-in-waiting in the chamber.

PROCEDURE FOR THE DEPARTURE OF THE CASKET

29. The last relief is to ensure that there is sufficient room for the bearer party to move into position. The vigil commander must be positioned so that visual contact can be made with the funeral commander and the bearer party.

30. The funeral commander and the officiating clergy, accompanied by the members of the family, enter and move to pre-designated positions. Then, on a signal from the funeral commander to the bearer party (the signal can be relayed through the vigil commander if sight lines do not permit), the bearer party marches in slow time to the casket and place the casket on their shoulders.

31. The vigil commander then quietly orders PRESENT – ARMS. All sentinels will come to the recover position and then salute, remaining in position until the casket has departed. The sentinel-in-waiting gives a hand salute as does the commander if he is an officer. In the case of non-commissioned members, the commander will shoulder arms and then order PRESENT – ARMS. The four sentinels at the casket will execute the movement, the commander will salute at the shoulder on the last movement of the present arms and the sentinel-in-waiting will stand fast.

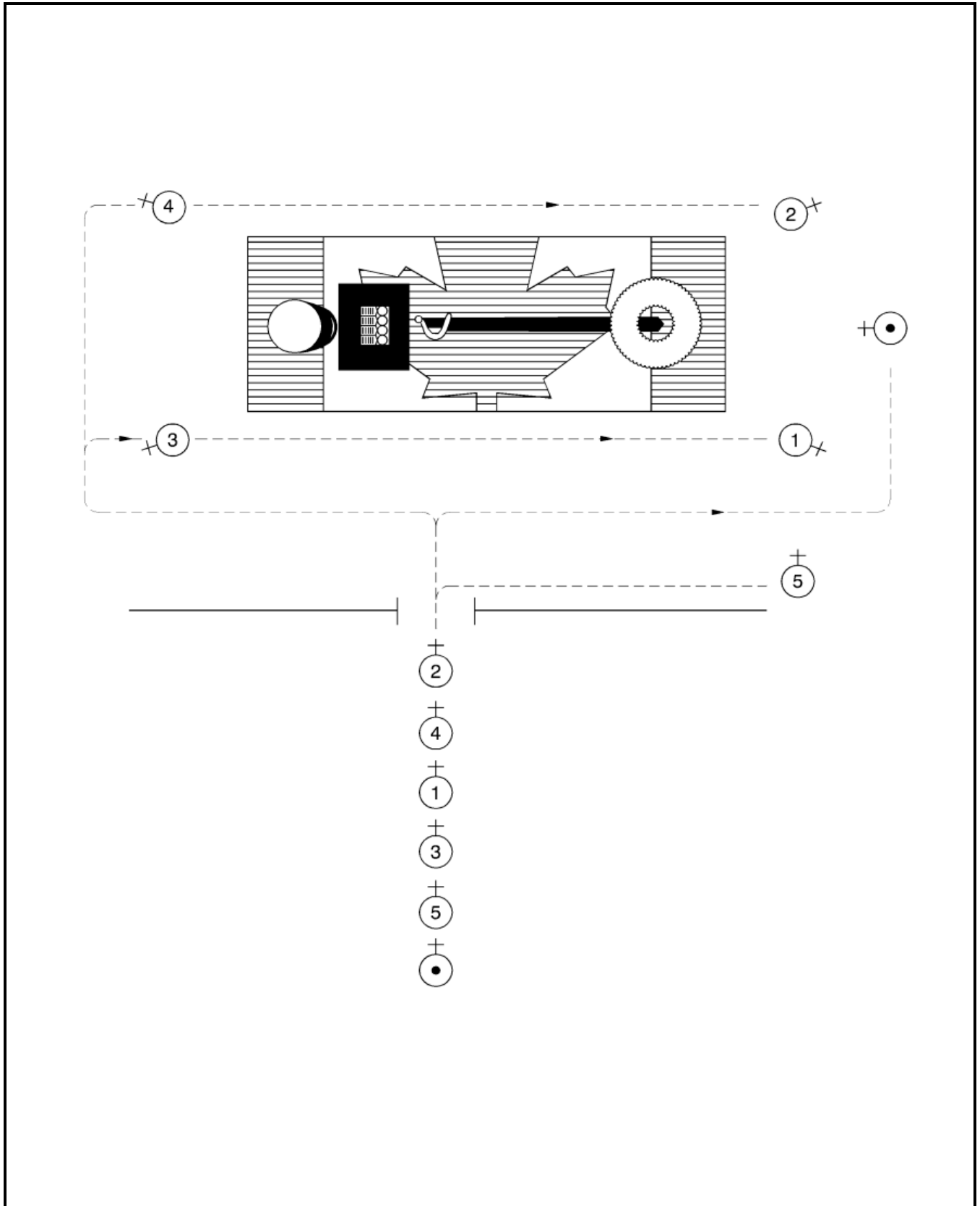

Figure 11-2- 2 Posting the Vigil

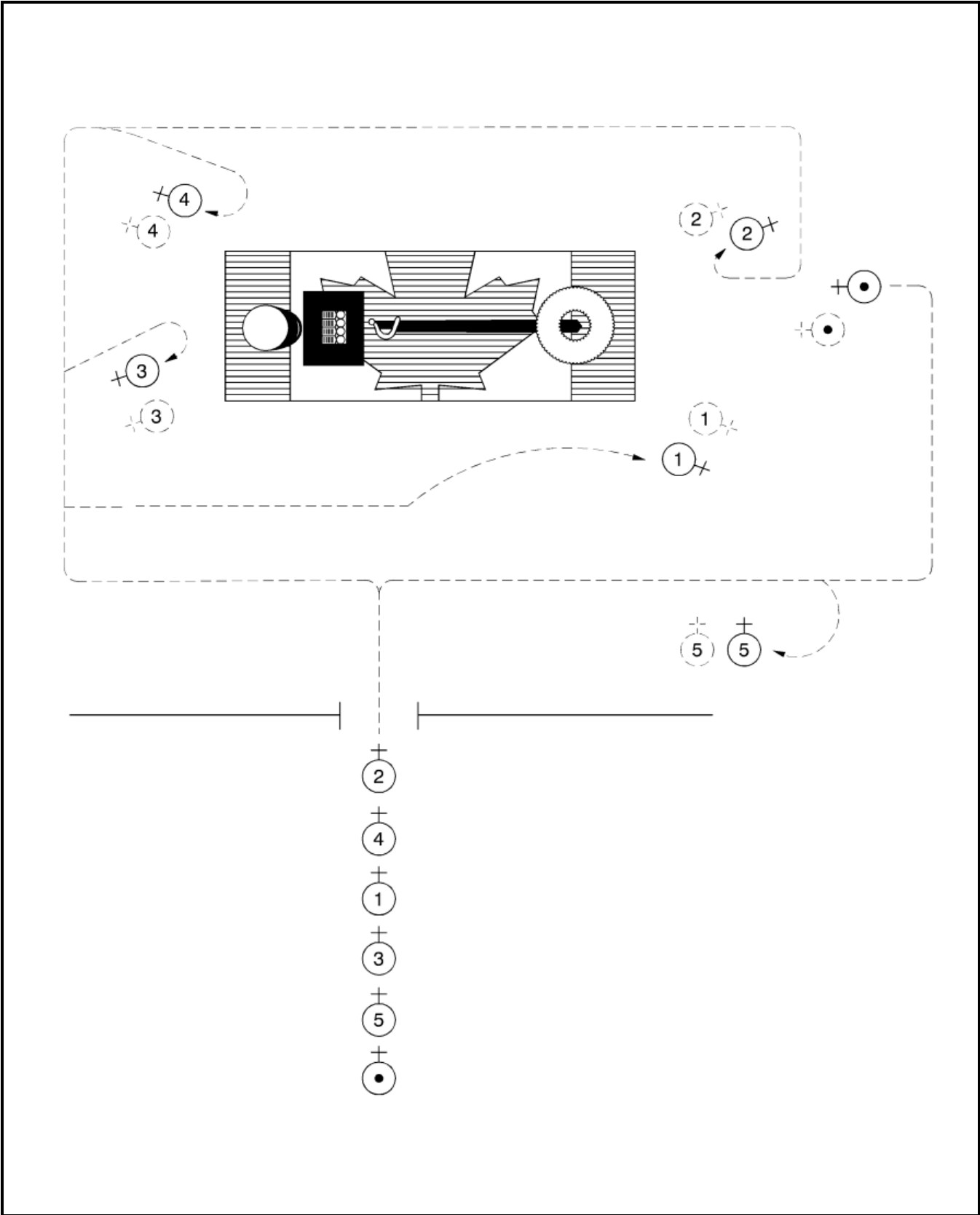

Figure 11-2- 3 Relieving the Vigil

THE CHURCH SERVICE

32. The customs of the particular religion shall be respected in all cases. For example, Jewish deceased are normally buried within 24 hours of their death and the caskets of Christian deceased are positioned differently for clergy and for lay people. The advice of the officiating clergy should be sought and followed, especially for the services in the church and at the graveside.

33. For a state funeral, if the deceased has been lying in state in the church, the vigil shall be dismantled one-half hour prior to the commencement of the church service. If the deceased has been lying in state in a place other than the church, he shall be escorted to the church by the procession as detailed in paragraphs 38 to 46.

34. In a military funeral, where the deceased will be placed in the church the same day as the service, the following procedure will take place on the arrival of the hearse at the church:

- a. The guard will be drawn up in two ranks, in open order, with arms at the shoulder, centred and facing the church door. The guard commander shall be posted three paces in rear and centre of the guard.
- b. The bearer party and its commander shall form in two ranks facing inwards, ranks being apart sufficiently enough to permit the hearse to drive through. As the deceased is removed from the hearse by the bearer party, the National Flag will be unrolled over the casket and the headdress and sword/belt-bayonet will be secured.
- c. As the deceased is being removed from the hearse, the guard commander shall order PRESENT – ARMS, and this position shall be maintained until the bearer party has entered the church. The guard commander will then order SHOULDER – ARMS and ORDER – ARMS, and the guard moved to a suitable place until it is required to re-form for the procession following the service.
- d. The bearer party, lead by the chaplain, shall proceed into the church, filing between the honorary pallbearers who had previously formed into two ranks, facing inwards, at the entrance to the church. The casket will be oriented as noted in Figure 11-2-4. The honorary pallbearers will follow the casket into the church and proceed to their pews.
- e. The bearer party, after entering the chancel, will lay the casket on the church carrier, and the insignia bearer will lay the medals on the casket. Under the command of its commander, the bearer party and the insignia bearer will proceed to the pews allocated for them.

35. When a funeral service is held for multiple casualties, the caskets may be arranged in the church prior to the service.

36. The positions of those attending the church service are indicated in Figure 11-2-4.

37. On the completion of the service, the officiating chaplain shall lead the way out of the church, followed in order by the:

- a. honorary pallbearers;
- b. casket and bearer party;
- c. insignia bearer;
- d. next of kin;
- e. relatives; and
- f. other mourners.

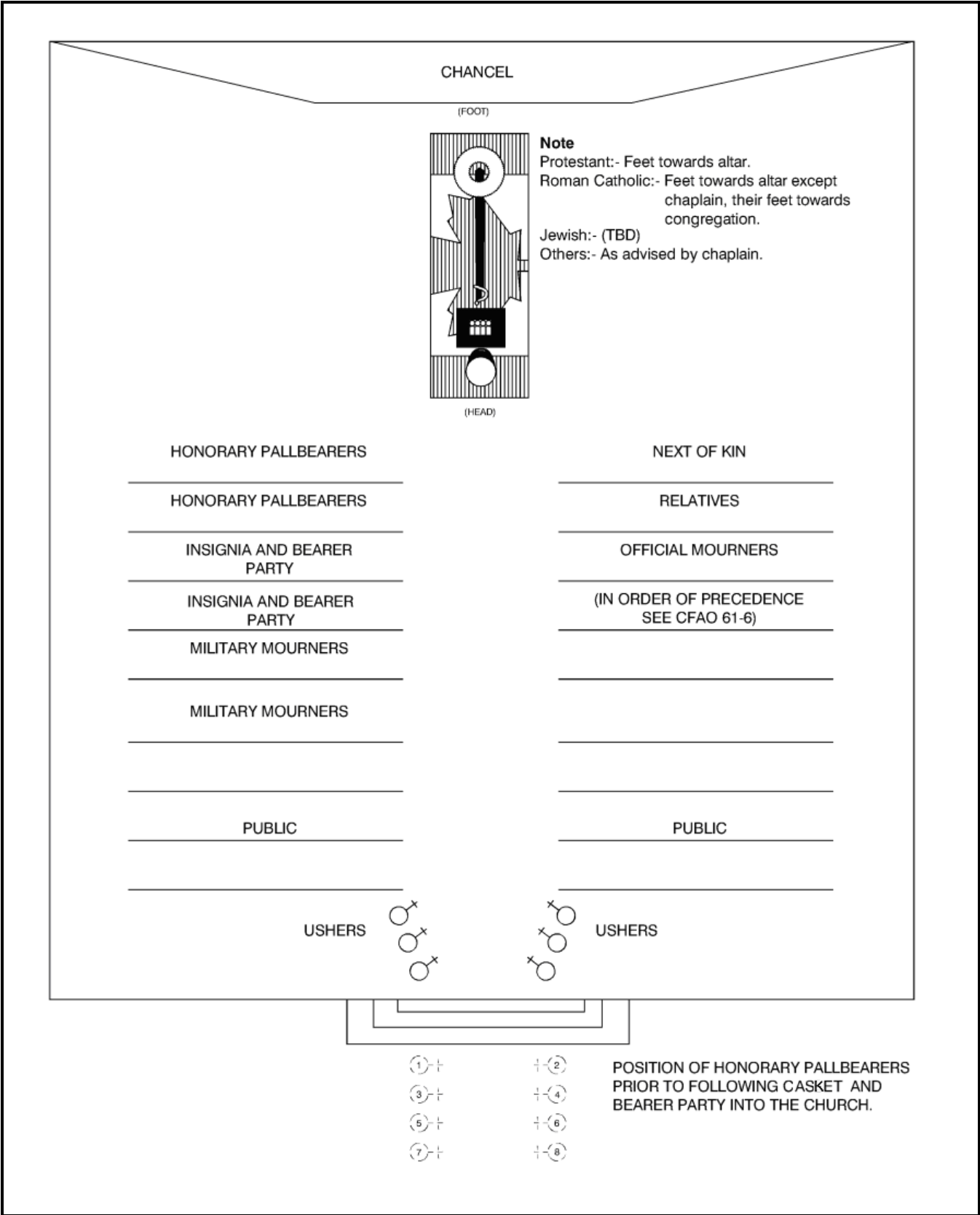

Figure 11-2- 4 The Church Seating Plan.

PROCESSION

38. While the funeral service is being conducted, the procession except for the guard (see paragraph 41) shall form up outside the church, as detailed in Figure 11-2-5.

39. Order of March. The unit of the deceased takes precedence over other units irrespective of seniority. Otherwise, units are to march in the reverse order to that usually followed, i.e. the senior unit and the senior rank marches nearest the casket (see Figure 11-2-5).

40. On completion of the funeral service, the chaplain shall descend from the chancel and proceed to the rear of the pews occupied by the honorary pallbearers. The commander of the bearer party, on seeing the chaplain descend from the chancel, shall lead the bearer party and the insignia bearer into the chancel, where each member shall halt quietly in the correct position. The insignia bearer shall remove the medals from the casket and adopt a position in rear of the commander. As the bearer party enters the chancel, the honorary pallbearers shall leave their pews and form in file behind the chaplain. The bearer party may have to turn the casket, and space for this should be left available. The bearer party shall raise the casket to their shoulders (see also Section 3, paragraphs 1 to 6), and on the commander's orders, SLOW – MARCH, the procession, lead by the chaplain, shall file out of the church to the gun carriage or hearse.

41. The guard shall be formed facing the entrance to the church and behind the gun carriage or hearse (leaving sufficient room for the bearer party and casket to pass between the guard and the church entrance), as detailed in paragraph 34a above. As the casket appears at the entrance of the church, the guard commander shall order PRESENT – ARMS. At this time all officers and personnel not under command shall salute. The guard commander orders SHOULDER – ARMS when the casket is secured on the gun carriage or placed in the hearse. The guard commander then marches the guard to its position in the procession in quick time.

42. After the guard commander has halted the guard in its position in the procession (remaining in the shoulder arms position), and after having ascertained that the whole procession is in position and prepared to move off, the parade commander shall give the following orders:

- a. REVERSE – ARMS; and
- b. PROCESSION, BY THE RIGHT (LEFT), SLOW – MARCH. The band shall commence playing the “Dead March” and if the deceased is entitled to a gun salute (see A-AD-200-000/AG-000, The Honours, Flags and Heritage Structure of the CF soon to become A-DH-200-000/AG-000; The Heritage Structure of the CAF, Chapter 13, minute guns shall commence firing.

43. The distance to be marched in slow time shall be at the discretion of the funeral commander. However, in urban centres a minimum distance of one-third kilometre shall be marched in slow time. If the distance to be marched requires it, the parade commander may either:

- a. after the minimum distance, order FUNERAL PACE, followed by ATTEN – TION as the cemetery is approached; or
- b. more commonly, order CHANGE TO QUICK TIME, QUICK – MARCH after the minimum distance from the church has been covered.

44. In rare cases, such as State funerals with long parade routes, and when a band is present, the funeral commander may also previously order a quicker cadence for slow time in parade instructions (normally 80 paces per minute) to assist marching personnel to maintain balance and natural rhythm over the long route. The band or bands must be carefully placed to ensure clear tempo to guide everyone simultaneously.

45. If the distance to the place of the burial is too great to march, the procession shall be halted after at least the minimum distance to embus for the cemetery or, if the next of kin so requests, there shall be no marching procession.

LEGEND

DISTANCES IN PACES \longleftrightarrow

NOTE

The funeral commander may march in front of the officiating clergy

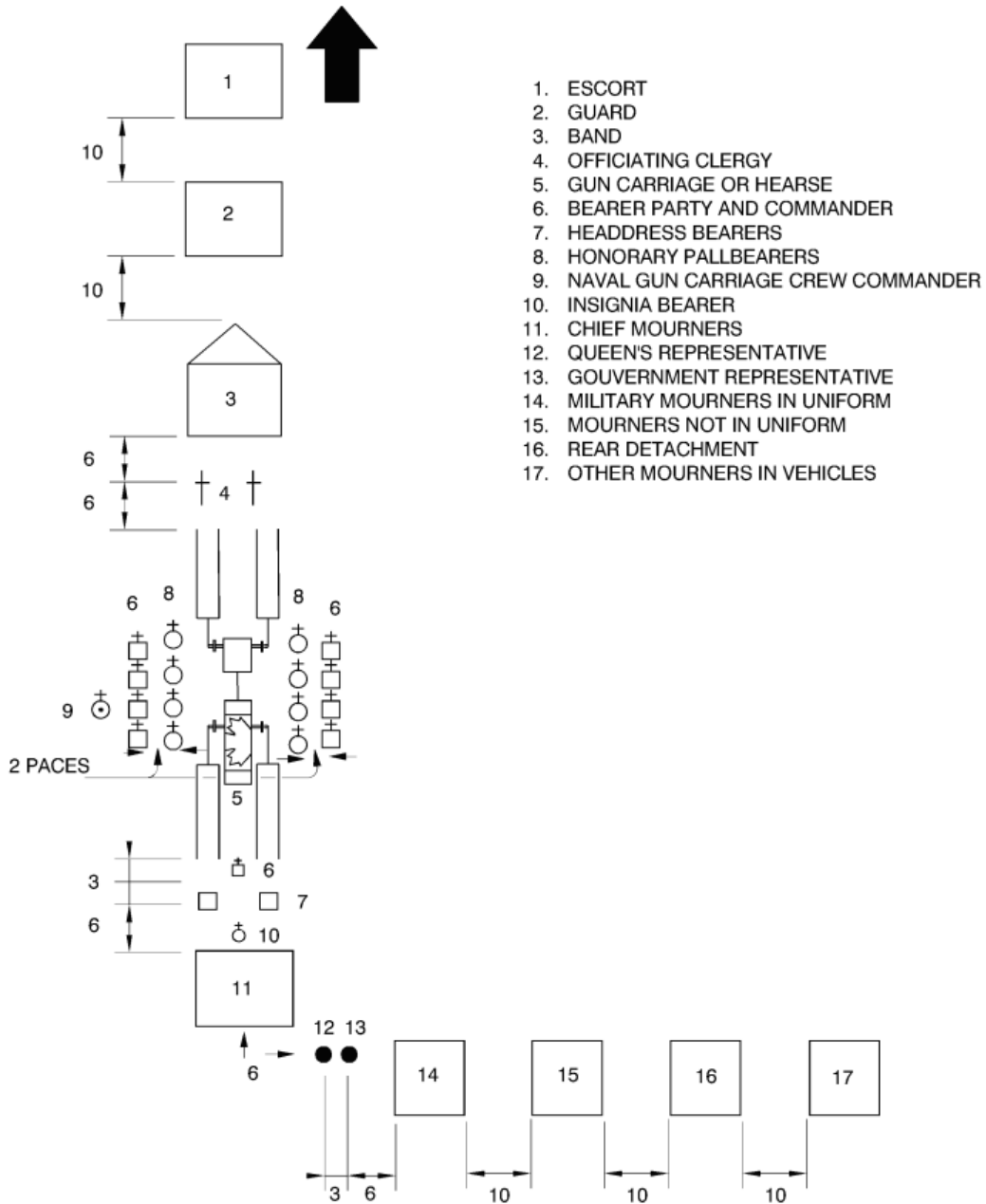

Figure 11-2- 5 Procession

THE MOVE TO THE GRAVESIDE

46. The route may be lined for funerals of senior officers and above. Except for state funerals, the escort shall be used for this purpose at the end of the route and the lining performed such that it ends at a convenient point near the graveside. The distance to be lined shall be in accordance with direction given by the parade commander. After considering the size of the cemetery and the location of the gravesite, he may direct that the route be lined:

- a. from the point where the cortege is to be met by the officiating clergy to the grave; or
- b. from the entrance of the cemetery to the grave; or
- c. for the normal frontage of the escort, in two ranks.

47. For state funerals, additional troops may be provided to line the route as detailed in Chapter 12, Section 1. If rifles are carried, bayonets shall not be fixed.

48. When the procession is at a convenient distance from the gates of the cemetery, or the point where the cortege is to be met by the officiating chaplain if he did not march in the procession, the officer commanding the funeral procession shall give the command ATTEN – TION; or PROCESSION, CHANGE TO SLOW TIME, SLOW – MARCH, as applicable.

49. The band shall play the "Dead March", ceasing to play when the head of the procession approaches the gates of the cemetery. The band shall not play inside the cemetery, except for a hymn during the service at the graveside.

50. When the head of the procession reaches the point from which the route will be lined, the escort commander shall give the command ESCORT, TO A __ PACE INTERVAL, IN TWO SINGLE FILES, LINE – ROUTE. The left file of the escort shall line the left side of the route and the right file shall line the right side of the route as detailed in Table 12-1-1. The leading half of the centre file shall wheel left and follow the left file, while the rear half wheels right and follows the right file. If the escort is armed, as each pair completes its about turn it shall, together, present arms and, if trained in ceremonial rifle drill, rest on its arms reversed.

51. The casket, feet foremost, accompanied by the honorary pallbearers, the bearer party, etc. is to be carried or transported, in slow time, through the two ranks formed by the escort.

52. The cortege, under command of the funeral commander, shall proceed to the graveside. Guard and band shall wheel independently and halt on predetermined positions on commands given by the guard commander and drum major. The casket, accompanied by the honorary pallbearers, the bearer party and the remainder of the procession, will continue to the graveside.

53. If, for reason of distance, it is necessary to provide transportation for the funeral procession, the whole procession is to disembark just outside or within the cemetery. The lining of the route by the escort will be adjusted accordingly. The funeral commander shall be responsible for the acquisition of transport for the escort, guard and band, and possibly for the chief mourners. Transportation arrangements shall ensure that the escort proceeds to the gates of the cemetery, or the point where the procession is to be met by the officiating chaplain, by a route quicker than that taken by the rest of the cortege, so that they are in position and lining the route when the remainder arrives.

ARRIVAL AT THE GRAVESIDE

54. On arrival at the graveside, the guard, band and officiating chaplain take up their positions (see Figure 11-2-6).

55. The gun carriage or hearse halts and the bearer party removes the casket. The guard present arms, and military personnel not under command salute.

56. The casket then is placed on stretchers over the grave.

57. After the casket has been placed on the stretchers, the guard shall be ordered to rest on their arms reversed if trained in ceremonial arms drill, or to shoulder and order arms. The bearer party, on its commander's commands, OUTWARDS – TURN, and QUICK – MARCH, move off by the foot of the grave to the right flank of the guard (see Figure 11-2-6). The headdress bearers return the headdress to each member of the bearer party.

58. The insignia bearer places the cushion with medals on the casket. He then joins the chief mourners or military mourners.

59. The chief mourners and honorary pallbearers take up their positions on arrival, followed by the military and civilian mourners.

60. The rear detachment take up their position immediately in rear of the guard.

61. When all the parties are in position at the graveside, the parade commander shall give the order PARADE, STAND AT – EASE. The officiating chaplain then shall step forward to commence the service.

GRAVESIDE SERVICE

62. The cautionary note in paragraph 32 on observing religious customs shall be followed.

63. As the officiating chaplain steps forward, the funeral commander orders PARADE, REMOVE – HEADRESS. All military personnel, except the guard and band, shall remove headdress.

64. On the completion of the service, the officiating chaplain shall step back. This is the signal for:

- a. the parade commander to order PARADE REPLACE – HEADRESS;
- b. the guard to present arms; and
- c. the bugler to sound "Last Post", observe a 10-second pause and then sound "Rouse".
- d. The "Lament" is not a required part of these ceremonies; it may be played either before or after The Last Post/Rouse sequence, but not between the two.

65. All officers and those non-commissioned members not under command shall maintain the salute from the first note of the "Last Post" to the last note of the "Rouse".

66. On completion of "Rouse", the guard shall be ordered to SHOULDER – ARMS.

67. Following the service, those present should pay their respects.

68. If a gun salute (not to be confused with minute guns) or rifle volleys (if no guns are available or for those not entitled to a gun salute, see A-AD-200-000/AG-000, The Honours, Flags and Heritage Structure of the CF soon to become A-DH-200-000/AG-000; The Heritage Structure of the CAF, Chapter 13) are to be fired on the specific request of the next of kin:

- a. for rifle volleys, the guard commander shall order the three volleys (see Chapter 4) before the present arms noted in paragraph 64.b.; or
- b. for gun salutes, the guns shall commence firing to normal salute timings as the casket is lowered into the ground.

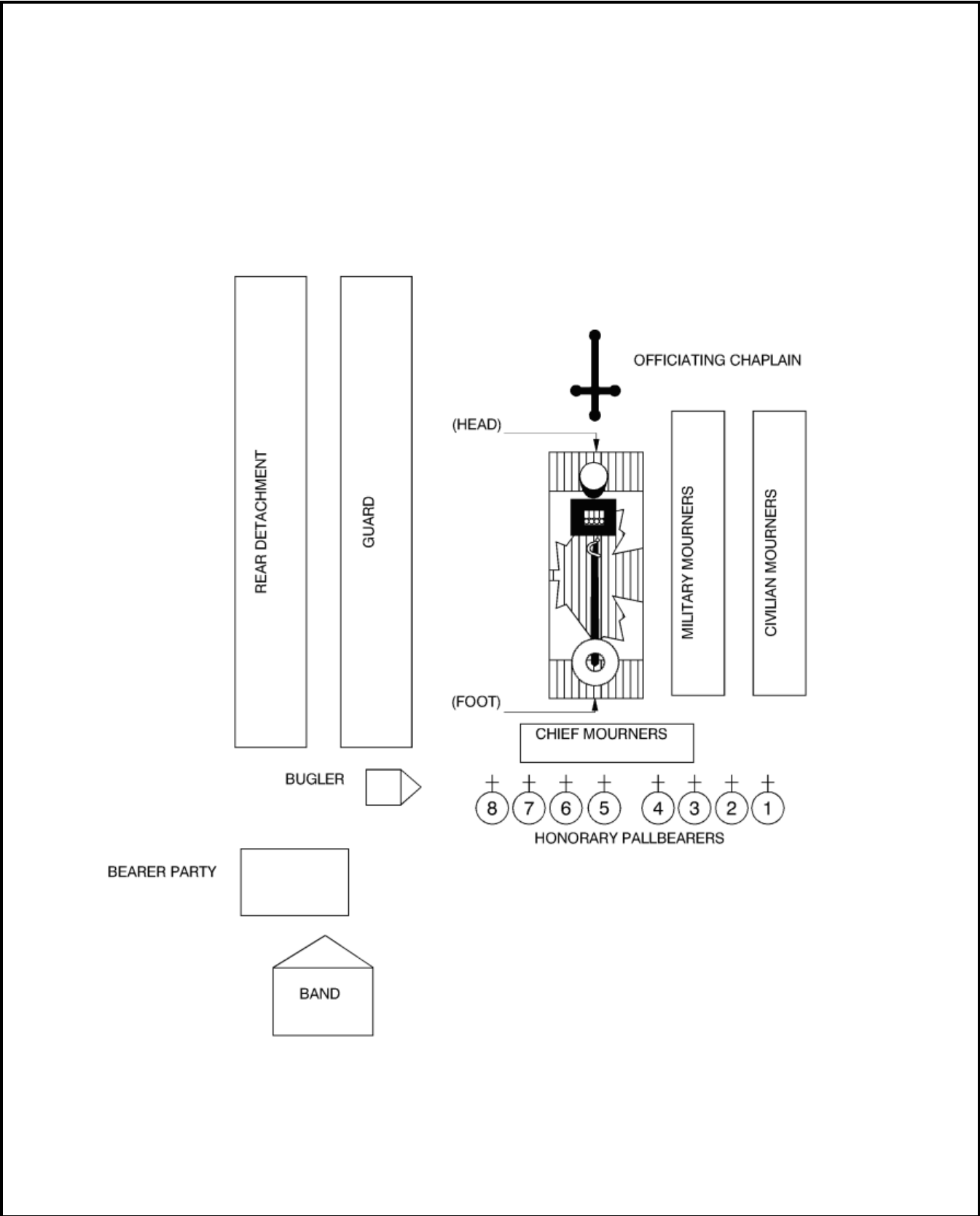

Figure 11-2- 6 Suggested Positions of Funeral Party at Gravesite

CONCLUSION

69. After the burial, flags shall be full-masted. Mourning bands shall be removed and Colours undraped to signify the end of military mourning on return to barracks or post burial reception.

70. The commander of the bearer party shall remain at the cemetery to collect the flag, medals, sword and headdress after the mourners have departed and the official photographs have been taken.

71. Officers senior to the officer commanding the funeral procession shall not rejoin the procession after the service at the graveside.

72. The bearer party and its supporting members shall fall in with the rear detachment, and the officer commanding the procession shall order the band and the various parties to march off independently and form in line outside the cemetery in the following order: band, escort, guard and rear detachment.

73. The procession then shall be marched off in quick time under the command of the parade commander. When it is well clear of the cemetery, the band shall play normal martial music.

74. If the various funeral sections have been transported to the cemetery, they are to be ordered by the funeral commander to march off independently to their vehicles from the graveside, under orders of their respective commanders. The various parties shall be dismissed independently on returning to their units.

CREMATION

75. When the remains are to be cremated, the procession proceeds directly to the crematorium.

76. At the crematorium, the burial service will be conducted in the normal manner. Prior arrangements will be made for the positioning of the guard outside the chapel and the bugler either inside or outside the chapel.

77. The ashes, flag and accoutrements will be collected from the crematorium staff at an appropriate time following the ceremony.

78. The urn is not normally displayed at any subsequent memorial service. Prior to a memorial service, a folded flag and accoutrements may be arranged for display on a table in front of the chancel.

79. The ashes may be buried or deposited in a cemetery, or scattered in accordance with the wishes of the next of kin.

SECTION 3

INSTRUCTIONS FOR THE BEARER PARTY, HONORARY PALLBEARERS AND INSIGNIA BEARERS

THE BEARER PARTY

1. Bearers should be the same height at the shoulder to facilitate carrying the casket on the shoulders. If this is not possible, the taller persons should be at the deceased members head. The bearer party composition is as detailed in Section 2, Table 11-2-2. The two reserve bearers may be employed to help lift and push at the rear of the casket when negotiating steps or stairs. When moving up and down stairways it may be necessary to reverse the order of bearers to maintain the casket level.
2. The headdress bearers follow two paces behind the bearer party commander when on the march. The reserve bearers, if designated, follow two paces behind the headdress bearers. The insignia bearer(s) follow two paces behind the reserve bearers (see also Table 11-2-1 and Figure 11-2-5).
3. The casket is always carried foot end foremost, except while manoeuvring to remove it from the gun carriage or hearse or place it on the grave stretchers.
4. When the casket is removed from a gun carriage, it shall be carried on the shoulders of the bearer party. When it is removed from a hearse, the casket may be carried on the shoulders of the bearer party or by its handles, depending on the bearer party's experience.
5. Words of command to the bearer party shall be given in a low voice, audible only to the bearer party. The cautionary word of command is always BEARER PARTY.
6. The bearer party and the bearer party commander shall not wear headdress when carrying the casket.

PROCEDURE TO MOVE THE CASKET FROM THE CHURCH OR CHAPEL TO THE GRAVESITE

7. When ordered, the bearer party are to step off and without ceremony, occupy their position alongside the casket and then turn inwards. The bearer party commander is to be two paces to the rear.
8. **Lifting and Carrying the Casket**
 - a. On the command PREPARE TO LIFT, given by the commander of the bearer party, the bearers are to place both hands, fingers together, under the casket, with the thumbs running vertically up the side, shoulder width apart, ensuring that the National Flag is between the hands and the casket (Figure 11-3-1);
 - b. On the command LIFT, the bearers are to take the weight by straightening the back, keeping their arms at their fullest extent and allowing the casket to clear the trestles (Figure 11-3-2);
 - c. On the command PREPARE TO RAISE – RAISE, the bearers are to raise the casket slowly, ensuring that it remains level, until the hands come into line with the shoulders (Figure 11-3-3);
 - d. On the command OUTWARDS, the hand nearest the foot end is to be rotated outwards, so that the thumb is underneath and the fingers together running vertically up the side (Figure 11-3-3);
 - e. On the command TURN, the bearers are to turn and face the foot end of the casket, at the same time placing the casket well onto the shoulders, the inside arm passing beneath the casket, so that the hand is able to rest firmly on the outside shoulder of the bearer's opposite number. The outside arm is to be bent at the elbow, the hand being positioned as close to the face as possible (Figure 11-3-4);
 - f. On the command TURNING, SLOW – MARCH, the bearer party are to execute a turn of 180 degrees to the right or far enough to face the required exit. In order to not disturb the casket whilst turning, the foot end bearers are to side-step a pace to the required direction then bring their feet together. The head end bearers are to side-step a pace to the opposite direction then bring their feet together. The centre bearers

are to side-step on the spot to the required direction. All bearers are to side-step simultaneously until facing the required exit;

- g. On the command **STAND STILL** they are to halt with their feet together. These movements are very difficult and must be carried out slowly;
- h. On the command **SLOW – MARCH**, the bearer party step off with the inside foot leading. The commander may keep step by saying very softly **INSIDE; OUTSIDE;** and
- i. The commander should remain two paces from the head end and follow the casket.

8A. Whenever the casket of a deceased member of the Canadian Armed Forces is being maneuvered up or down steps the utmost care must be taken. When a couple of steps or less are being navigated and the width of the tread of the steps is sufficient for the Bearer Party to remain in the forward movement position then the steps can be maneuvered slowly in that position. However, should the riser of the steps be high, the weather inclement, the casket heavy, or there is any doubt at all in the mind of the Bearer Party commander of the party's ability to safely maneuver the stairs then the following procedure should be used:

- a. The bearer party commander shall give the command **HALT, INWARD TURN, PREPARE TO LOWER – LOWER**, and then commence the maneuvering of the steps.
- b. On the command **HALT, INWARD TURN, PREPARE TO LOWER – LOWER**, the procedure outlined in Section 3 paragraph 9 shall be followed.
- c. The bearer party commander shall give the command **STEP**. On the command **STEP** the bearers close to the steps will take one step up or down the steps making sure to move their foot far enough in on the tread to ensure that there will be room for their second foot. They will then move their other foot up (or down) the step at the same time. At the same time the other bearers will take one step towards the step. On each consecutive command **STEP** another step will be taken until all the steps have been maneuvered.
- d. The bearer party commander will maintain his position behind the casket and ensure that the consecutive **STEP** commands are given slowly and that the casket is at all times level and in the control of the bearers. Should the casket slip, the bearer party commander is in a position to assist the bearers. Should the casket be very heavy or the steps long, the end bearers can move their hands to the end of the casket to assist in bearing the weight, or the bearer party commander can assist.
- e. Once the bearer party is completely on a flat surface then the bearer party commander shall give the command **PREPARE TO LIFT – LIFT, OUTWARDS TURN** and continue to move forward with the casket.
- f. On the command **PREPARE TO LIFT – LIFT, OUTWARDS TURN**, the procedure outlined in Section 3 paragraph 9 shall be followed.

9. **Halting and Lowering the Casket**

- a. On the command **HALT**, which is given as the outside feet come to the ground, the bearers are to complete the pace with the next foot and then place the outside foot beside it.
- b. On the command **INWARDS**, the bearers are to rotate the outside hand, so that the fingers are extended beneath the casket with the thumb running up the side, forward of the face.
- c. On the command **TURN**, the bearers are to turn and face the casket, the chest approximately 30 cm from it, taking the weight with the outside hand for a moment until they can withdraw the inside arm from beneath the casket so as to be able to place the inside hand back underneath the casket.
- d. On the command **PREPARE TO LOWER – LOWER**, the bearers are to lower the casket gently, ensuring that it remains level, to arms length or to the required height for the trestles or to allow it to be fed into a hearse or onto a gun carriage.

10. **The Feed into the Hearse or onto the Gun Carriage**

- a. On the command PREPARE TO FEED – FEED, the bearers, moving it inside hand to outside hand, feed the casket into the hearse. The foot end bearers are to guide it into the correct position. As each pair “lose” the casket, on the command UP from one of them, they resume the position of attention. The foot end bearers must ensure that the casket is placed into the hearse and is secure before they act on the UP.
- b. On the command OUTWARDS – TURN, the bearer party turn to face the hearse without bending the knee.

11. Replacing Headdress

- a. On the command PREPARE TO RECEIVE HEADDRESS – RECEIVE, the bearer party will bend both elbows, at the same time extending the fingers vertically and together to a position, with the palms approximately 20 cm apart, in front and to the right or left of the outside shoulder. The two headdress bearers are to act together and move along their respective files distributing the headdress to each bearer, ensuring each receives the correct headdress (they should be marked). Upon completion, the headdress bearers return to their previous positions two paces in rear of the bearer party commander.
- b. On the command REPLACE – HEADDRESS, the bearers shall replace their headdress as detailed in Chapter 2.
- c. On the command ATTEN – TION, the bearers are come to the position of attention and, after the standard pause:
 - (1) step off in quick time and march to their transport out of sight of the mourners if the bearer party is to travel separately to the place of internment; or
 - (2) step off in slow time and take up a position to cover the front, centre and rear two paces to the outside of the hearse and leaving space for the honorary pallbearers. The bearer party commander will move two paces centre rear of the hearse with the headdress bearers two paces to his rear and covering off their respective files.

12. **Procession Words of Command.** The bearer party will act on the words of command of the funeral commander (the firing party commander for small funerals).

13. **The Halt of the Hearse or Gun Carriage.** Before the hearse arrives at its halt point, the bearers, on orders from the bearer party commander, will step short and regain their previous positions in rear of the hearse.

- a. On the command HALT, the bearers and the hearse should halt together.
- b. On the command PREPARE TO REMOVE HEADDRESS, REMOVE – HEADDRESS, the bearers will carry out the actions detailed in paragraph 11, but in reverse order.
- c. On the command INWARDS – TURN, the bearers will carry out the turn as previously described. If necessary, they can be given OUTWARDS – DRESS ensuring that the foot end bearers are as close to the hearse as is required. Note that before inwards turn is ordered, the funeral director should open the hearse door.
- d. On the command PREPARE TO FEED – FEED, the foot end bearers will grasp hold of the casket handles with their outside hands and the base with their inside hands. On an UP from one of them they will withdraw the casket to a point where they can adopt the “feed” position as previously described. On a second UP they will feed the casket from the hearse inside hand to outside hand. In pairs, the remaining bearers will take the weight also working on an UP until the commander is satisfied that the weight is evenly distributed and the bearer party is in the correct “lift” position.
- e. On the commands RAISE, OUTWARDS – TURN; and SLOW – MARCH, the bearers will carry out the actions already described. The hearse will move off when the casket has cleared its rear. Then with the chaplain leading, the bearer party will make its way to the grave side, manoeuvring carefully, as

necessary, and be ordered to HALT when the left foot end bearers are one pace from, and in line with, the end-edge of the grave. The commander will then order INWARDS – TURN; and PREPARE TO LOWER – LOWER, as already described.

14. **Placing the Casket over the Grave.** When the bearer party commander is satisfied that the bearers are covering off the sides of the grave, he will give the command SLOW – MARCH. The bearers will then step off, side pacing along the side of the grave, the foot end moving first, ensuring that they step over the support poles and straps laid over the grave, until the casket is covered off over the grave. The commander will then order STEADY and the bearers will adopt the position of attention.

NOTE

Care must be taken when positioning the casket over the grave. Bearers must be conscious of the lowering straps and may need to look down to ensure that their feet don't become entangled when moving beside the grave.

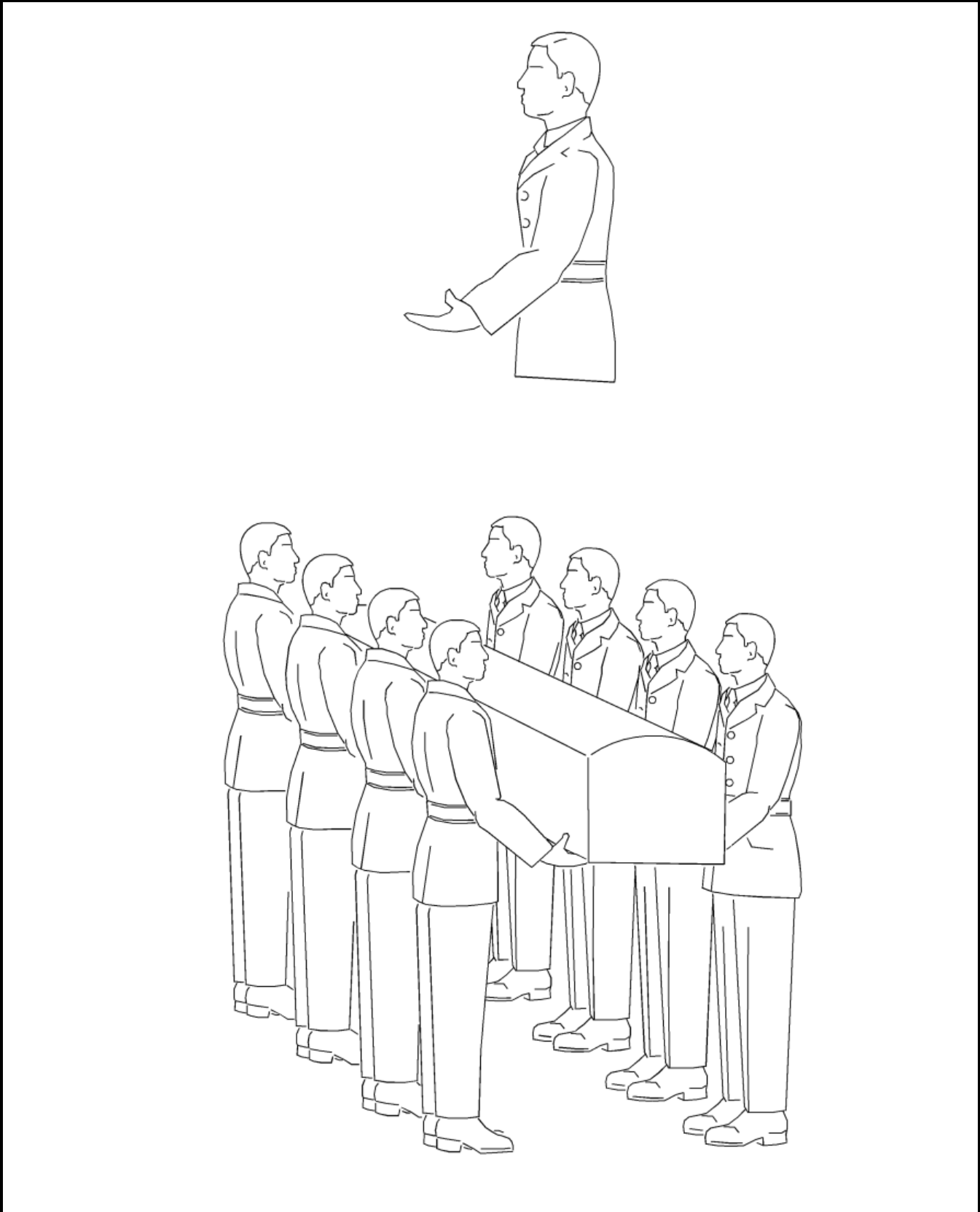

Figure 11-3- 1 Prepare to Lift

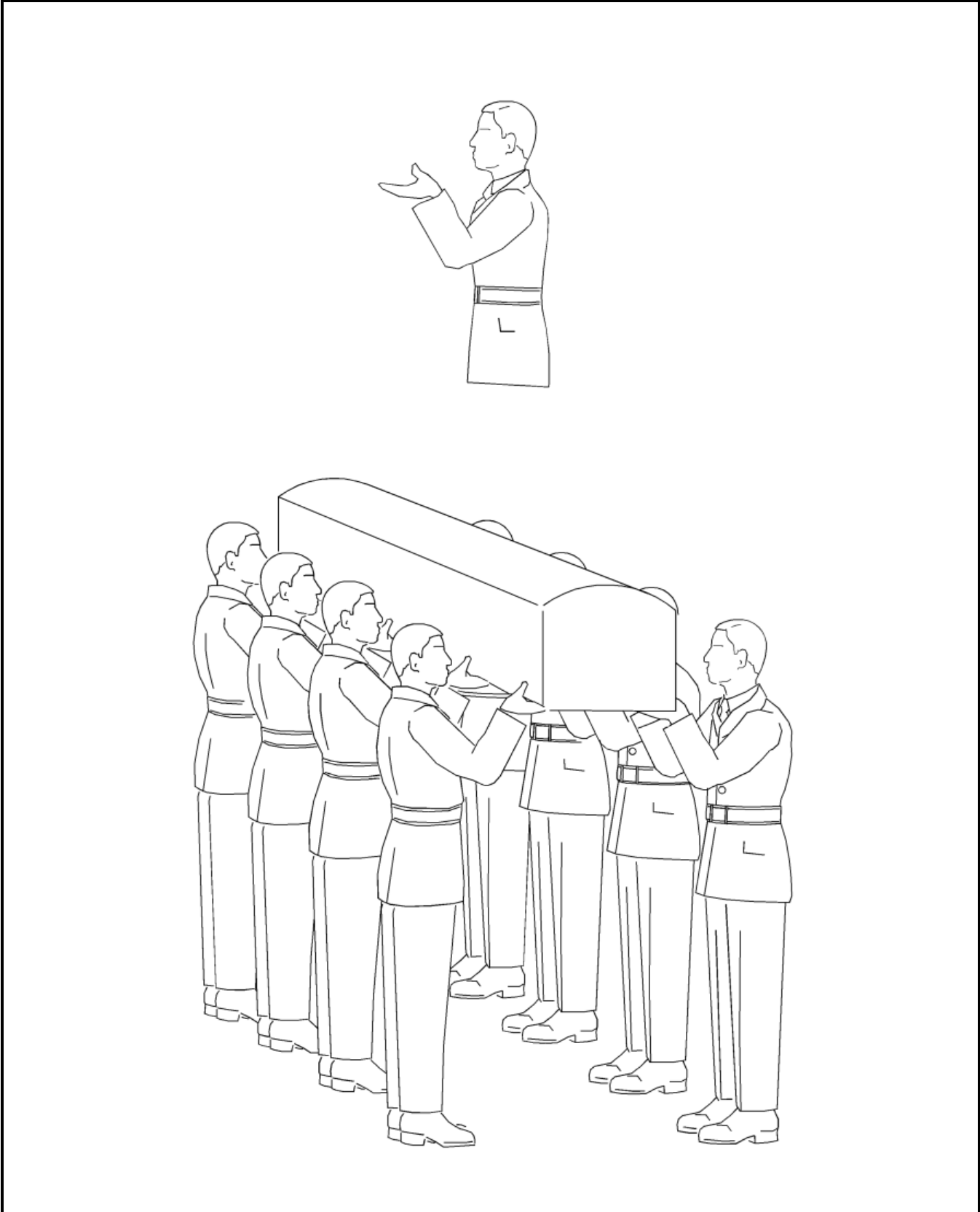

Figure 11-3- 2 Raise – Final Position

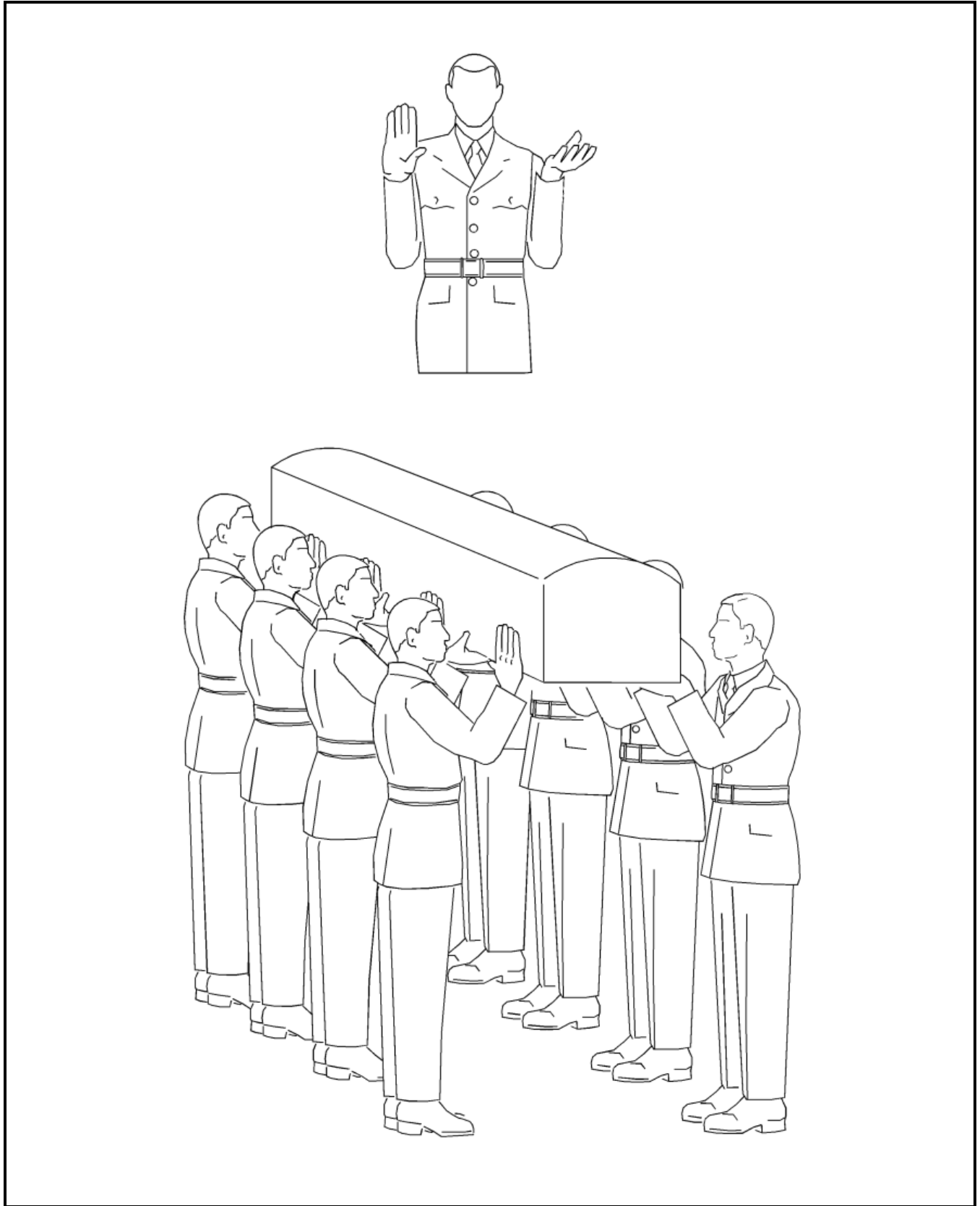

Figure 11-3- 3 Outwards

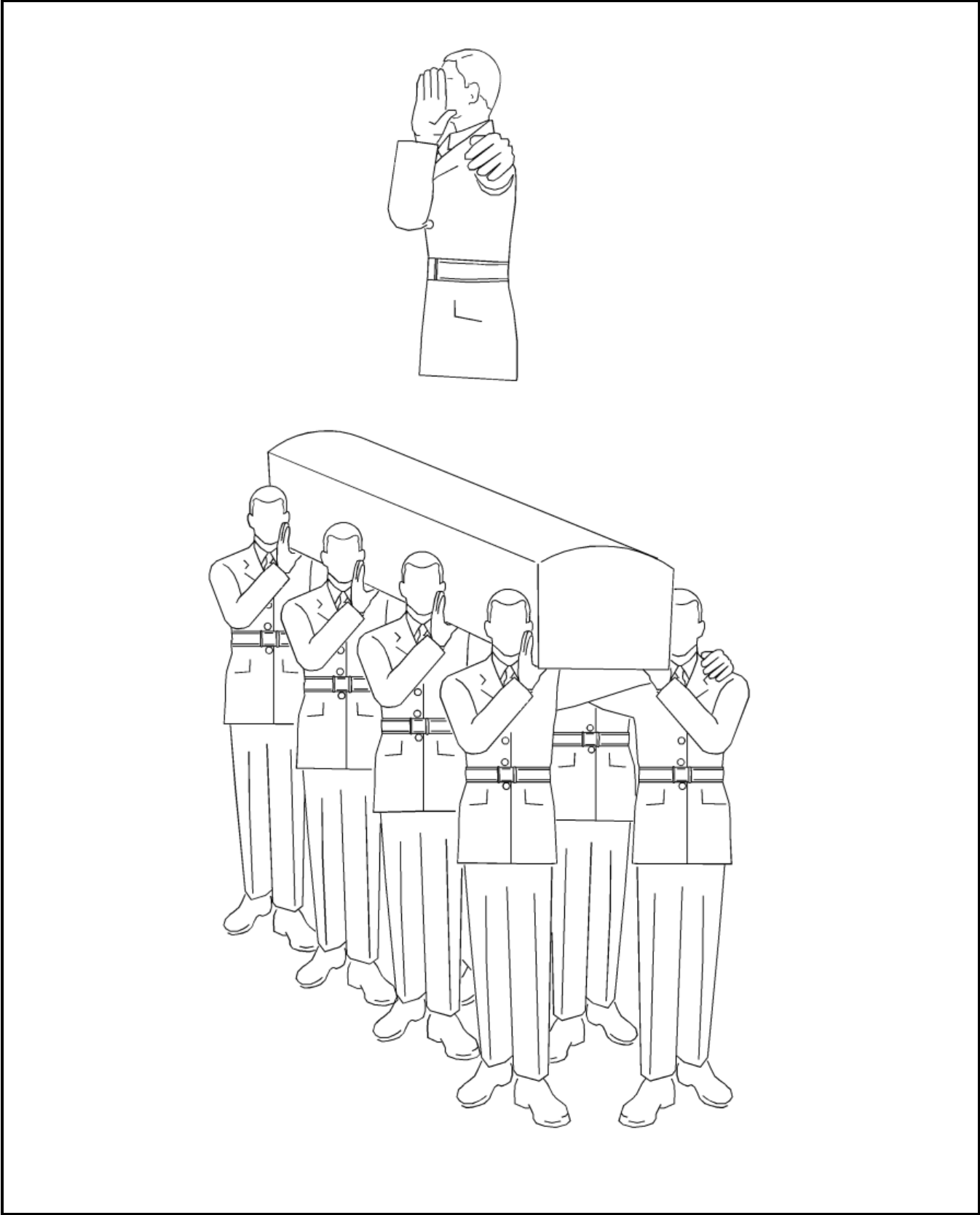

Figure 11-3- 4 Turn

15. **Lowering the Casket.** As soon as possible after the STEADY, the commander will give the command PREPARE TO LOWER – LOWER. The bearers will then take a pace to the rear with the foot furthest from the foot end of the casket and then bend both knees until the knee of the rear leg touches the ground, at the same time gently and evenly lowering the casket until it comes in contact with the supports (Figure 11-3-5). The commander then gives the command ATTEN – TION and the bearers will force both arms to the position of attention. The commander follows the casket to the edge of the grave and kneels with the bearer party.

16. **Feeding the Straps**

- a. The straps should be previously positioned so that they are to the right of each bearer. On the command PREPARE TO FEED STRAPS – FEED, each bearer will grasp the end of their strap with the right hand. Then, on the command STRAPS, the bearers, using both hands, will feed the straps from the bottom vertically up through the handles ensuring that:
 - (1) the centre of each strap ends up under the centre of the casket base; and
 - (2) the excess is fed into the grave out of sight.
- b. On the command STAND – UP, the bearers release the strap and resume the position of attention.

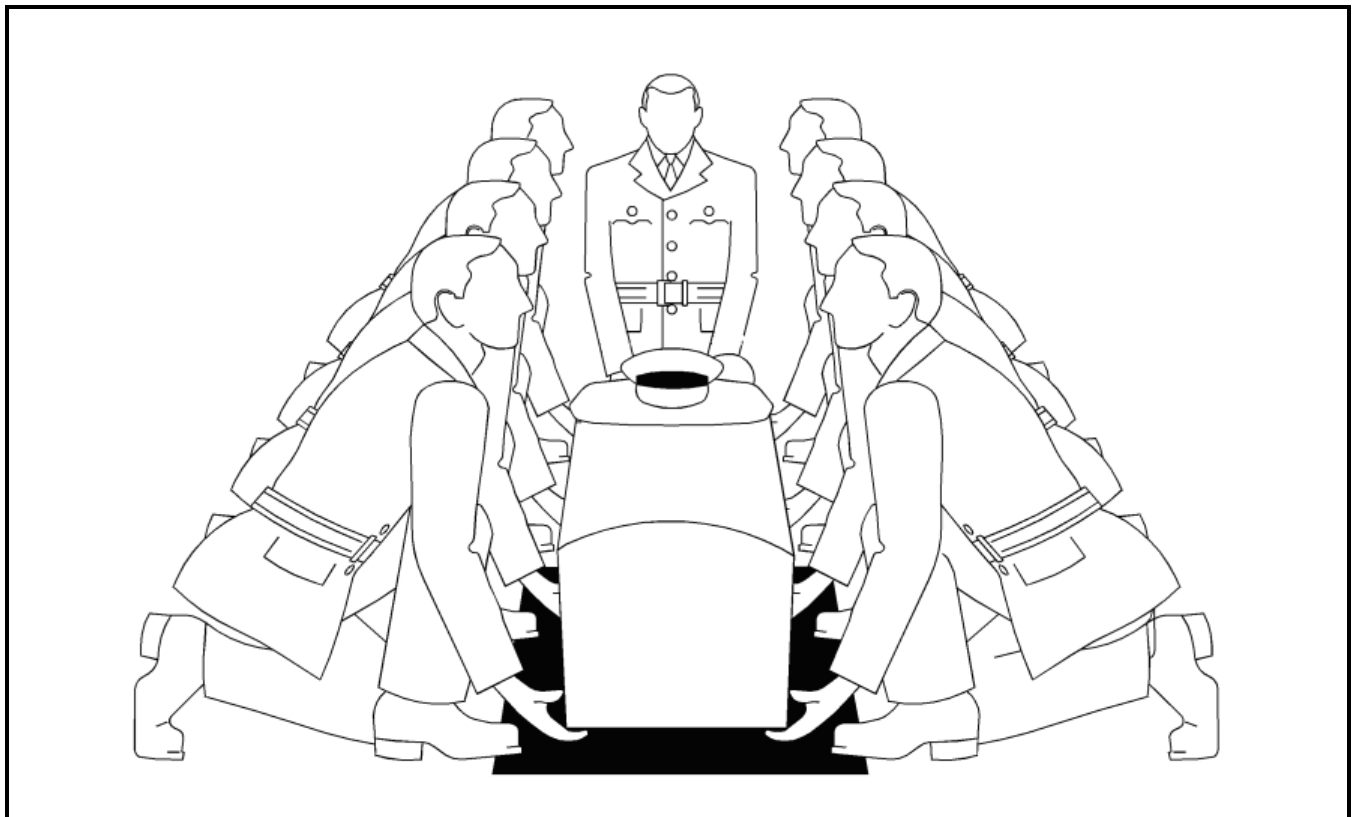

Figure 11-3- 5 Lowering the Casket

17. **Undressing the Casket**

- a. **The accoutrements.** On the command WREATH, the right hand foot bearer will lift up the wreath and place it to his left on the casket. The bearer on the left will put the belt/bayonet onto the wreath and place both items to his left. The bearer opposite will place the cushion with the decorations on the wreath and place it to his right. The bearer to his right will put the headdress on top and place all the accoutrements in front of the commander. The commander will remove them from the casket and retain them in both hands. Bearers on completion of their task will resume the position of attention. If the casket has had to be turned for any reason, the actions above are the same except starting with the headdress.

- b. **Folding the Flag.** The National Flag is to be folded with “quiet dignity”, as noted in A-AD-200-000/AG-000, The Honours, Flags and Heritage Structure of the CF soon to become A-DH-200-000/AG-000, The Heritage Structure of the CAF, Chapter 4, Section 2, paragraph 19. On the command PREPARE TO FOLD FLAG – FOLD, the bearers on the right will fold the flag so that the edge reaches the far side of the casket. The left side bearers will fold the flag so that the edge is level with the far side. When this is completed, the foot end bearer will fold the flag once to the left. The remainder of the right side bearers will then, in turn, fold the flag to their left until the flag is neatly folded in front of the commander. The commander will then place the accoutrements onto it and remove the flag from the casket. Each bearer, on completing their fold and having smoothed the flag flat, will return their arms to the position of attention.

18. **Lifting, Lowering and Roll Straps**

- a. **Lifting the Casket.** On the command TAKE UP – STRAPS the bearers adopt the kneeling position as per paragraph 15 above. They will take control of the straps. Both hands should end up in a full grip on the strap with the right hand above and just touching the left, with the thumbs uppermost. On the word of command STAND – UP, the bearers resume the position of attention, at the same time allowing the straps to run through both hands, until the arms are at their fullest extent in the front centre of the body, with the straps taut. On the command PREPARE TO LIFT – LIFT, the bearers take the weight on the straps and lift the casket evenly just clear of the supports (Figure 11-3-6). At this point, the two persons previously detailed will remove the supports.
- b. **Lowering the Casket.** On the command PREPARE TO LOWER – LOWER, the bearers will allow the straps to slide slowly through their hands, so that the casket is lowered gently and evenly into the grave (Figure 11-3-7). During this movement, if the casket becomes uneven the commander may order STOP; LOWER ON THE LEFT/RIGHT/FEET/HEAD; STOP; and PREPARE TO LOWER – LOWER, as necessary, until the casket has returned level and has settled at the bottom of the grave.

NOTE

Ensure that spreaders are placed in the bottom of the grave to facilitate the removal of the straps once the casket is lowered.

- c. **Roll Straps.** On the command PREPARE TO ROLL STRAPS – ROLL, the bearers to the right of the commander will let the straps fall to their right rear and return both hands to the position of attention. The bearers to the left of the commander will roll the straps from the underside with both hands, forearms parallel to the ground and with the elbows tucked into the sides. Upon completion the bearers will adopt the position of attention in unison with the rolled strap in their left hand.

19. **The March Off.** On the command OUTWARDS – TURN, the bearer will turn to face the commander. Then:

- a. On the command QUICK – MARCH, the bearer party will step off and march to a previously designated position, the commander bringing up the rear;
- b. On arrival at their correct position, the commander will order the bearer party to HALT; and REPLACE – HEADDRESS. This time the commander will be the last to receive his headdress so that one of the headdress bearers can take the flag and accoutrements before he receives his own headdress. The commander will then order the bearer party to LEFT/RIGHT – TURN, so that they are facing the grave;
- c. On the command PRESENT – ARMS from the firing party commander, the bearer party commander will salute and complete the compliment when the firing party commander gives the order SHOULDER – ARMS. If there is no firing party, the commander will salute on the first note of “Last Post” and complete the compliment on the last note of “Rouse”; and
- d. After the order DIS – MISS is given, the bearer party commander or the funeral commander will retrieve the flag and accoutrements from the headdress bearer and present them to the next-of-kin.

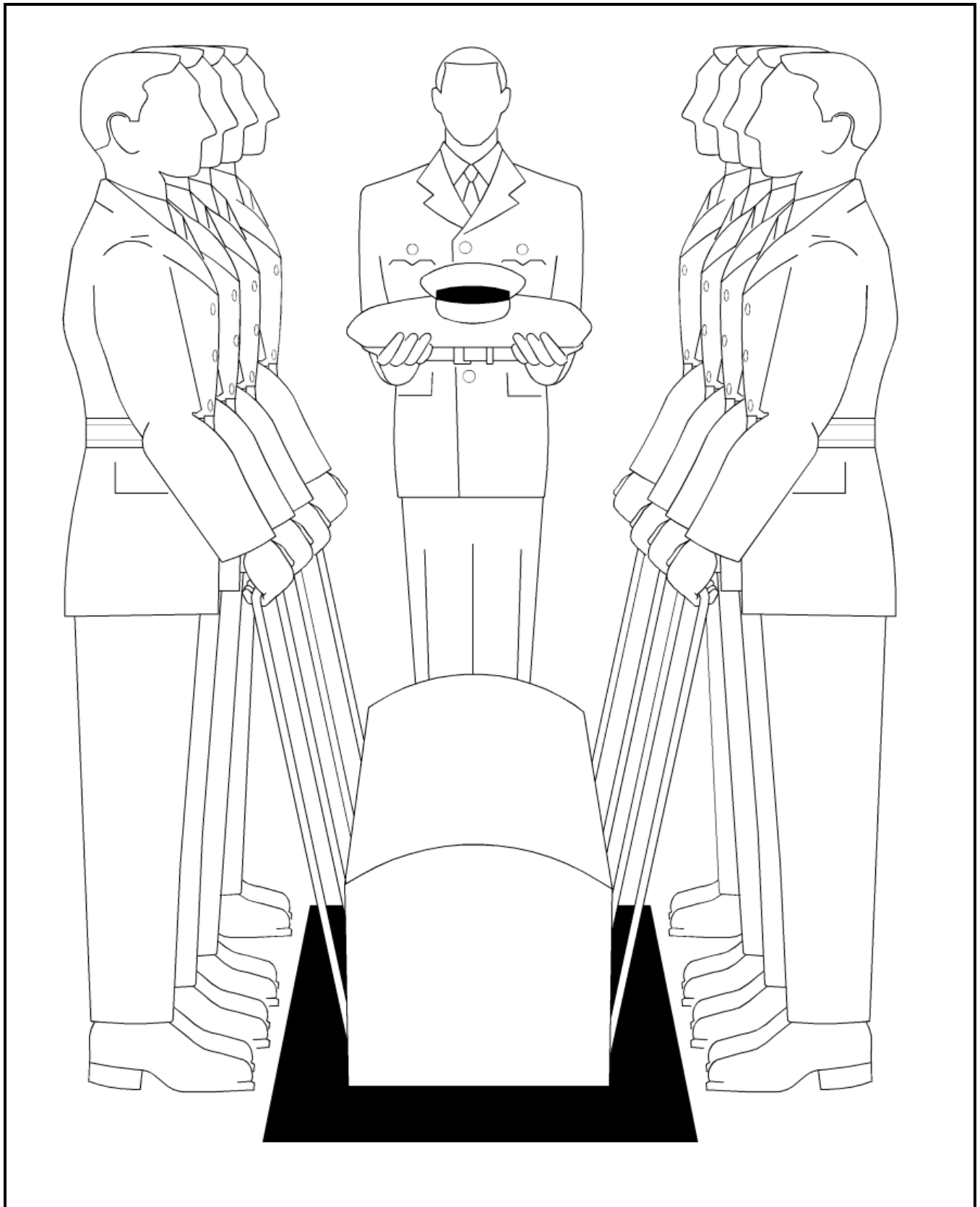

Figure 11-3- 6 Lifting the Casket

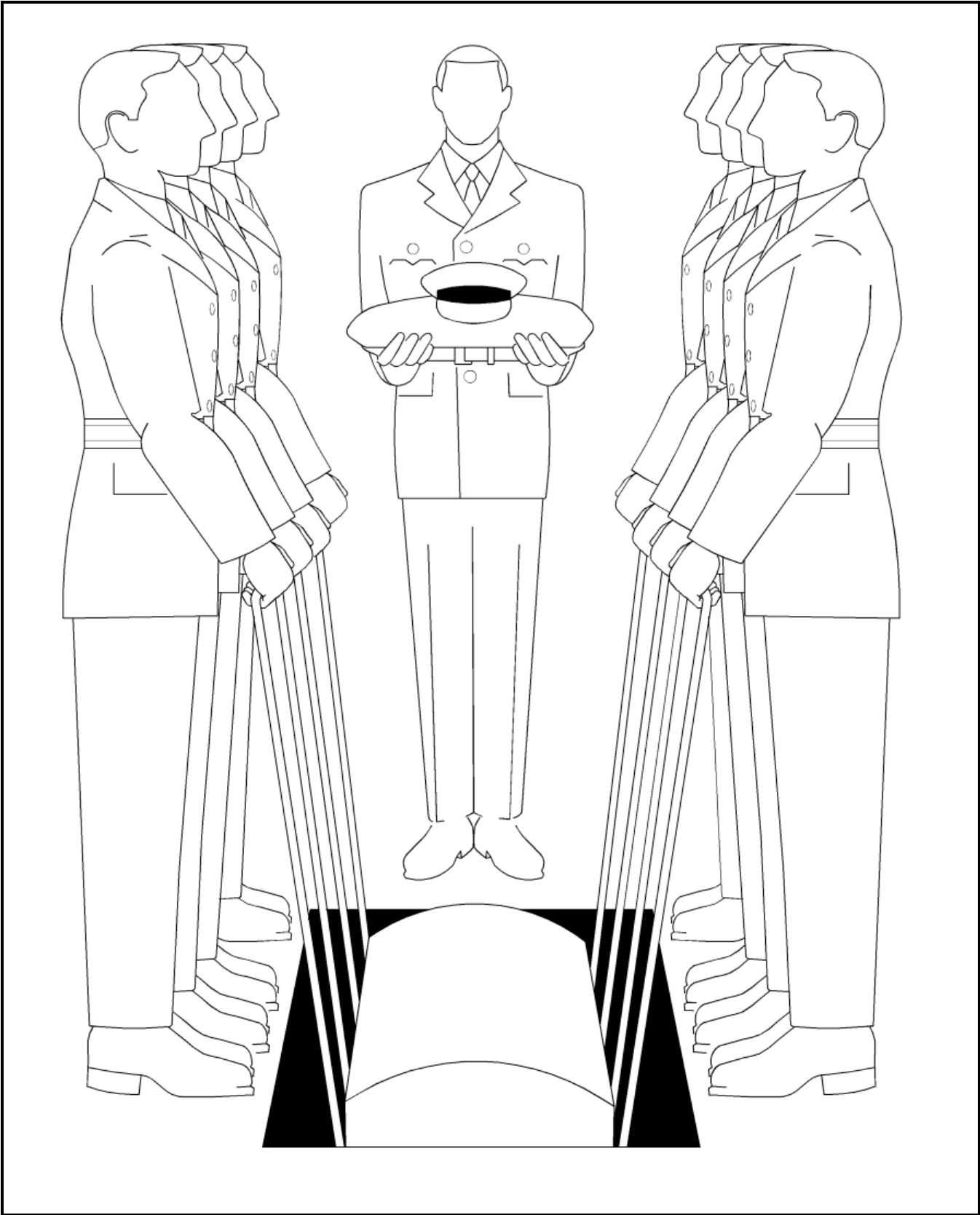

Figure 11-3-7 Lowering the Casket

PROCEDURE FOR HONORARY PALLBEARERS AND INSIGNIA BEARERS

20. On arriving at the church or chapel, honorary pallbearers and insignia bearers (see Section 2, Table 11-2-1, No. 9) shall be escorted by the ushers to their seats, which are at the left front facing the altar.
21. After the service, the chaplain shall move forward, down the centre aisle to a position in line with the sixth row of pews.
22. When the chaplain has halted, the insignia bearers shall move forward to the casket and pick up the insignia cushions. At the same time, the honorary pallbearers shall form up behind the chaplain in their order of seniority in two ranks (see Section 2, Table 11-2-1, No. 8).
23. When the procession moves forward, the honorary pallbearers shall follow the chaplain and form up outside the church, on the sidewalk, in two ranks, facing inwards with four paces between ranks (Section 2, Figure 11-2-4), with the senior farthest from the church.
24. Honorary pallbearers shall salute as the casket is carried through the ranks, and remain at the salute until the casket is secured on the gun carriage or in the hearse.
25. When the casket has been secured on a gun carriage, the honorary pallbearers shall turn outward facing the carriage, and move in slow time to their positions. If the casket has been placed in a hearse and the honorary pallbearers will be travelling by vehicle, they shall move slowly and formally to their vehicles.
26. The insignia bearers shall follow behind the casket, carrying the insignia cushions.
27. When the casket is placed in a hearse, the insignia bearers shall place the insignia cushions on the foot of the casket in the hearse and proceed to their vehicles with the honorary pallbearers.
28. On arriving at the graveside with a hearse, the insignia bearers shall proceed to the hearse, pick up the insignia cushions, step back and wait for the casket to be removed, then proceed to the grave following the casket. When the casket is placed on the grave, the insignia bearers shall place the insignia cushions between the headdress and the hilt of the sword or bayonet, step back, salute, then take up a position with the chief mourners.
29. On arriving at the graveside, the honorary pallbearers proceed to the hearse, forming in the same order relative to it as when the transfer of the casket took place and salute the casket as it is being removed from the hearse.
30. Honorary pallbearers then shall step off in slow time, on either side of the casket, on the command of the commander of the bearer party and proceed toward the grave, taking up their positions beside the graveside (see Section 2, Figure 11-2-6).

SECTION 4

THE UNLOADING OF A CASKET FROM AN OVERSEAS AIRCRAFT

GENERAL

1. Whenever the remains of a deceased member of the Canadian Armed Forces are returned by aircraft from overseas to Canada for burial, a bearer party shall be mounted for unloading the remains in Canada.

NOTE

Remains are loaded onto an aircraft with the head oriented forward. As airplanes fly with a nose-up attitude this prevents embalming fluids from pooling in the head of the deceased (see CFACM 7-400 (1), Chapter 4, section 2, paragraphs 3 and 4).

2. If requested by the country concerned, a similar bearer party shall be mounted to load the remains of a member of an Allied armed force who died in Canada onto an aircraft for shipment overseas. The demands of common courtesy shall be the guide.

3. No band shall be in attendance.

4. The transference of a deceased from one mode of transport to another does not constitute a part of the ceremonial procedures established to honour a deceased service member. Therefore, guards should not be mounted to receive or pay compliments to the deceased. This does not preclude the attendance of military officials who will pay compliments.

COMPOSITION OF THE BEARER PARTY

5. The composition of the bearer party may vary to suit local conditions, but it shall consist of not less than one non-commissioned officer and eight corporal/privates.

POSITION OF THE BEARER PARTY

6. The escort officer or the unit liaison officer will arrange for the casket to be removed from the aircraft by mechanical or other means. The position of the bearer party may vary to suit local conditions, but shall be as agreed upon by the party commander and the escort officer before the remains are removed from the aircraft. If possible, the casket or shipping case should be draped with the National Flag before it is removed from the aircraft.

7. Generally, the bearer party shall position themselves in two equal ranks, one on either side of the aircraft hold or ramp, or to the rear of the lifting device if the casket must be removed by mechanical means from the aircraft.

8. The escort officer shall position himself near the casket in order to direct removal of the body from the aircraft.

9. The bearer party commander shall position himself on the right flank of the party facing towards the front of the aircraft.

10. Visiting officials shall position themselves midway between the aircraft and the funeral hearse or transport vehicle.

REMOVAL OF THE CASKET

11. If the casket is to be removed by mechanical means, the air movements detachment will direct removal of the body to a place in front of the bearer party for transport to the hearse or vehicle.

12. If the casket is to be removed by hand, the bearer party will assist the air movements detachment or local authorities to remove the casket and place it in the hearse or vehicle.

13. The casket shall be lifted and carried to the waiting vehicle as described in Section 3.

14. The escort officer and all visiting officials shall salute on the command LIFT by the bearer party commander and the salute shall be terminated when the casket is placed in the hearse. When moving off the runway, if the hearse or transport vehicle passes the escort officer or visiting officials, they shall salute again as the vehicle passes.

SECTION 5

BURIAL OR SCATTERING OF ASHES AT SEA

BRINGING REMAINS ON BOARD SHIP

1. The guard and bearer party shall be formed up in two ranks facing inwards, on the jetty (Figure 11-5-1) when the gun carriage or hearse moves to the ship's gangway. The ship's ceremonial side party shall be formed on the forward side, at the head of the gangway.
2. As the gun carriage or hearse approaches, the guard shall present arms and remain at the present arms as the casket is removed. After shouldering arms, the guard shall follow the bearer party on board. As the casket is brought on board, the ceremonial side party shall pipe the side.
3. Whenever possible, the casket shall be positioned onboard so that it is fore and aft, with the foot of the casket forward.
4. The guard is formed in two ranks at the head of the casket in an athwartship (lateral) position. The guard rest on arms reversed until the mourners are onboard.
5. During the passage to sea, four members from the guard shall be detailed as the vigil. They are positioned at each corner of the casket, facing outwards, obliquely, resting on their arms reversed.

BURIAL

6. Prior to the ship's arrival at the burial position, the vigil is dismissed and the casket moved to the launching ramp by the bearer party. Prior to being placed on the launching ramp, the accoutrements are removed from the casket.
7. The bearer party remains on either side of the casket when the casket is in position, maintaining their grip on the handles. They shall ensure that the holes in the casket are concealed by the flag.
8. The guard is formed up, fore and aft, facing outboard, in two ranks, resting on their arms reversed. The guard commander is in the rear and the ceremonial side party on the right of the guard.
9. At the commencement of the service, all military personnel, except the guard and ceremonial side party, shall remove headdress.
10. Upon completion of the service, the chaplain shall take one pace back. On this signal, the guard commander shall give the cautionary word of command GUARD and pause to allow all personnel to replace headdress before ordering PRESENT – ARMS.
11. The guard shall present arms from the position of rest on your arms reverse. On the last movement of the present arms, the bearer party shall commit the body to the sea while all officers and personnel not under command shall salute. Simultaneously, the ceremonial side party pipes "Side" and, after a 10 second pause, "Carry On". Salutes shall be maintained during both calls and the interval between. Following the "Carry On", the guard shall be ordered SHOULDER – ARMS, then dismissed.
12. Floral tributes are dropped in the sea on completion of the service.

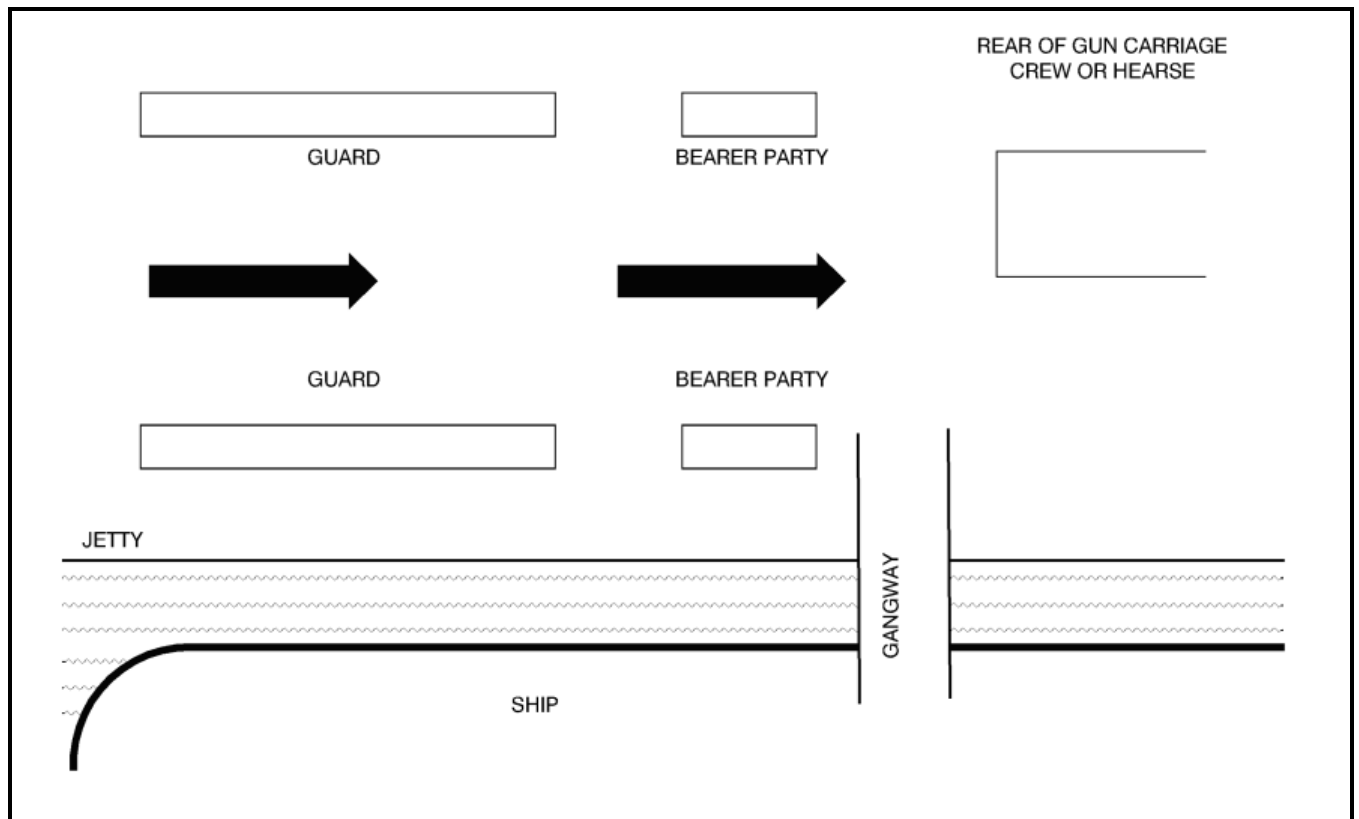

Figure 11-5- 1 Arrival at Ship's Side

SCATTERING OF ASHES

13. The cremation having been completed as noted in Section 2, the ashes are conveyed to the ship by the chaplain. The ship then proceeds to sea to the prearranged position. The ship's ensign is lowered to half-mast.
14. The service is read and at the appropriate moment, the ashes are scattered over the leeward side. The ship's ensign is then hauled close-up, and the ship proceeds.
15. The ship's company attending the service remove headdress before the service begins.

SECTION 6

PROCESS FOR THE CEREMONIAL FOLDING OF THE NATIONAL FLAG OF CANADA

GENERAL

1. The Flag should be held taut in an outstretched manner. Although the preferred and easier way of folding the flag is done with 8 persons the same process can be accomplished with 6 persons should a formal Flag-folding ceremony required. The individuals face each other as illustrated.

Step 1: Persons 2, 4, 6 and 8 stand fast holding the flag taut. Persons 1, 3, 5 and 7 initiate the first movement by passing the sewn edge under to their facing colleagues. On the words of command PREPARE TO FOLD – FOLD persons 2 and 8 will slide their right and left hands respectively toward the centre outer edge of the flag, simultaneously sliding their left and right hand and grasping the corners of the flag. Persons 1, 3, 5 and 7 grasp the flag along the folded edge (what is normally the centre of the flag) ensuring the flag remains taut.

Step 2: The fold in step 1 is repeated, resulting in a quarter of the flag in full length (the tip of the maple leaf shall be facing up).

Step 3: On the words of command PREPARE TO FOLD – FOLD persons 7 and 8 bring their end forward in an upward motion to persons 5 and 6. This fold is done over the hands of the others. Persons 3, 4, 5 and 6 guide the flag and ensure it remains taut. Persons 7 and 8 step back and remain at attention in their original positions.

Step 4: On the words of command PREPARE TO FOLD – FOLD the fold in step 3 is repeated and persons 5 and 6 step back.

Step 5: On the words of command PREPARE TO FOLD – FOLD persons 3 and 4 fold the flag under holding it taut. Persons 3 and 4 step back.

Step 6: On the words of command PREPARE TO FOLD – FOLD persons 1 and 2 fold the flag over holding it taut, resulting in the final form ready for presentation.

Note: It is important to note that the above-mentioned method for folding the flag is to be used for ceremonial presentations and is not intended to be the official method used on a routine daily basis. When flags are lowered or removed as a part of a normal procedure, they are simply folded with quiet dignity.

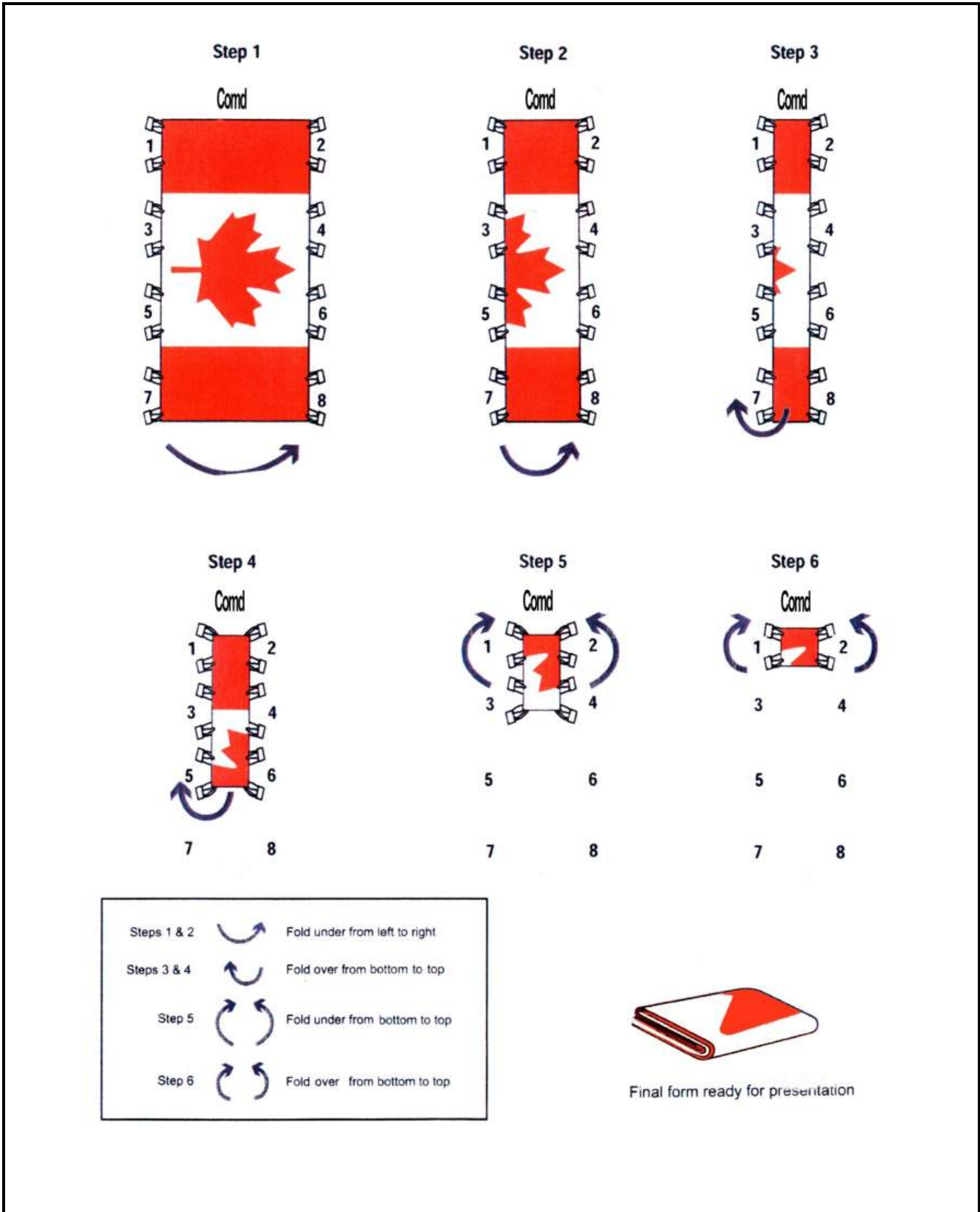

Figure 11-6-1 Flag folding procedure

CHAPTER 12
MISCELLANEOUS CEREMONIAL
SECTION 1
STREET LINING

GENERAL

1. The number of personnel required to line a route is dependent on the length of the route allotted to unit and the interval allowed between service personnel required. The following formula allows you to calculate the number of personnel required:

Distance to be lined (paces) x 2 = Total number of personnel

Interval (in paces)

2. Arms may be carried by units lining the street.
3. Colours may be carried in accordance with Chapter 13, Annex A to A-AD-200-000/AG-000, The Honours, Flags and Heritage Structure of the CF soon to become A-DH-200-000/AG-000; The Heritage Structure of the CAF.
4. Bands must not be placed at points where traffic is uncontrolled. They shall be positioned opposite the Colour party when circumstances permit. Otherwise, they should be positioned conveniently where a side street opens into the route of the procession. The leading rank shall be in line with other personnel lining the route. The bands formation may be adjusted to fit the depth of the space available.

DEFINITIONS

5. **Near End.** The end of the unit from which the procession will approach.
6. **Far End.** The end of the unit farthest away from the direction of the procession's approach.

STREET LINING

7. Markers, one for each company, shall be pre-positioned by the chief warrant officer, commencing from the near end of the battalion position, one pace from the curb.
8. The battalion shall be formed in company blocks (no intervals between platoons), in line, sized and with bayonets fixed (except at funerals). The battalion then shall be marched to the street lining location from the near end, each company being halted on its marker beginning with the rear company of the battalion, in accordance with Table 12-1-1 and Figure 12-1-1.
9. The battalion commanding officer shall be positioned one pace in front of the marker of the company at the near end, and the adjutant shall be positioned directly opposite the commanding officer, one pace in front of the first member of the front rank. The deputy commander shall be positioned one pace in front of the last member at the far end, on the same side of the road as the commanding officer, and the chief warrant officer shall be positioned directly opposite the deputy commander, one pace in front of the last member of the front rank of the last company.
10. The company commanders shall position themselves one pace in front of the rear rank at the near end of their company (in front of the marker or in front of the second member if the commanding officer is in front of the marker), and the company deputy commanders shall position themselves one pace in front of the rear rank at the far end. The master warrant officer shall be positioned opposite the company deputy commander.

No.	Command	By	Action	Remark
1	Just before reaching his own coy marker, the Coy Comd will move off to his left and halt in the centre of the street, allowing his coy to continue marching until its right flank is one pace past the marker.			
2	COMPANY – HALT	Coy Comd	Coy comes to a halt.	
3	COMPANY ADVANCE, LEFT – TURN	Coy Comd	Coy turns left.	
4	COMPANY WILL FORM TWO RANKS, FORM TWO – RANKS	Coy Comd	Coy forms two ranks.	
5	COMPANY, RIGHT – DRESS	Coy Comd	Coy acts as ordered.	
6	COMPANY, EYES – FRONT	Coy Comd	Coy acts as ordered.	
7	FRONT RANK, BY THE RIGHT, QUICK – MARCH	Coy Comd	The front rank shall march across the road.	
8	FRONT RANK – HALT	Coy Comd	The front rank halts.	
9	COMPANY, RIGHT – TURN	Coy Comd	Coy turns to the right.	
10	COMPANY, TO A ___ PACE INTERVAL, IN TWO SINGLE FILES, QUICK – MARCH	Coy Comd	The first service member of the rear rank wheels into position the required number of paces past the marker, the second member wheels into position the same number of paces past the first, and the remainder carry on in a like manner. The first man of the front rank wheels into position opposite the marker and the remainder carry on as did the rear rank.	See Figure 12-1-1. When arriving in position, each member halts, observes the standard pause, turns to face the centre of the street, covers off the member on the opposite side, dresses on the marker or No. 1 of the front rank, and awaits further orders.

Table 12-1- 1 (Sheet 1 of 2) Street Lining

No.	Command	By	Action	Remark
11	COMPANY, ORDER – ARMS	Coy Comd	The coy orders arms.	
12	COMPANY, STAND AT – EASE	Coy Comd	The coy stands at ease.	
13	<p data-bbox="302 495 1308 527">As the procession approaches, each Coy Comd shall order, ___ COY, ATTEN – TION.</p> <p data-bbox="870 569 951 600" style="text-align: center;">NOTE</p> <p data-bbox="773 642 1049 674" style="text-align: center;">See also paragraph 16.</p>			

Table 12-1-1 (Sheet 2 of 2) Street Lining

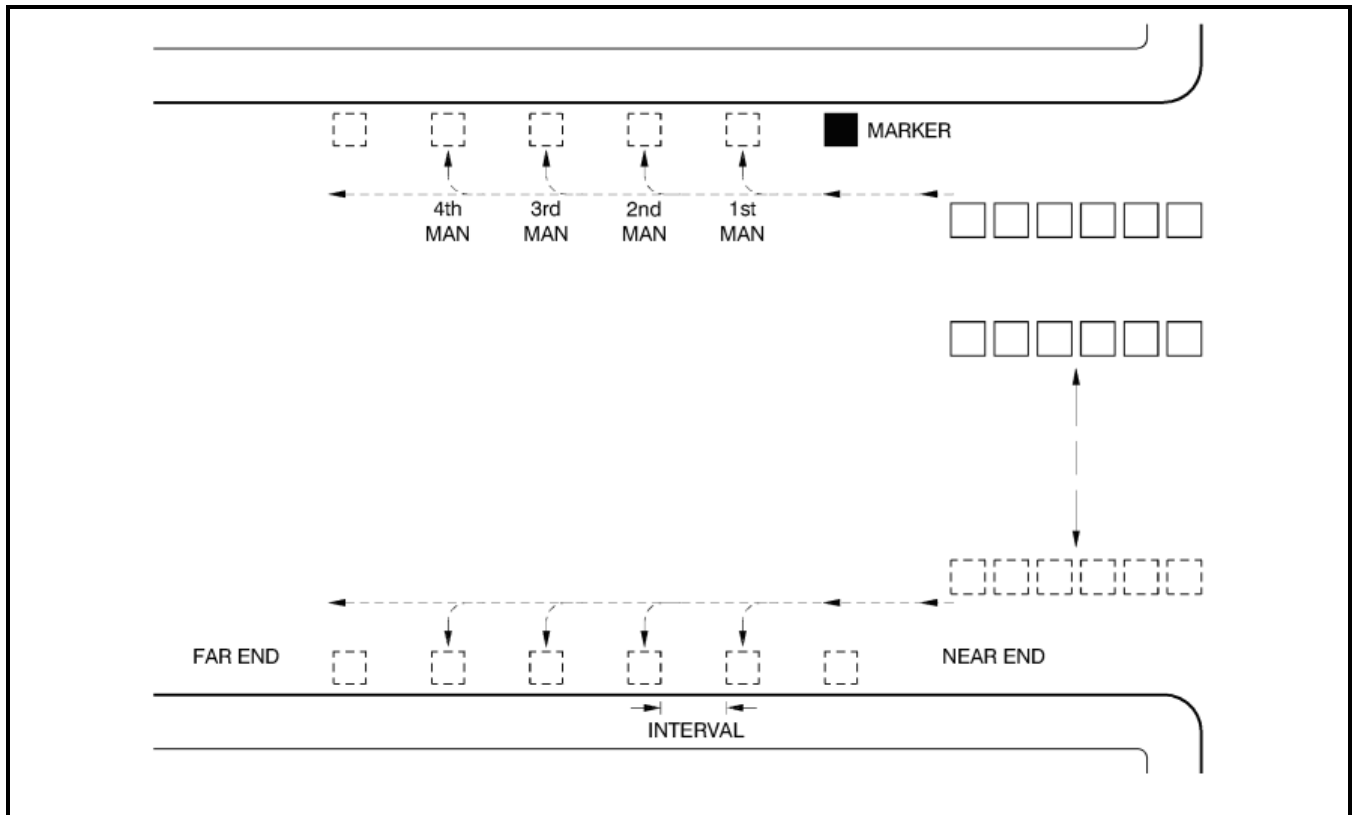

Figure 12-1- 1 Street Lining

11. The remaining officers shall position themselves one pace in front of the front and rear ranks of their companies, equally spaced across the frontage of each rank.
12. The remaining warrant officers and the sergeants shall be dispersed within the ranks of their respective companies.
13. The Colours shall be positioned in the centre of the battalion, on the right hand side of the road as seen by the procession.
14. As the carriage or vehicle containing the royal personage or dignitary closes to within 20 paces of the battalion's position, the commanding officer shall order **IN SUCCESSION OF COMPANIES, PRESENT – ARMS**. Beginning with the company at the near end, each company commander shall order his company to present arms as the carriage or vehicle closes on the company's position.
15. If the procession is to return, the battalion and the company commanders shall take post on the other flank of their commands in front of the front rank. The Colours shall cross the road. Thus commanders and Colours are always stationed on the procession's right.

FUNERALS

16. As the head of the funeral procession approaches the commanding officer shall order **IN SUCCESSION OF COMPANIES, PRESENT – ARMS**. Beginning with the company at the near end, each company commander shall order his company to **PRESENT – ARMS**; then **REST ON YOUR ARMS – REVERSED**, as the firing party or leading detachment approaches (see also Chapter 11, Section 2, paragraph 46).
17. When Colours are on parade for royal or state funerals, they will be brought to the carry position and the Colour party will shoulder arms. Colours will only be lowered and arms presented by the Colour party if the deceased, or one of the mourners are entitled to that complement.

DISPERSAL

18. Following the passing of the procession, troops should remain in position for approximately 10 minutes in order to facilitate the normal dispersal of crowds. The battalion is then reformed on the lead company by reversing the procedures and marched off to the dispersal area.

SECTION 2

FREEDOM OF THE CITY

GENERAL

1. The granting of the Freedom of the City is a traditional means for a municipality to honour a unit of the Canadian Armed Forces (CAF). The granting is, therefore, a private matter between civic officials and the unit concerned, and the decision to grant this symbolic freedom rests with the municipal authorities. This honour may be granted to both regular and reserve components. It is common for municipal authorities to issue two signed scrolls (one for the unit, the other to be kept as part of the official record by the municipality) with the text of the proclamation. The wording of the text is the responsibility of the municipal authority.

THE CEREMONY

2. The unit to be granted the Freedom of the City marches towards city hall, in column of route, Colours cased and bayonets unfix. As the unit approaches city hall, the chief constable stands in the centre of the road to bar the unit from proceeding further. A light movable barrier may also be used.

3. The unit halts at the barrier. The chief constable challenges the unit on its identity and the commanding officer responds with the unit's title. The chief constable then calls for the unit to "Advance one and be recognized". The commanding officer advances to the barrier.

4. The commanding officer, accompanied by the chief constable, then marches to the door to city hall. The commanding officer knocks on the door three times with the pommel of his sword. The door is opened by the mayor and the commanding officer declares his name and that of the unit. The mayor, accompanied by the city council, forms up at the entrance to city hall. The mayor then reads the proclamation proclaiming the Freedom of the City. The commanding officer accepts the freedom and returns to the unit.

5. The chief constable then causes the barrier to be removed.

6. The unit will fix bayonets, and uncase the Colour. The unit marches past, with the mayor taking the salute.

REPORTING

7. Following the granting of the Freedom of the City, the following information shall be forwarded to NDHQ, Attention: Director History and Heritage (DHH):

- a. unit granted the Freedom of the City;
- b. city; and
- c. date of ceremony.

EXERCISING THE FREEDOM

8. A unit may exercise its freedom as arranged between the civic authorities and the unit.

9. The procedure is the same as that for granting the freedom, except that:

- a. the unit will march to the city hall with bayonets already fixed and carrying Colours; and
- b. in the mayor's proclamation, the unit is welcomed and invited to exercise its freedom.

10. The report in paragraph 7 shall be forwarded to DHH.

SECTION 3

RETREAT (SUNSET) AND TATTOO CEREMONIES

GENERAL

1. These ceremonies take place at sunset. The simplest one is a bugler sounding "Retreat" while the duty sergeant lowers the National Flag. On special occasions, a guard is mounted to participate in Retreat, accompanied by a band or massed bands, and, for the most elaborate occasions, a full evening ceremonial routine is carried out.
2. The origins of these ceremonies lie in two evening routines formerly carried out by soldiers:
 - a. The first occurred at sunset, when soldiers fired evening guns, withdrew into fortified camps and cities, locked the gates, and, as the sun set and darkness approached, lowered their flags for the night. This was Retreat. Originally, the calls sounded to order this routine were beaten on drums and the routine is still commonly called "beating the retreat".
 - b. The second routine followed at or near dusk, when the night watch was set. Rounds were made to check sentries (with drum or bugle calls sounded to indicate when the "First Post" and "Last Post" were reached). During this period, the drums beat a warning for all to return to barracks, and often the band played entertainment tunes, an evening hymn and, finally, the National Anthem. This became known as Tattoo, from the Flemish words "tap toe", meaning "turn off the taps" in the inns and bars, since the soldiers had to leave.
 - c. Shortly after "Last Post", the bugler sounded the call "Lights Out". No other calls or gun shots were allowed until morning, except for the sounding of the alarm.
 - d. The two routines often blended together, and were generally and collectively known as Retreat. Today they may be performed separately or as one.
3. Modern customs often include additional music and marching displays. When a corps of drums, bugles or pipes and drums are present, they should perform the traditional drum beats and marches. The sounding of the calls, whether by bugle or in an orchestrated version, should remain the focus of the ceremony.
4. The sequence of a full evening ceremony conducted for a visiting dignitary and guests is:
 - a. the review of the guard;
 - b. Retreat (at Sunset);
 - c. Tattoo; and
 - d. the departure.

REVIEW OF THE GUARD

5. The guard may be either a working or ceremonial quarter guard or a guard of honour, depending on the availability of personnel and the rank of the visiting dignitary (see Chapter 10). The guard shall form up in two ranks facing the dais, with the band in the centre rear of the guard.
6. Appropriate compliments shall be paid when the reviewing officer arrives at the dais. The reviewing officer normally inspects the guard. Following the inspection, the guard marches past, in quick time, in line or column.

7. After the march past, the guard returns to its original position. The band takes up a new position on the right flank of the guard between the march past line and the inspection line or in an alternate position suited to its subsequent involvement in the ceremony.

RETREAT (SUNSET)

8. At the exact time of sunset, the guard commander orders PRESENT – ARMS, and:

- a. the guard acts as ordered;
- b. the band plays “Retreat” (“Orchestrated Sunset”), or, if no band is present, the bugler sounds “Retreat”; and
- c. the National Flag is slowly lowered.

9. When the flag has been lowered and the call completed, the guard commander orders the guard to shoulder arms. If Colours are being carried, they are cased. If there is to be no Tattoo, the guard may then carry on with its duties as noted in paragraphs 15 and 16.

TATTOO

10. Tattoo normally follows Retreat during twilight (see also paragraphs 20 and 21). Even when performed for purely ceremonial purposes, the routine usually includes the sounding of “First Post” and “Last Post”, and these calls are included in the sequence below. Unless it is to participate in the display, the guard stands at ease.

11. The routine traditionally starts with the sounding of “First Post”, which may be followed by drum beating and a band display for entertainment. There are no set tunes for Tattoo, though the pause notes “Three Cheers” are often played before and after the chosen marches, with “doublings”, played between each march.

12. An evening hymn may then be played.

13. Following the hymn, the guard commander orders PRESENT – ARMS and the band plays the National Anthem, “O Canada” (see also Chapter 7 to A-AD-200-000/AG-000, The Honours, Flags and Heritage Structure of the CF soon to become A-DH-200-000/AG-000; The Heritage Structure of the CAF).

14. The guard commander then orders SHOULDER – ARMS. Immediately thereafter, “Last Post” may be sounded.

THE DEPARTURE

15. The guard commander marches to the dais and requests permission to carry on with the night’s duties. (If no guard is in attendance, the drum-major requests permission to march off.)

16. The guard commander returns to his position and orders the appropriate compliment to the reviewing officer. Following the compliment, the guard and band march off the parade ground.

COMPLIMENTS

17. Compliments are paid to the reviewing dignitary on arrival and before the guard marches to its duties.

18. Compliments are also paid during the sounding of “Retreat” as the National Flag is lowered, and during the playing of the National Anthem.

19. Compliments are not paid during “Last Post”, which is sounded as a routine duty call.

TATTOOS INDOORS AND AT DUSK

20. A Tattoo may be performed separately, indoors or out, solely for the purposes of presenting an elaborate martial show for entertainment purposes. Under these circumstances, "First Post" and "Last Post" are often not sounded since no attempt is being made to simulate a working routine.

21. If the National Flag is left flying during an outdoor Tattoo and lowered at the conclusion of the ceremony:

- a. it shall be illuminated after sunset; and
- b. "Retreat" (or "Orchestrated Sunset") is sounded or played before the National Anthem.

SECTION 4

THE SUNSET CEREMONY (NAVAL)

INTRODUCTION

1. The Sunset Ceremony is a display which combines elements of the Retreat, Tattoo and other ceremonial procedures. Field guns and a rifle Feu de Joie are fired to symbolize the origins of these ceremonies, when evening guns were fired and the night watch proved their weapons and cleared damp charges for the night.

NOTE

This ceremony is considered to be an "Exhibition and Display". As such special drill sequences are performed to memorized routines and without the normal sequence of commands (see also Chapter 1, Section 1, paragraph 16).

2. The ceremony was created by the navy based on naval battalion and naval field battery drills, and eventually evolved into the format described below. The ceremony is designed for:

- a. a 50-person guard;
- b. a section (two guns) of field artillery;
- c. two bands, one brass-reed and one bugle band (from the pattern of the Royal Marines band and drums, which is based on an infantry corps of drums and regimental band); and
- d. one flag signaller.

3. Naval ranks and appointments are used in this section because of the ceremony's origins, with equivalents noted in paragraph 12. Gun drill for the naval field guns normally used in the Sunset Ceremony is contained in Annex A.

GENERAL

4. The ideal parade ground for this ceremony is 75 metres square.

5. Units participating in the ceremony shall form in an assembly area removed from the view of spectators around the parade ground. They shall form up in the following order of march: the bands, the guard, and the No. 1 and No. 2 Gun Crews, one behind the other. When forming the guard, it shall be positioned so that, after marching on by the most direct route, halting and turning to face the dais, the rear rank of the guard will be the rank closest to the dais. This will allow the guard to march past, during Phase 3 of the ceremony, with its right flank closest to the dais and its front rank leading.

6. Prior to marching onto the parade ground, the guard shall be numbered in two divisions so that centre rank personnel of each division knows the direction in which to move to form two ranks during Phase 4 of the ceremony. The centre file of each division shall also be identified so that guard members know the file on which to dress when required to dress by the centre.

7. The guard shall march on in column of route, the guard commander positioning himself two paces in front of the centre file and the guard officer, two paces in rear of the centre file.

8. It is preferable that the entrance to the parade ground be situated to the right of the dais (when facing the dais). Should the entrance be situated to the left of the dais, the guard shall be marched on in reverse order, i.e., left flank leading, so that it may be marched directly into position.

9. The positioning of the guns and the direction of fire must be determined prior to the ceremony, bearing in mind the proximity of spectators, the guard and bands.

10. In order to facilitate the precision and exactness that this ceremony requires, the parade ground should be suitably marked to indicate where the guard and bands will perform movements on the march.

SEQUENCE OF SUNSET CEREMONY (NAVAL)

11. The Sunset Ceremony is divided into eight phases as follows:
- a. Phase 1, The March On;
 - b. Phase 2, Beating Retreat and Tattoo;
 - c. Phase 3, The March Past;
 - d. Phase 4, Section Drill;
 - e. Phase 5, Feu de Joie;
 - f. Phase 6, The Evening Hymn;
 - g. Phase 7, Sunset; and
 - h. Phase 8, The March Off.

PERSONNEL

12. The personnel required for the ceremony are:
- a. Guard Commander – lieutenant (N) (captain);
 - b. Guard Officer – sub-lieutenant (N) (lieutenant);
 - c. Battery Officer – chief petty officer, second class (master warrant officer);
 - d. Guides – two petty officers, first class (warrant officers);
 - e. Gun Commanders – two petty officers, second class (sergeants);
 - f. Guard – 48 leading seaman/able seaman (corporals/privates);
 - g. Gun Crews – maximum 32 per gun and minimum 20 per gun (if guns are in position throughout the ceremony, five members per gun are required as a firing party);
 - h. Bands – one brass-reed band and one bugle band; and
 - i. Signalman – one able seaman (private).

PHASE 1: THE MARCH ON

13. As the time approaches for units to march onto the parade ground, the bands, guard and gun crews shall be ordered to attention and the guard shall be ordered to shoulder arms. At the appointed time, the brass-reed band shall play a musical fanfare. Upon completion of the fanfare, the guard commander shall order **GUARD, BANDS AND GUN CREWS, BY THE RIGHT (LEFT), QUICK – MARCH.**

14. Just before or immediately after wheeling into the parade ground entrance, depending upon the direction of their approach to the parade ground, the guides will position themselves so that they are one pace in front and one pace in rear of the rear rank.

15. Upon wheeling into the entrance from the left flank of the parade ground, the No. 2 Gun Crew shall step out until they reach a position three paces to the left of No. 1 Gun Crew, when they shall resume a normal pace (see Figure 12-4-1).
16. After entering the parade ground, the bands shall lead the procession by the most direct route to where the guard is required to halt. At this position, the band shall wheel right and proceed directly towards the dais. They will countermarch in front of the dais, proceed back towards the guard, countermarch once again in front of the guard and halt.
17. On reaching their designated position in front of the dais, the guard shall mark time and, on the bass drummer's signal, halt, turn to face the dais, and dress by the centre, observing a standard pause between all movements. On a signal from the front rank man of the centre file, each division shall turn their head and eyes to the front in succession from the centre.
18. After halting and observing a standard pause, the guard commander shall step off and position himself three paces to the rear of the third file from the left. Similarly, and in time with the guard commander, the guard officer shall position himself three paces in rear of the third file from the right.
19. Approaching the guard, both gun crews shall wheel half right, proceeding on a route which will bring them to a position in front of the guard. Upon reaching a position in front and on the right of the guard, they shall wheel half left to parallel the front rank of the guard and, upon reaching a position opposite the centre of the right division of the guard, the No. 1 Gun Crew shall wheel right, stepping short. The No. 2 Gun Crew shall proceed to a position opposite the centre of the left division of the guard and wheel right. When the No. 2 Gun Crew arrives in line with the No. 1 Gun Crew, the No. 1 Gun Crew shall resume a normal pace. Upon reaching a position halfway between the guard and the dais, the No. 1 Gun Crew shall wheel half right and the No. 2 Gun Crew half left. Both crews shall continue to their respective corners of the parade ground, wheel the guns into the previously determined position for firing, mark time and on the bass drummer's signal, HALT.

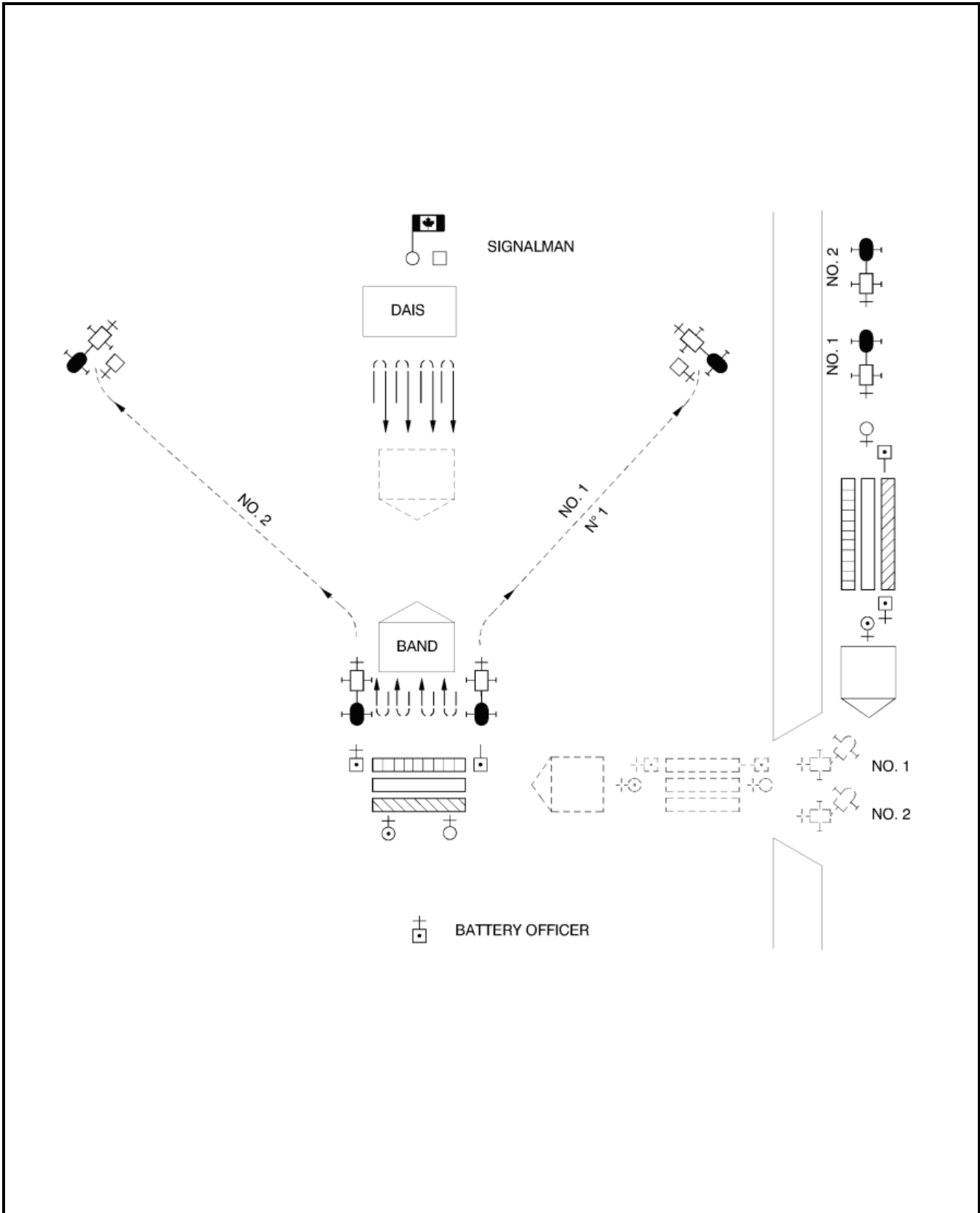

Figure 12-4- 1 Sunset Ceremony – Phase 1: The March On

20. As the gun crews wheel half right and half left towards their respective corners of the parade ground, the battery officer shall move to his position in centre rear of the guard, at a predetermined distance. The battery officer shall be positioned where both crews can view his visual signals (see Section 5, paragraph 30).

PHASE 2: BEATING RETREAT AND TATTOO

21. When the bands halt, one of the guns shall fire "The Evening Gun" as the signal to commence the Tattoo.

22. The drum major and the drum section of the bugle band step off in quick time, advance 10 paces and countermarch (see Figure 12-4-2). They march back through the bands, breaking into the slow march. When the drum major and drummers have passed through the bands, they countermarch once again and break into the quick march.

23. After the drummers break into the quick march, the bugle section of the bugle band step off, arriving in line in front of the drummers and one pace in front of the drum major. At a given signal, the drum major, drummers and buglers halt. The buglers observe a standard pause, incline inwards and play "First Post" (see Figure 12-4-3).

PHASE 3: THE MARCH PAST

24. On completion of the "First Post", the guard commander orders GUARD, MOVE TO THE LEFT IN THREES, LEFT – TURN; and GUARD AND BAND, QUICK – MARCH.

25. The guard and band step off together, the buglers countermarching to resume their original position within the band. The band proceeds directly toward the dais (Figure 12-4-4) to Point A, where it wheels right, marches to Point B and again wheels right. Upon reaching Point C, the band shall wheel right and proceed directly toward the guard. Concurrently, the guard shall march to Point D, wheel right and proceed to Point E. As the guard wheels at Point D, the guides shall assume positions one pace in front and one pace in rear of the left rank. At Point E, the guard wheels right to march through the ranks of the band at Point F.

26. The distance along the route A, B, C, F, at Figure 12-4-4 must be equal to the distance marched by the guard along route D, E, F, so that the guard will pass through the ranks of the band directly in front of the dais.

27. After the guard has passed through the band, the band shall countermarch and follow the route of the guard. At Point C, the guard shall wheel left and proceed to the march past line. As the right guide reaches the march past line, the guard commander shall order GUARD, ADVANCE, LEFT – TURN, and after completing the turn, BY THE – RIGHT. The band wheels left at the march past line, dressing on the centre of the guard.

28. Upon reaching Flag C (Figure 12-4-5, see also Figure 9-2-1 for the standard points along the march past line) the guard commander shall order GUARD, EYES – RIGHT, and when the guard has cleared Flag D, GUARD, EYES – FRONT.

29. On completion of the march past and on arriving at Flag F, the guard commander shall order GUARD, MOVE TO THE RIGHT IN COLUMN OF THREES, RIGHT – TURN; LEFT – WHEEL; and LEFT – WHEEL. When in line with its original position, the guard shall wheel left and march to its original position, where the guard commander shall order GUARD – HALT; and GUARD, ADVANCE, LEFT – TURN. On completion of the turn, the guard shall dress automatically towards the centre, with the head and eyes turned to the front as detailed in paragraph 17. The band takes up a position in rear of the guard facing the dais.

PHASE 4: SECTION DRILL

30. From his position within the band, the side drummer shall give a drum roll which will be followed by a single beat of the bass drum.

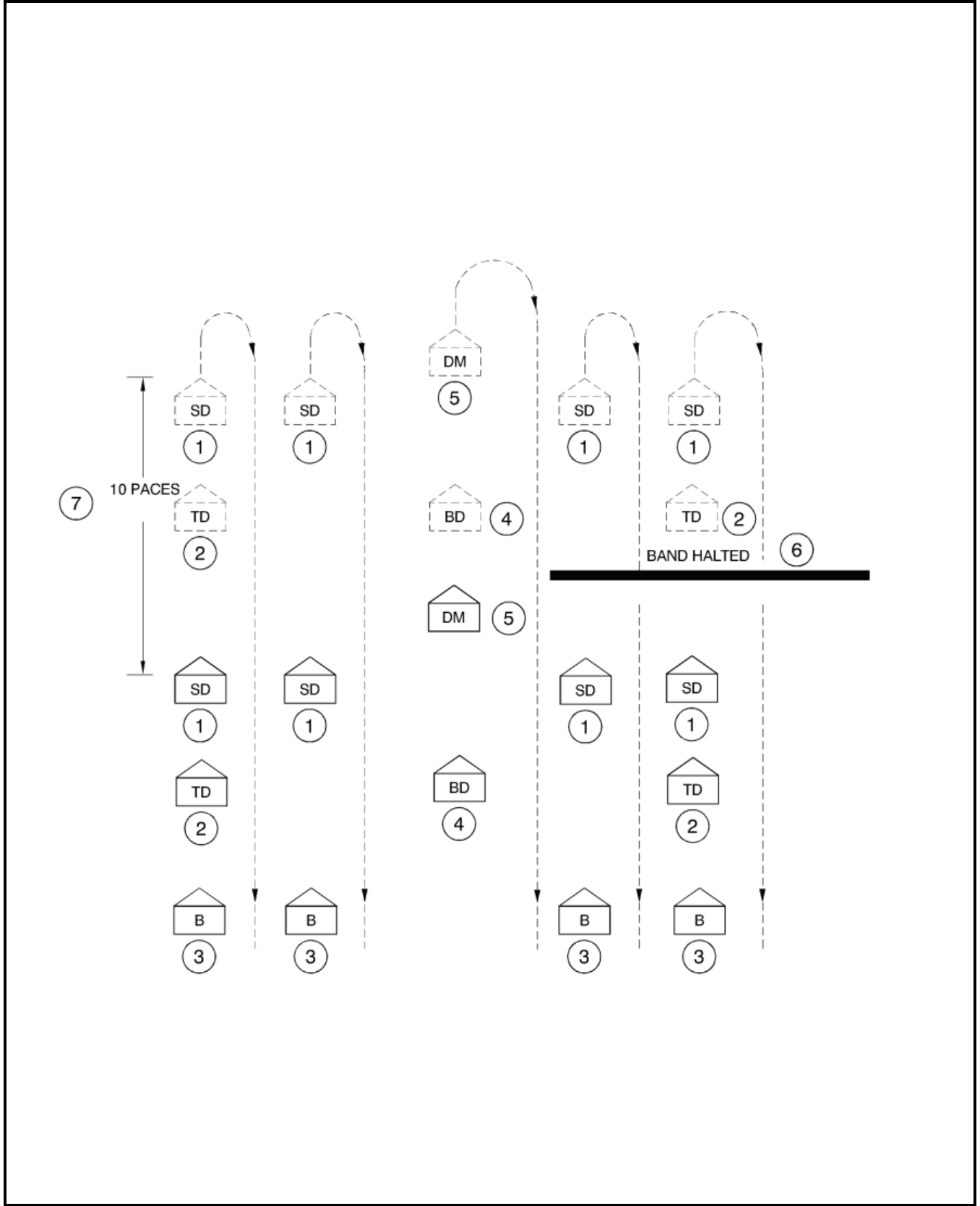

Figure 12-4- 2 Sunset Ceremony – Phase 2: The Drums

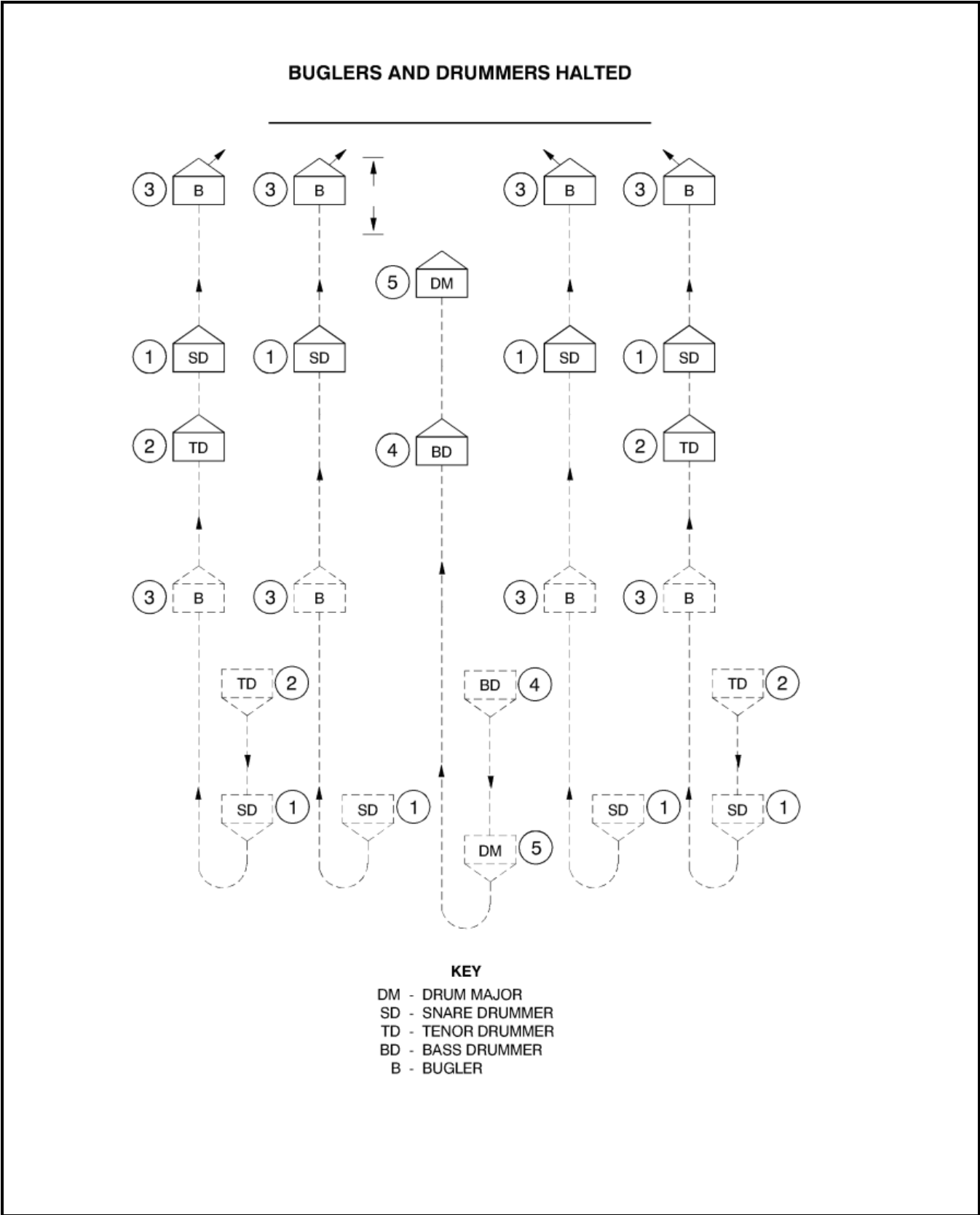

Figure 12-4-3 Sunset Ceremony – Phase 2: The Buglers

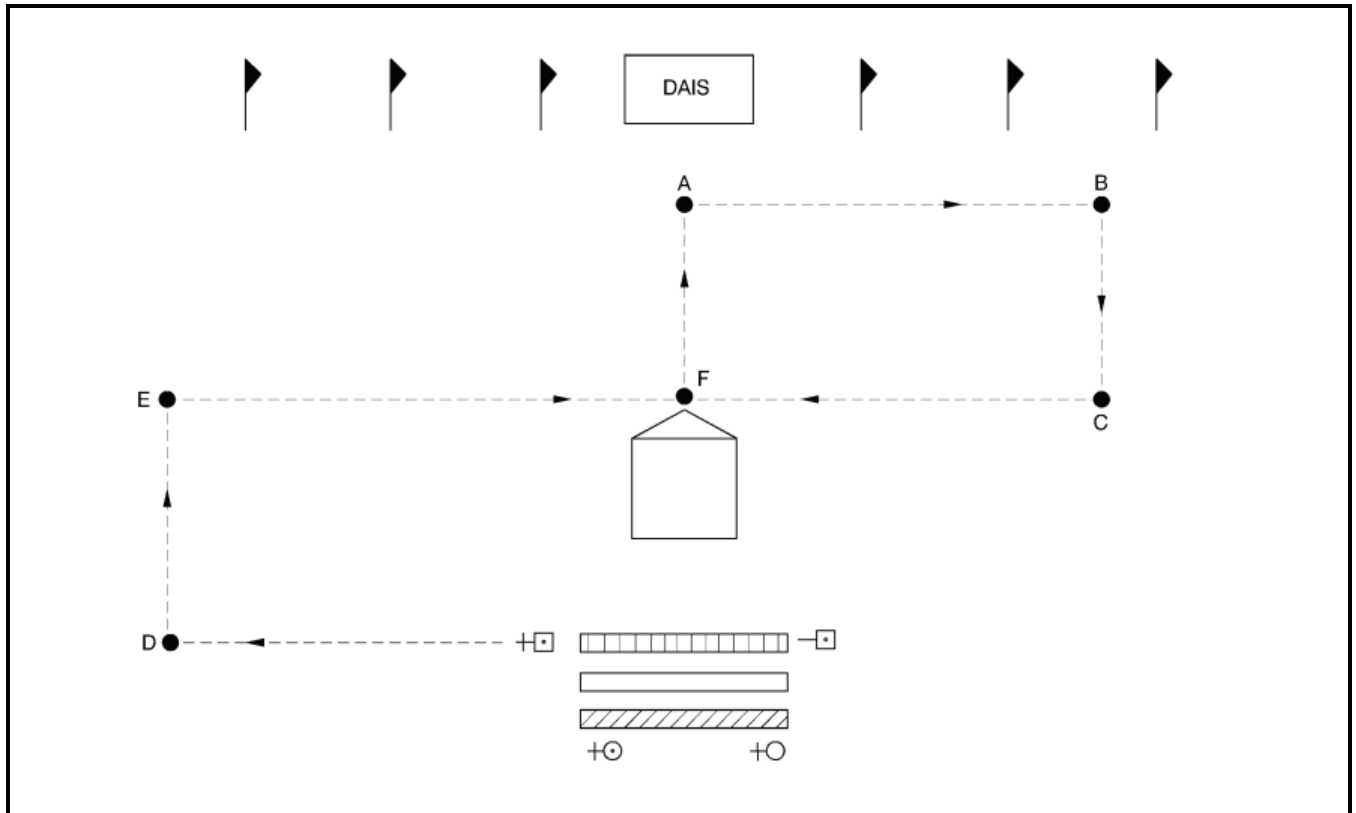

Figure 12-4- 4 Sunset Ceremony – Phase 3-1

31. Acting on the single beat of the bass drum, the guard shall form two divisions, the right division turning right and the left division turning left. After completing the turn and observing a standard pause, both divisions step off together in quick time and march 20 paces. On the twentieth pace, both divisions turn to face the dais, the left division commencing their right turn with the right foot forward and on the ground. As both divisions turn, they shall mark time four paces, commencing with the first left foot pace after turning. During the four mark time paces, both divisions will form two ranks. This is accomplished by the centre rank taking a half pace left on the first mark time pace, the odd numbers then taking two half paces forward while the even numbers take two half paces back on the second and third mark time paces. The whole of both divisions complete the fourth mark time pace with the right foot and step off together in quick time on the fifth pace (left foot). Both divisions then will advance toward the dais in quick time for six paces before changing into slow time on the seventh pace (left foot). Both divisions continue to advance in slow time for six further paces and, on the next left foot, commence to fix bayonets at the shoulder, on the march, whilst marching a further 20 paces in slow time (see Section 5, paragraph 25). On the first left foot following the twentieth pace, both divisions change into quick time and march forward 16 additional paces, commencing four mark time paces on the first left foot following the sixteenth pace. On the completion of the fourth mark time pace, both divisions simultaneously shall turn inwards, taking two mark time paces to complete the turn. After taking two further mark time paces, both divisions march towards each other, stepping off with the left foot and, when both divisions meet in the centre, they shall halt on a bass drum signal. After halting, both divisions shall observe a standard pause, turn to face the dais, observe another standard pause and dress automatically by the centre. On a signal from the front rank man of the centre file, each file shall turn its head and eyes to the front in succession from the centre.

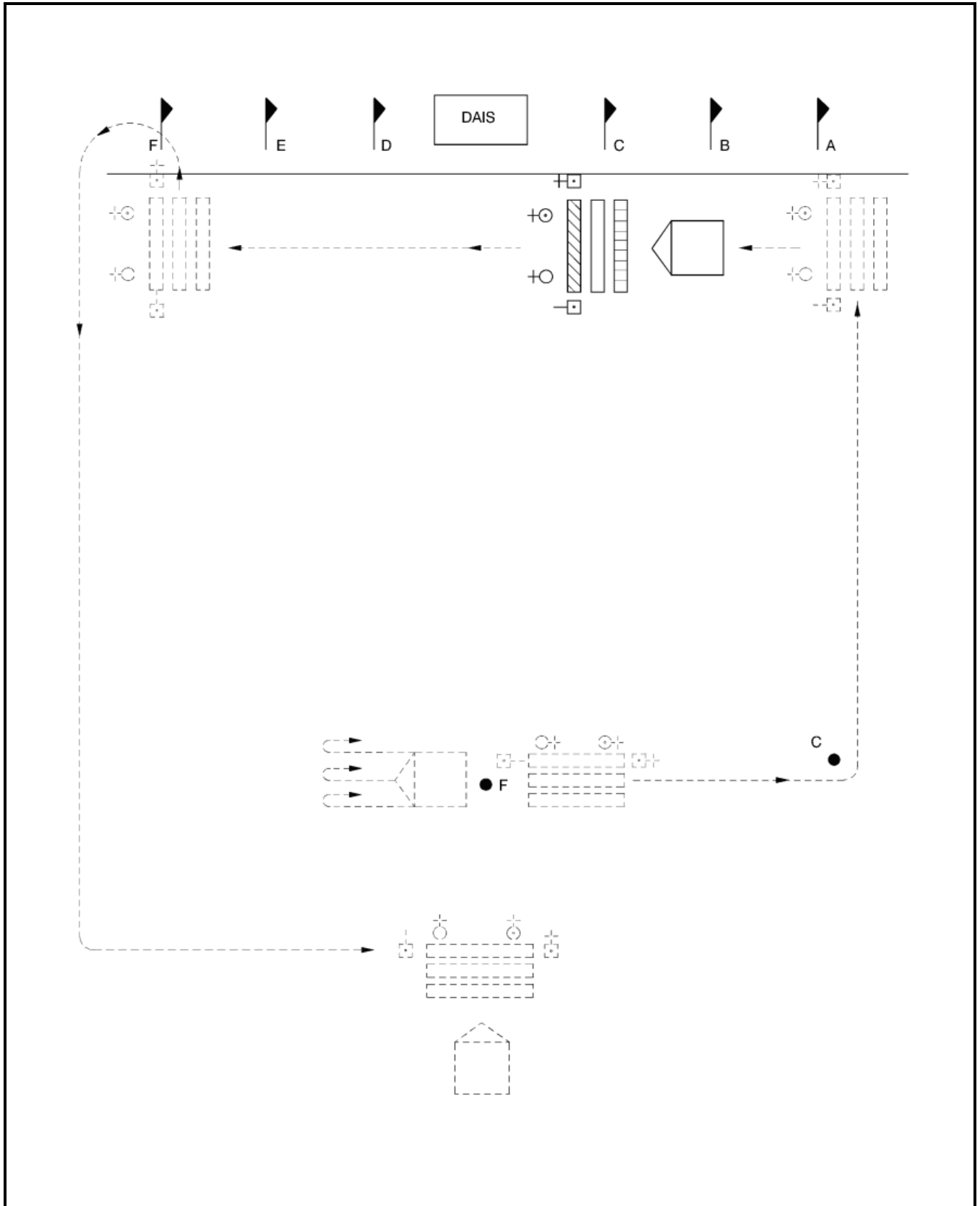

Figure 12-4- 5 Sunset Ceremony – Phase 3-2

32. As the guard changes into quick time after fixing bayonets, the band will step off in quick time and move straight forward towards the dais, coming to a halt on the drum major's signal, in rear of the rejoined guard.

PHASE 5: FEU DE JOIE

33. The guard commander gives the orders in Table 12-4-1:

No. N°	Command	Action
1	GUARD, ORDER – ARMS	The guard orders arms.
2	GUARD, OPEN ORDER – MARCH	The rear rank takes three half paces to the rear.
3	GUARD, SHOULDER DRESSING, RIGHT – DRESS	The guard dresses to the right, taking up shoulder dressing intervals between files.
4	GUARD WILL UNFIX BAYONETS, UN – FIX	The guard unfixes bayonets.
5	GUARD, BAYO – NETS	The guard sheathes bayonets.
6	GUARD, ATTEN – TION	The guard assumes the attention position.

Table 12-4- 1 Preparation for the Feu de Joie

34. The Feu de Joie is fired as detailed in Chapter 9, Table 9-6-1, items 4 to 16 inclusive.

PHASE 6: THE EVENING HYMN

35. After completion of the Feu de Joie, the guard shall be stood at ease.

36. The brass-reed band plays an appropriate evening hymn.

37. On completion of the hymn, the guard commander orders GUARD, ATTEN – TION; GUARD WILL FIX BAYONETS – FIX; GUARD, BAYONETS; and GUARD, ATTEN – TION.

PHASE 7: SUNSET

38. After the guard has assumed the attention position, the signalman, from his position at the base of the flag pole, shall report to the guard commander ONE MINUTE TO SUNSET, SIR, and then prepare to lower the National Flag.

39. The guard commander shall then order GUARD, SHOULDER – ARMS.

40. On completion of the shoulder arms, the bugler sounds "Alert" and the band commences to play the "Orchestrated Sunset". On the seventh measure of music, the bass drummer accentuates the beat on his drum. This is the signal for the guard commander to order GUARD, GENERAL SALUTE, PRESENT – ARMS.

41. On the last movement of the present arms, the No. 1 gun commander fires one gun and the signalman commences to lower the National Flag. On completion of the "Orchestrated Sunset" the band plays the National Anthem, "O Canada" (see also Chapter 7 to A-AD -200-000/AG-000, The Honours, Flags and Heritage Structure of the CF, soon to become A-DH-200-000/AG-000; The Heritage Structure of the CAF). The signalman shall time the lowering of the National Flag so that it is completed on the last note of the "Orchestrated Sunset".

PHASE 8: THE MARCH OFF

42. At the conclusion of the Anthem, the guard commander orders GUARD, SHOULDER – ARMS.

43. On the last movement of the shoulder, the battery officer fires both guns. The bugler sounds "Carry On".

44. The guard commander orders GUARD, CLOSE ORDER – MARCH; and GUARD, REFORM THREE – RANKS.

45. On the command CLOSE ORDER – MARCH, the gun crews limber up and form the order of march (see Annex A).

46. The guard commander then orders GUARD, MOVE TO THE RIGHT IN THREES, RIGHT – TURN, and GUARD, BANDS AND GUN CREWS, QUICK – MARCH. The procession shall move off the parade ground in the following order of march: the guard, the bands, No. 1 and No. 2 Gun Crews, one behind the other. They shall march to the dispersal area, where the guard shall unfix bayonets prior to the units being dismissed.

SECTION 5

THE CEREMONY OF THE FLAGS

INTRODUCTION

1. The Ceremony of the Flag is a display originally developed by the Royal Canadian Navy out of the Sunset Ceremony after the introduction of the Canadian National Flag in 1965. Because of this origin, naval ranks and appointments are used in this section, with equivalents noted in paragraph 11.
2. The theme of the ceremony is distinctively Canadian. The National Flag of Canada, the flags of each province and territory are paraded together.
3. The ceremony is designed to be held during the day or at sunset; in the latter case, an additional phase is completed.

GENERAL

4. The ideal parade area should be 60 by 120 metres. The minimum requirement to perform the ceremony is 30 by 60 metres.
5. Units participating in the ceremony shall form in an assembly area removed from the view of spectators situated around the parade ground. They shall form up in the following order of march: the band, the guard, and the No. 1 and No. 2 Gun Crews, one behind the other. The national and provincial/territorial flags shall be positioned at a six-pace interval abreast of the left flank of the guard, in the following order from front to rear:
 - a. Nunavut Territory;
 - b. Yukon Territory;
 - c. the Province of Alberta;
 - d. the Province of Prince Edward Island;
 - e. the Province of Manitoba;
 - f. the Province of Nova Scotia;
 - g. the Province of Ontario;
 - h. the senior escort to the National Flag;
 - i. the National Flag of Canada;
 - j. the junior escort to the National Flag;
 - k. the Province of Quebec;
 - l. the Province of New Brunswick;
 - m. the Province of British Columbia;
 - n. the Province of Saskatchewan;
 - o. the Province of Newfoundland; and
 - p. The Northwest Territories.

6. Prior to marching onto the parade ground, the guard shall be numbered in two divisions so that centre rank personnel of each division knows the direction in which to move in order to form two ranks in Phase 2 of the ceremony. The centre file shall also be identified so that guard members know the file on which to dress when required to dress by the centre.
7. The guard shall march on in column of route, the guard commander positioning himself two paces in front and the guard officer, two paces in rear of the centre file.
8. It is preferable that the entrance to the parade ground be situated to the left of the dais (when facing the dais). Should the entrance be situated to the right of the dais, the guard shall be marched on in reverse order, i.e., left flank leading, so that it will be positioned properly when halted.
9. The positioning of the guns and the direction of fire must be determined prior to the ceremony, bearing in mind the proximity of spectators, guard and band.
10. In order to facilitate the precision and exactness that this ceremony requires, the parade ground should be suitably marked to indicate where the guard and band will perform movements on the march.

PERSONNEL

11. The personnel required to perform the ceremony are:
 - a. Guard Commander – lieutenant (N) (captain);
 - b. Guard Officer – sub-lieutenant (N) (lieutenant);
 - c. National Flag Bearer – sub-lieutenant (N) (lieutenant);
 - d. Battery Officer – chief petty officer, second class (master warrant officer);
 - e. Guides – two petty officers, first class (warrant officers);
 - f. National Flag Escort – two leading seaman/able seaman (corporals/privates);
 - g. Gun Commanders – two petty officers, second class (sergeants);
 - h. Provincial and Territorial Flag Bearers – 13 petty officers, second class (sergeants);
 - i. Guard – 48 leading seaman/able seaman (corporals/privates);
 - j. Gun Crews – maximum 32 per gun and minimum 20 per gun (if guns are in position throughout the ceremony, five members per gun are required as a firing party);
 - k. Bands – one brass-reed band or one bugle band; and
 - l. Signalman – one able seaman (private) (if ceremony is performed at sunset).

SEQUENCE OF THE CEREMONY OF THE FLAGS

12. The Ceremony of the Flags is divided into six phases as follows:
 - a. Phase 1, The March On;
 - b. Phase 2, Section Drill;
 - c. Phase 3, Feu de Joie;
 - d. Phase 4, Salute to the Flags;

- e. Phase 5, The March Past; and
- f. Phase 6, Sunset (if appropriate).

PHASE 1: THE MARCH ON

13. As the time approaches to march onto the parade ground, the band, guard, flag bearers and gun crews shall be ordered to attention and the guard shall be ordered to shoulder arms. At the appointed time, the band shall play a musical fanfare. Upon completion of the fanfare, the guard commander shall order GUARD, BAND, FLAG BEARERS AND GUN CREWS, BY THE LEFT (RIGHT), QUICK – MARCH.

14. Throughout the ceremony, the guides shall position themselves on the directing flank, changing position as required just before or immediately after wheeling.

15. Upon wheeling into the entrance of the parade ground, the No. 2 Gun Crew shall step out until they reach a position three paces to the left of No. 1 Gun Crew, when they shall resume a normal pace.

16. After entering the parade ground, the band shall lead the procession by the most direct route to where the guard and flag bearers are required to halt. At this position, the band shall wheel left and proceed directly towards the dais. At the march past line the band will wheel right and proceed to Flag B where it shall change into slow time, immediately countermarch and proceed along the march past line to Flag E, with the drum major and band director saluting the reviewing officer or dignitary as they pass. At Flag E, the band shall change into quick time and immediately countermarch, proceeding back on the march past line to a position in front of the dais where the band shall wheel right. Nearing the flag bearers, the band shall countermarch and halt in a position in front and centre of the flag bearers (see Figure 12-5-1).

17. As the guard and flag bearers enter the parade ground, the flag bearers shall maintain themselves at a six-pace interval from the left flank of the guard and in individual alignment with the appropriate file of the guard. On reaching their position in front of the dais, the guard and flag bearers shall mark time and, acting on the bass drummer's signal, halt, turn to face the dais, and dress by the centre, observing a standard pause between movements. While the guard and the remainder of the flag bearers are dressing, the National Flag and Escort shall take up a position, three paces forward and in the centre of the provincial flags (see Figure 12-5-1).

18. After ensuring that the National Flag is in position, the front rank member of the centre file of the guard will give a vocal signal and each division of the guard and flag bearers will turn their head and eyes to the front in succession from the centre.

19. After halting and observing a standard pause, the guard commander shall step off and position himself three paces in front of the third file from the right. Similarly, and in time with the guard commander, the guard officer shall position himself three paces in front of the third file from the left.

20. Approaching the guard, both gun crews shall wheel half left, proceeding on a route which will bring them to a position in front of the flag bearers. Upon reaching a position in front and on the left of the flag bearers, they shall wheel half right to parallel the flag bearers and, upon reaching a position opposite the centre of the left half of the flag bearers, the No. 2 Gun Crew shall wheel left, stepping short. The No. 1 Gun Crew shall proceed to a position opposite the centre of the right half of the flag bearers and wheel left. When the No. 1 Gun Crew arrives in line with the No. 2 Gun Crew, No. 2 Gun Crew shall resume a normal pace. Upon reaching a position half-way between the flag bearers and the dais, the No. 1 Gun Crew shall wheel half right and the No. 2 Gun Crew half left. Both crews shall continue to their respective corners of the parade ground, wheel the guns into positions previously determined for firing, mark time, and on the bass drummer's signal, HALT.

21. As the gun crews wheel half right and half left towards their respective corners of the parade ground, the battery officer shall move to his position in the centre rear of the guard, at a predetermined distance. The battery officer shall be positioned where both gun crews can view his visual signals.

PHASE 2: SECTION DRILL

22. From his position within the band, the side drummer shall give a drum roll which will be followed by a single beat of the bass drum.

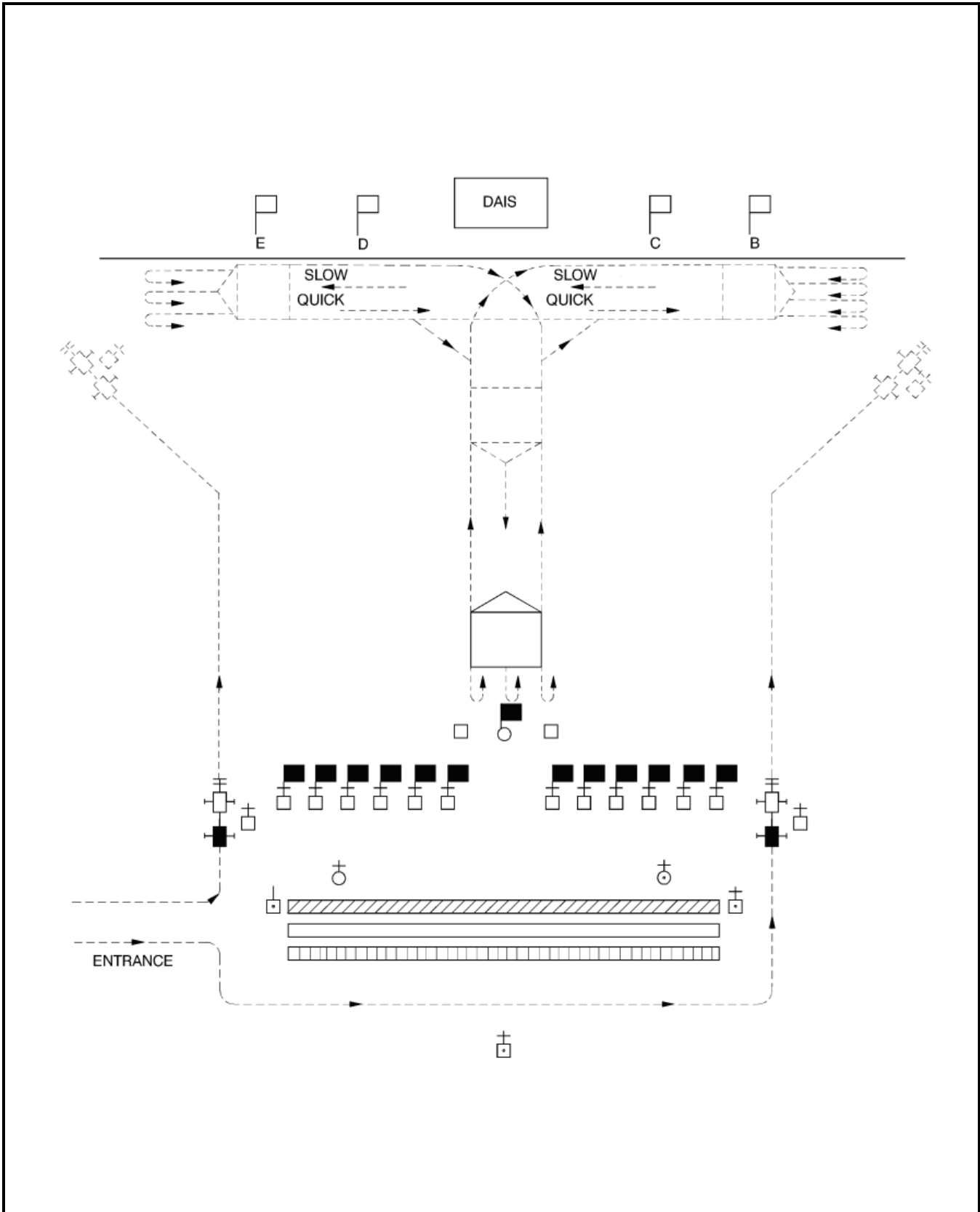

Figure 12-5- 1 Ceremony of the Flags – Phase 1

23. Acting on the single beat of the bass drum, the guard shall form two divisions, the right division turning right and the left division turning left. After completing the turn and observing a standard pause, both divisions step off together in quick time and march 20 paces. On the twentieth pace, both divisions turn to face the dais, the left division commencing their right turn with the right foot forward and on the ground. As both divisions turn, they shall mark time four paces, commencing with the first left foot pace after turning. During the four mark time paces, both divisions will form two ranks; this is accomplished by the centre rank taking a half pace left on the first mark time pace, the odd numbers then taking two half paces forward while the even numbers take two half paces back on the second and third mark time paces. The whole of both divisions complete the fourth mark time pace with the right foot and step off together in quick time on the fifth pace (left foot). Both divisions then will advance toward the dais in quick time for six paces before changing into slow time on the seventh pace (left foot). Both divisions continue to advance in slow time for six further paces and, on the next left foot, commence to fix bayonets at the shoulder, on the march, whilst marching a further 20 paces in slow time (see paragraphs 22 to 24). On the first left foot following the twentieth pace, both divisions change into quick time and march forward 16 additional paces, commencing four mark time paces on the first left foot following the sixteenth pace. On the completion of the fourth mark time pace, both divisions simultaneously shall turn inwards, taking two mark time paces to complete the turn. After taking two further mark time paces, both divisions march towards each other, stepping off with the left foot and, when both divisions meet in the centre, they shall halt on a bass drum signal. After halting, both divisions shall observe a standard pause, turn to face the dais, observe another standard pause and dress automatically by the centre. On a signal from the front rank man of the centre file, each file shall turn its head and eyes to the front in succession from the centre (see Figure 12-5-2).

24. The provincial flag bearers shall turn right and left with their respective divisions, carry out the same foot drill as their respective division, and maintain their position, six paces in front of the front rank of their division throughout the drill. The National Flag bearer and escorts shall stand fast until both divisions of the guard have advanced to face the dais and formed two ranks. They shall then step off with the guard, changing into slow and quick time with the guard, marking time when they have completed the 16 paces in quick time and halting with the guard on the bass drum signal. The National Flag bearer and escort shall maintain their relative position nine paces in front of the front rank of the guard (three paces in front of the provincial flag bearers) throughout the foot drill.

FIXING BAYONETS ON THE MARCH

25. On the seventh pace of slow march:

- a. **One.** Grasp the bayonet handle with the left hand, with the thumb over the ring of the bayonet, the back of the hand to the body and the fingers around the handle. Rotate the scabbard counter clockwise. Hold the scabbard point upward in line with the left shoulder blade. The fingers are to be held together in an all-around grasp;
- b. **Two.** Withdraw the bayonet from the scabbard to the full extent of the left arm keeping the bayonet behind the back;
- c. **Three.** Bring the bayonet to a position in front of the body, arm extended to an angle of 45 degrees in line with the right shoulder. Force the wrist down so as to make the arm straight;
- d. **Four.** Turn the head to the right and look directly at the muzzle. Simultaneously, bend the left elbow and align the bayonet with the bayonet stud and force the rifle butt one foot to the rear of the right hip;
- e. **Five.** Fix the bayonet to the bayonet stud, retaining an all-round grip of the bayonet handle with the left hand; and
- f. **Six.** Cut the left hand to the side. Simultaneously, force the rifle to the position of the shoulder and turn the head to the front.

26. Each movement is executed as the left foot is forward and on the ground and on the heavy beat of the drum.

PHASE 3: FEU DE JOIE

27. The guard commander shall give the orders in Table 12-5-1.

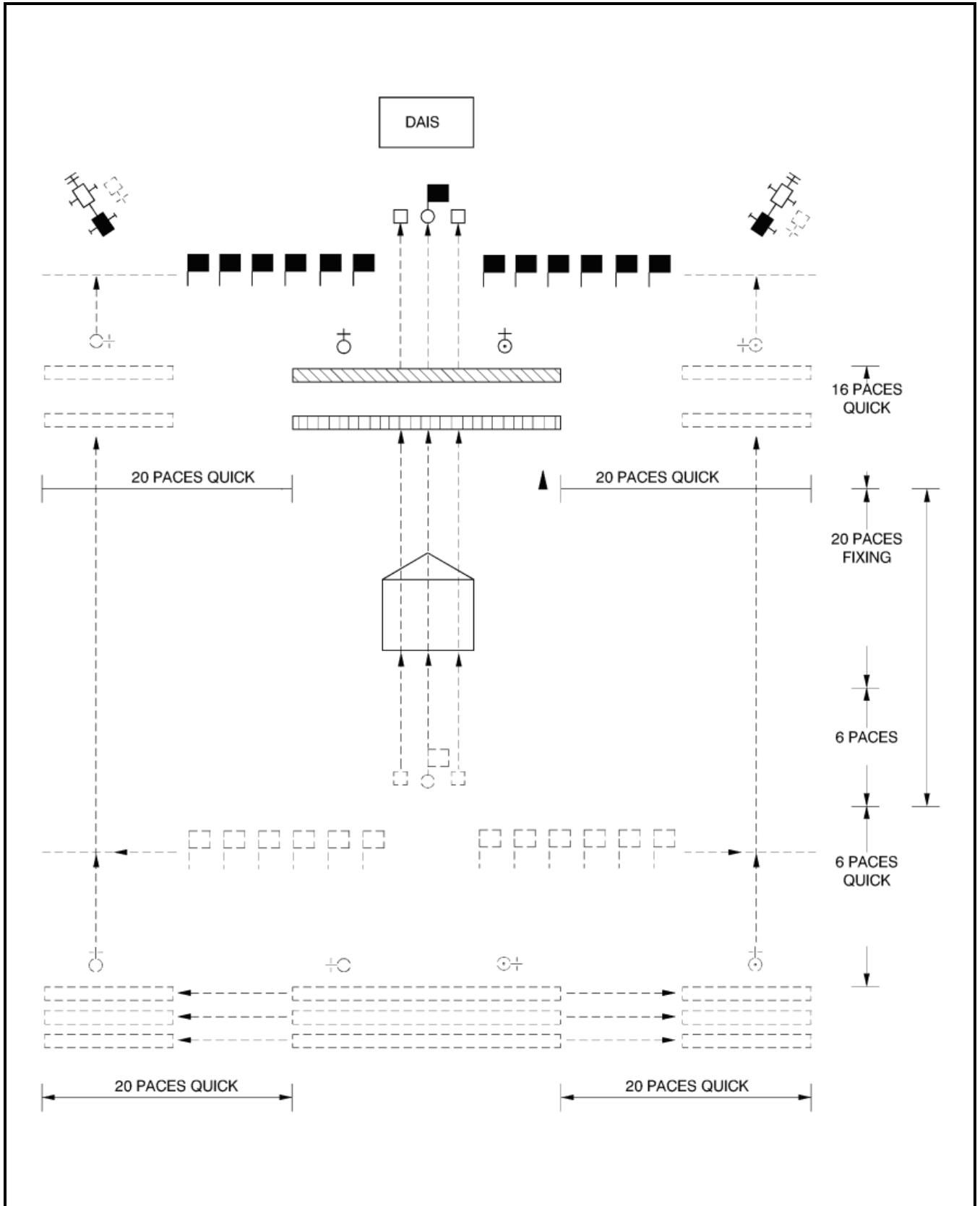

Figure 12-5- 2 Ceremony of the Flags – Phase 2

PHASE 4: SALUTE TO THE FLAGS

28. On the commands GUARD, SHOULDER – ARMS; and GUARD, GENERAL SALUTE, PRESENT – ARMS, the guard acts as ordered. On the completion of the last movement of the present arms, the provincial flag bearers shall observe a standard pause, turn outwards, the six flags in front of the right division turning right and those in front of the left division turning left. After observing a standard pause, both step off at the slow march, executing two successive right and left wheels to move between the front and rear ranks of the guard. When passing through the ranks, the six flags that previously stood in front of the left division shall pass those who stood in front of the right division on their left. On reaching the right and left flanks of the guard, they shall wheel right and left once again. Abreast of their original line, they shall wheel inward and halt, each occupying the other's former position. After observing a standard pause, the provincial flag bearers simultaneously shall turn to face the front (see Figure 12-5-3).

29. As the provincial flag bearers turn outwards, the National Flag bearer and the escorts shall step off in quick time, immediately wheeling left through full 90 degrees, then halting. The National Flag party and the provincial flag bearers then shall step off together in slow time. The National Flag party shall proceed towards the left flank of the guard for 20 paces and, on the twentieth pace, execute a right about turn, proceed across the front of the guard and, on the fifty-eighth pace, execute a left about turn to proceed back to the position from whence they commenced the slow march, halting on the eighty-fourth pace. As the provincial flag bearers turn to face their front, the National Flag party shall turn about, wheel right into their original position and halt. After observing a standard pause, they shall turn about to face the front. The paces executed during the two about turns by the National Flag party shall be counted in the 84 paces marched in slow time, the whole of the trooping of all flags being performed to a count of 84 paces.

30. The guns shall fire, on order of the battery officer, on every fourth pace until 21 guns have been fired. The battery officer shall signal the order to fire by adopting the recover position from the carry, then pointing his sword at the gun required to fire. When pointing the sword, the right arm shall be fully extended, with the sword and arm being held parallel to the ground. Upon the gun being fired, the battery officer shall resume the recover position prior to signalling the second gun to fire. In the event of a misfire, the battery officer shall resume the recover position and then point his sword at the alternate gun. The guns should be rotated for each round fired.

31. The band shall commence to play the Royal Anthem, "God Save The Queen", and the National Anthem "O Canada", as the flag bearers step off. The guard remains at the present throughout.

32. Upon completion of the National Anthem, the guard commander shall order GUARD, SHOULDER – ARMS; and GUARD, ORDER – ARMS and the guard shall act as ordered.

PHASE 5: THE MARCH PAST

33. On the command GUARD, CLOSE ORDER – MARCH, the guard acts as ordered, the limber box lids are slammed down on the order GUARD and MARCH, is the order for the gun crews to limber up (see Annex A).

34. On the command GUARD, FORM THREE – RANKS, the guard acts as ordered. Automatic dressing is not carried out because the common frontage with the flags should not change. On the second movement of the form threes, the even numbers in the front rank, i.e., those on the left of the man who moved to form the centre rank, take a side pace to the right and similarly, the even numbers in the rear rank take a side pace to the left.

35. The guard commander then shall order GUARD, SHOULDER – ARMS; and GUARD, OUTWARDS – TURN. On the executive order TURN, the guard divisions shall turn outwards and the provincial flag bearers shall turn inwards; the National Flag bearer and escorts turn right.

No.	Command	Action	Remarks
1	GUARD, ORDER – ARMS	The guard orders arms.	
2	GUARD, OPEN ORDER – MARCH	The rear rank takes three half paces to the rear.	
3	GUARD, SHOULDER DRESSING, RIGHT – DRESS	The guard dresses to the right taking up shoulder dressing.	
4	GUARD, EYES – FRONT	All heads and eyes are turned to the front.	
5	GUARD WILL UNFIX BAYONETS, UN – FIX	The guard shall unfix bayonets.	
6	GUARD, BAYO – NETS	The guard sheathe their bayonets.	
7	GUARD, ATTEN – TION	The guard assumes the attention position.	
8	GUARD, WITH BLANK CARTRIDGES, STANDING – LOAD		
9	GUARD, PRESENT	The rifles are brought to the right shoulder at an angle of 30 degrees.	Prior to this command being given, the guard officers shall step forward three half paces.
10			The drummers give a drum roll and the battery officer fires one gun. When the gun fires, the right guide fires his rifle. The remainder of the guard fire consecutively from right to the left in the front rank and left to right in the rear rank.
11	GUARD, RE – LOAD	The guard reload their rifles.	The sequence, load, present, drum roll, field gun fire, and rifle fire is carried out three times.
12	GUARD, MAKE – SAFE	The guard return to the standing load position and unload their rifles.	
13	GUARD, ORDER – ARMS	The guard order arms, from the examine position.	
14	GUARD WILL FIX BAYONETS – FIX	The guard withdraw their bayonets.	
15	GUARD, BAYO – NETS	The guard fix bayonets to their rifles.	
16	GUARD, ATTEN – TION	The guard assumes the attention position.	

Table 12-5-1 The Feu de Joie

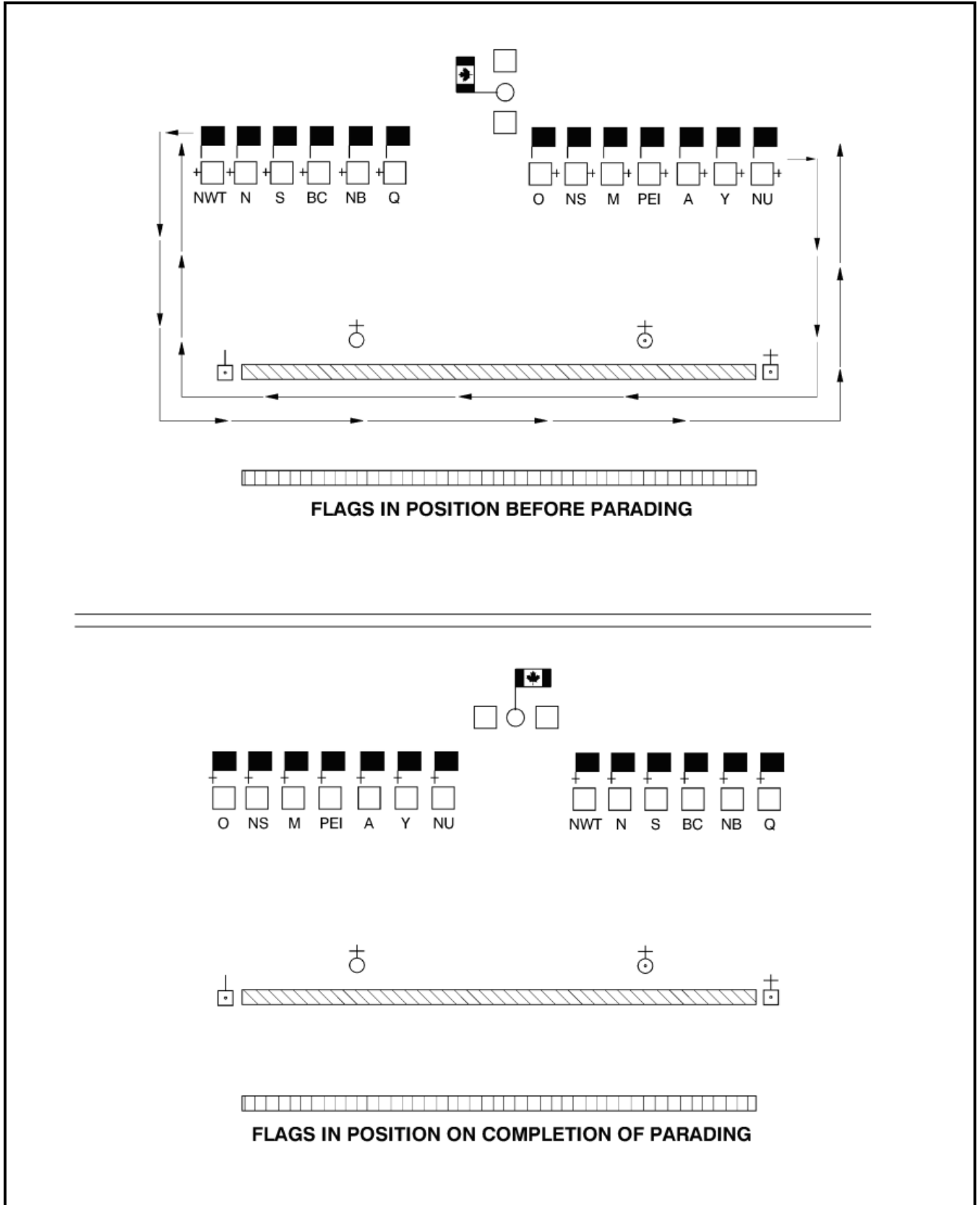

Figure 12-5- 3 Ceremony of the Flags – Phase 4

36. On the command GUARD, BAND AND GUN CREWS, QUICK – MARCH, the right division of the guard wheels right, the left division wheels left, the provincial flag bearers wheel right and left away from the dais. The National Flag bearer and escorts wheel right and form in the centre of the file of provincial flag bearers, and the flag bearers march through the band. After the flag bearers have passed through the band, the band countermarches, stepping off in quick time. The gun crews shall step off, from their positions at the corners of the parade square, angle across the parade square and fall in for the march past, positioned in rear of the band. As the procession passes the battery officer, he shall fall in between the gun crews at the head of the gun battery. The guard commander and guard officer shall adopt a position three paces from and abreast of the centre of their respective division of the guard. The guard officer, during the first left wheel executed by the left division, shall adopt a position three paces from and abreast of the rear rank. Prior to the first left wheel executed by the left division, the left marker shall adopt a position one pace in front of the rear rank.

37. Upon reaching the march past line opposite Flag A (see Figure 9-2-1), each sub-unit commander shall order _____, ADVANCE, LEFT – TURN. On reaching Flag C, the sub-units shall be ordered, _____, EYES – RIGHT, and upon clearing Flag D _____, EYES – FRONT. On arrival at Flag F, each sub-unit commander shall order _____, MOVE TO THE RIGHT IN COLUMN OF ROUTE, RIGHT – TURN, followed by two successive left wheels.

38. The procession then shall be marched off the parade ground to the dispersal area where the guard shall unfix bayonets and all shall be dismissed.

SUNSET

39. If the lowering of the National Flag flown on a flagpole is to be performed at sunset with the ceremony of the flags, it shall follow Phase 5. Upon completion of the march past, each sub-unit shall return to its original position (see Figure 12-5-1) from where the guard commander shall give the orders in Table 12-5-2.

40. Upon completion of the sunset portion of the ceremony, the guard commander shall proceed as detailed in paragraph 38.

BAND MUSIC

41. Phase 1

- a. Fanfare – Played just prior to ceremony.
- b. March (Quick) – Played until cut off.
- c. March (Slow) – 16 bars.
- d. March (Quick) – Played until the band halts in front of guard.

42. Phase 2

- a. March (Quick) – Commence playing as the guard steps off (duration 30 paces).
- b. March (Slow) – The change from the quick to the slow is immediate (duration 38 paces).
- c. March (Quick) – This change is also immediate and can be the same quick march as the previous one. This march is played until both sections of the guard meet, at which time the halt is given on the bass drum at the end of a phase.

43. Phase 4

- a. March (Slow) – Begins as the flag bearers step off (duration 84 paces).
- b. The Royal Anthem, “God Save The Queen”.

c. The National Anthem, "O Canada".

No.	Command	Remarks
1	GUARD, ORDER – ARMS	
2	GUARD, STAND AT – EASE	Guard stands at ease and the flag bearers order flags and stand at ease.
3	GUARD, STAND – EASY	The whole parade, less the flag bearers, lowers their heads.
4		The band plays a hymn and the signalman reports "One minute to Sunset, Sir".
5	GUARD, ATTEN – TION	
6	GUARD, SHOULDER – ARMS	
7		The signalman reports "Sunset, Sir".
8	GENERAL SALUTE, PRESENT – ARMS	On the completion of the last movement of the present, one gun is fired. The band plays the "Orchestrated Sunset" and the National Anthem (see also Chapter 7 to A-AD-200-000/AG-000, The Honours, Flags and Heritage Structure of the CF, soon to be A-DH-200-000/AG-000, The Heritage Structure of the CAF). The National Flag flown from a flagpole is lowered during the playing of the "Orchestrated Sunset" and completed on the last note of that piece.
9	GUARD, SHOULDER – ARMS	
10	GUARD, ORDER – ARMS	

Table 12-5- 2 Ceremony of the Flags: Sunset

44. Phase 5

- a. March (Quick) – Preceded by a five-beat roll on the drums; band standing fast until flag bearers have marched through the band.
- b. Navy, Regimental, Air or Command Quick March – five-beat roll is given as the first section is turned into line to march past. This is played until all sections have marched past.
- c. March (Quick) – Played to take all sections off the field.

45. Sunset

- a. Evening Hymn.
- b. "Orchestrated Sunset" (Retreat).
- c. The National Anthem (see also Chapter 7, A-AD-200-000/AG-000, Honours, Flags and Heritage Structure of the CF (soon to become A-DH-200-000/AG-000; The Heritage Structure of the CAF)).

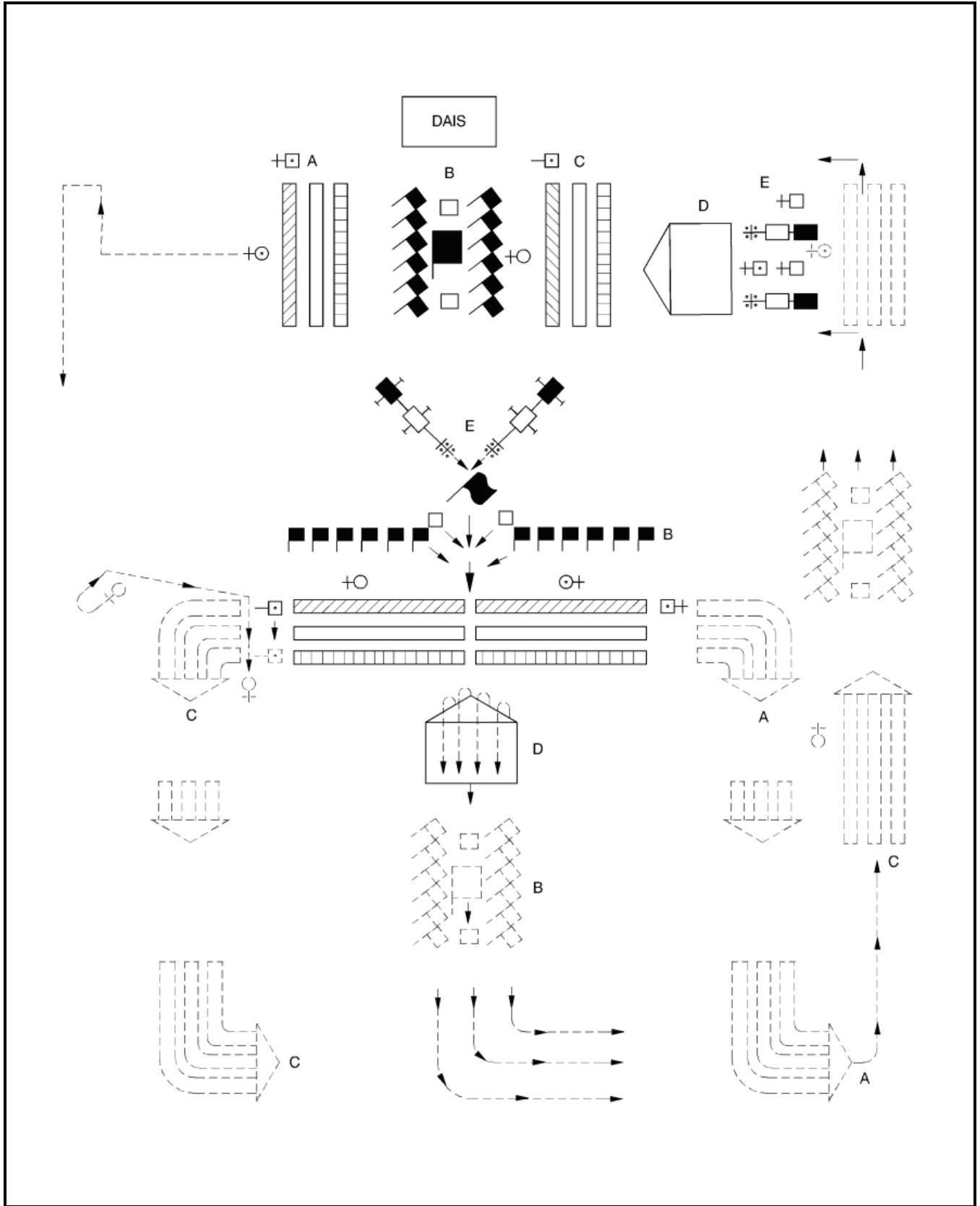

Figure 12-5- 4 Ceremony of the Flags – Phase 5

SECTION 6

SPECIAL OCCASIONS

GENERAL

1. Normal unit organization and planning suffices for routine parades and concerts. For special, complex occasions, such as elaborate tattoos and music festivals, a separate project staff must be established. This section provides guidance to assist with the technical advice to planning staffs in such a project's development.
2. The operational commander ordering the programme is responsible for appointing the show producer or programme director and forming the project staff. Unless the programme involves only a simple series of concert performances, the producer will usually be a line officer, with a senior Music Branch officer or Director of Music acting as a technical adviser and the programme's musical director.
3. Special occasions vary widely. Guidance for a range of examples are provided in the following references:
 - a. Sections 1 to 5 detail special ceremonies, including a full retreat ceremony with a traditional tattoo. The customary musical requirement for such ceremonies normally needs little advance planning.
 - b. A-PD-202-001/FP-000, CF Military Bands and Marches, Volume 1 (Band Instructions) (soon to become A-DH-202-001/FP-001; CAF Music Instructions, Vol 1, Operations and administration).

PLANNING SEQUENCE

4. It is essential to start planning as early as possible. Although traditional or simple retreat and tattoo ceremonies can be arranged on reasonably short notice with local resources, more complex events will require considerable advance planning.

FINANCES

5. Traditional retreat and tattoo ceremonies are often performed as a free public spectacle. More elaborate shows, especially indoors, require admission charges, both to help defray expenses and – often just as important – to attract audiences. The public often associates “free” with amateur performances put on as much to involve the performers as to entertain the audience. Experience indicates that quality shows are expected to have a cost for admission.

6. If government funds have been directly expended for such things as hall deposits, these must be repaid to clear accounts. It is contrary to government regulations to mix public and non-public organizations or outside sponsors or partners. Any profits gained from an event should be contributed to an acceptable charitable organization to avoid charges of advantage.

7. The same considerations apply to merchandising receipts derived from the sale of souvenirs, programmes, recordings and the like.

8. Further information on the subject of finances, sponsors, partners and charities, and communications strategy is contained in A-PD-202-001/FP-000, CF Military Bands and Marches, Volume 1 (Band Instructions) (soon to become A-DH-202-001/FP-001; CAF Music Instructions, Vol 1, Operations and administration)

ANNEX A
NAVAL CEREMONIAL SALUTING
GUN DRILL

GENERAL

1. Naval ceremonial saluting guns are used in the Sunset Ceremony and the Ceremony of the Flags, and may be used in state and military funerals.
2. The gun crew consists of one junior officer (funerals) or petty officer, 1st class (warrant officer) (funerals, Sunset Ceremony or Ceremony of the Flags) and 32 leading seamen/able seamen (corporals/privates). Their positions on the gun are illustrated in Figure 12A-1.

TAKE UP DRAG ROPES

3. On the command TAKE UP DRAG ROPES BY NUMBERS, SQUAD – ONE:
 - a. bend the knees and, keeping the back straight and head up, grasp the loop of the drag rope by the forward edge, with the back of the hand down; and
 - b. simultaneously, numbers 9, 10, 19 and 20, keeping their head and eyes to the front, grasp the pole slats.
4. On the command SQUAD – TWO:
 - a. return to the position of attention; and
 - b. simultaneously, numbers 9, 10, 19 and 20 bring the pole up.
5. On the command SQUAD – THREE:
 - a. drag rope numbers take one pace forward; and
 - b. reverse drag rope numbers take one pace step back.
6. On the command TAKE UP DRAG – ROPES, the three movements are combined. A standard pause is observed between movements.

GROUND DRAG ROPES

7. On the command GROUND DRAG ROPES BY NUMBERS, SQUAD – ONE:
 - a. drag rope numbers take one pace step back; and
 - b. reverse drag rope numbers take one pace forward.
8. On the command SQUAD – TWO:
 - a. bend the knees and, keeping the back straight and the head up, place drag ropes on the ground; and
 - b. simultaneously, numbers 9, 10, 19 and 20 allow the pole to go down.
9. On the command SQUAD – THREE, all assume the position of attention.

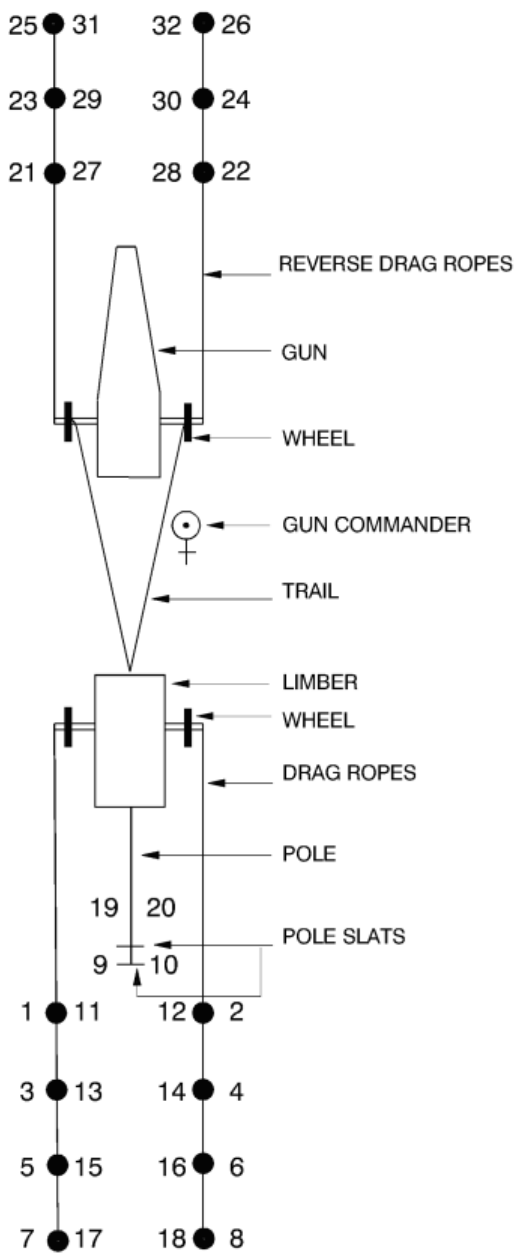

Figure 12A- 1 Order of March, Gun Carriage Crew

10. On the command GROUND DRAG – ROPES, the three movements are combined. A standard pause is observed between movements.

QUICK MARCH

11. On the command QUICK – MARCH, numbers 17 and 18, 27 and 28 lock forearms, grasping the hands, fingers interlocked in a horizontal position. Drag ropes and reverse drag ropes are brought horizontal to the ground by bending the elbows.

WHEELING

12. On the command RIGHT (LEFT) – WHEEL, the gun carriage crew gradually change direction by wheeling, until the command FOR – WARD is given.

HALT

13. On the command GUN CREW – HALT, given as the right foot comes forward and is on the ground:
- a. the crew halts and the drag ropes and reverse drag ropes are brought down to the full extent of the arms; and
 - b. numbers 17 and 18, 27 and 28 unlock their arms and cut their hands to their sides.

OPEN ORDER MARCH

14. On the command OPEN ORDER MARCH, BY NUMBERS, SQUAD – ONE, with the exception of the numbers 9, 10, 19 and 20, the crew turns outwards.

15. On the command SQUAD – TWO:
- a. drag rope and reverse drag rope numbers march out ten paces and halt on the tenth pace at a 90 degree angle to the gun (see Figure 12A-2);
 - b. numbers 1 and 2 let go the drag ropes, and take up a position in rear of the limber;
 - c. numbers 3 and 4 let go the drag ropes, and take up a position at their respective limber wheel; and
 - d. numbers 21 and 22 let go the reverse drag ropes and take up a position at their respective gun wheel, facing inwards.

16. On the command SQUAD – THREE, the reverse drag rope and pole numbers about turn by turning inwards, i.e., odd numbers turn left about, even numbers turn right (Figure 12A-2).

17. On the command OPEN ORDER – MARCH, the three movements are combined. A standard pause is observed between the movements.

UNLIMBER

18. On the command UNLIMBER BY NUMBERS, SQUAD – ONE:
- a. numbers 1 and 2, bending from the waist, take hold of the trail;
 - b. number 1 removes the pin;
 - c. numbers 1 and 2 lift the trail clear of the limber hook;

- d. numbers 3 and 4 grasp the limber wheels, with the backs of their hands down, and hold the limber steady; and
 - e. numbers 21 and 22 take hold of the gun wheels, with the backs of their hands down.
19. On the command SQUAD – TWO:
- a. reverse drag rope numbers take one pace forward;
 - b. numbers 21 and 22 move the gun one pace forward; and
 - c. numbers 1 and 2, holding the trail, take one pace forward.
20. On the command UN – LIMBER, the two movements are combined. A standard pause is observed between the movements.

LOAD

21. On the command LOAD:
- a. the leading numbers (5, 7, 6, 8, 27, 29, 31, 28, 30 and 32) take a pace forward with the outside foot and then kneel on the inside knee, hands crossed on their knee, outside hand on top;
 - b. the rear numbers (11, 13, 15, 17, 12, 14, 16, 18, 23, 25, 24 and 26) take a pace to the rear with the inside foot and then kneel on the inside knee, hands crossed on their knee, outside hand on top;
 - c. the drag ropes and reverse drag ropes are placed on the ground;
 - d. numbers 3 and 4 open their respective limber box lids and then kneel on the inside knee, hands crossed on their knee, outside hand on top;
 - e. numbers 9 and 10 kneel on their inside knee, resting their inside arms on the pole, holding the slat with their outside hand;
 - f. numbers 1, 2, 19 and 20 kneel on their inside knee, hands crossed on their knee, outside hand on top; and
 - g. numbers 21 and 22 take up a position in rear of their respective gun wheel, kneeling on their inside knee with hands crossed on their knee, outside hand on top.
22. Figure 12A-3 depicts the positions occupied by the following numbers:
- a. Number 1, loading number;
 - b. Number 2, extracting number;
 - c. Number 21, firing number;
 - d. Number 22, breech worker;
 - e. Number 3, ammunition supply number;
 - f. Number 4, cylinder return number.

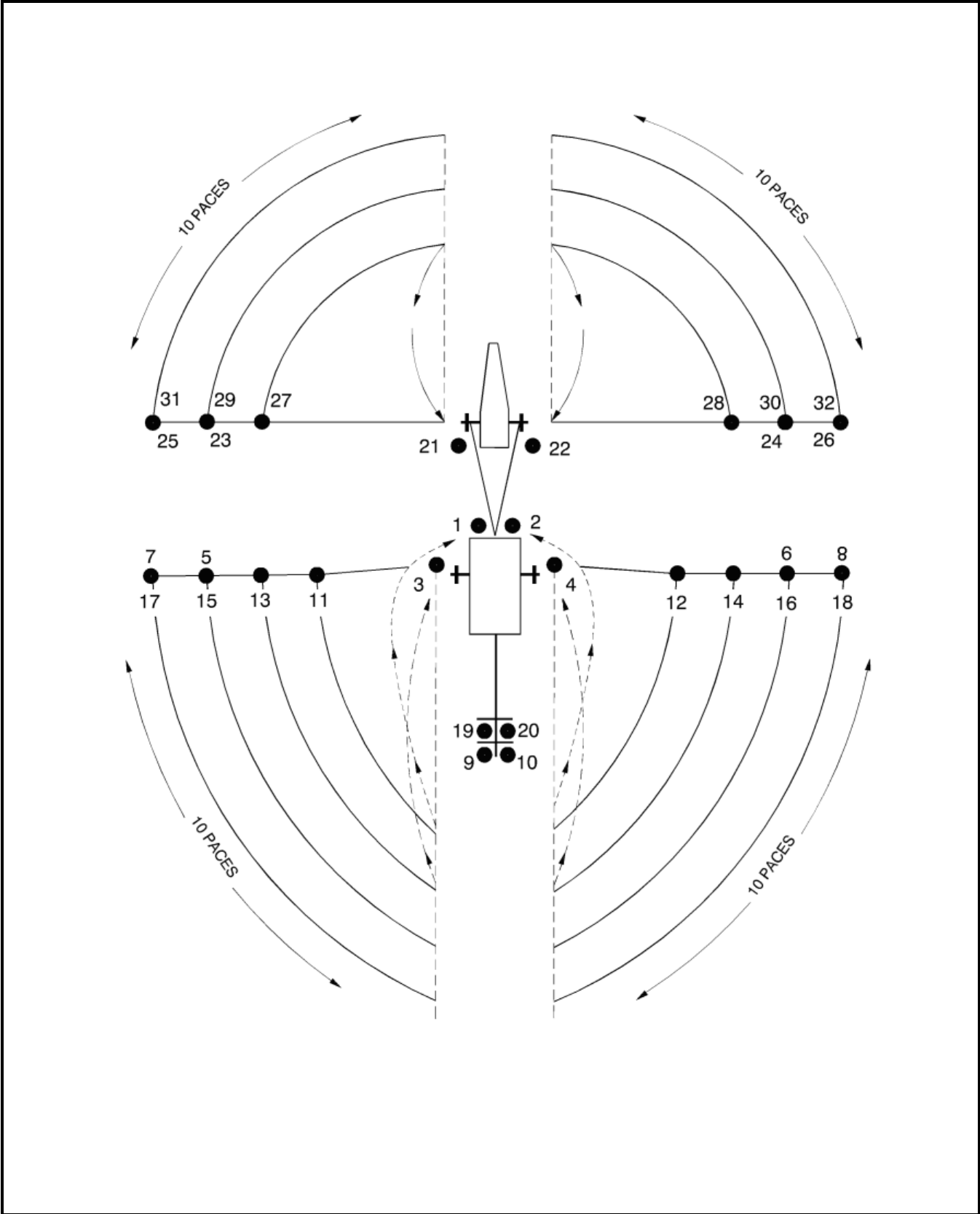

Figure 12A- 2 Open Order March

- A. No. 1 LOADING NUMBER
- B. No. 2 EXTRACTING NUMBER
- C. No. 21 FIRING NUMBER
- D. No. 22 BREECHWORKER
- E. No. 3 AMMUNITION SUPPLY NUMBER
- F. No. 4 CYLINDER RETURN NUMBER

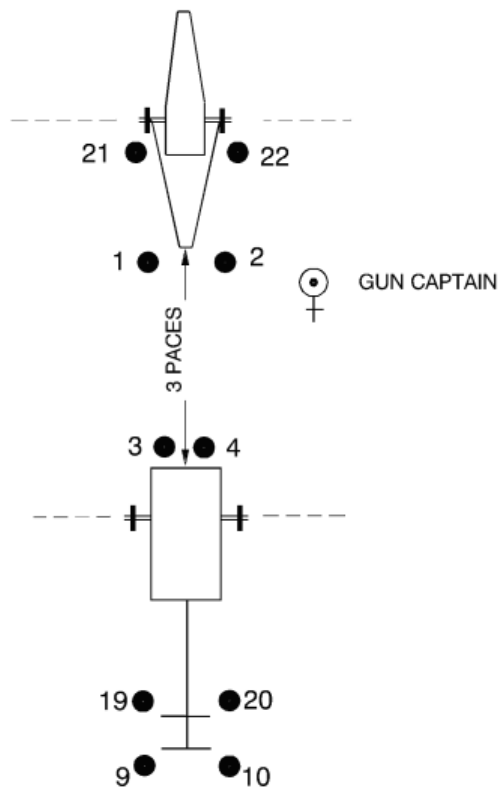

Figure 12A-3 The Load Position

LIMBER UP

23. When the command GUARD, CLOSE ORDER MARCH BY NUMBERS, SQUAD – ONE, is given on the cautionary word GUARD, numbers 3 and 4 shall close the limber box lids.
24. On the executive word of command ONE:
- a. all the gun crew except numbers 1, 2, 3, 4, 9, 10, 19, 20, 21 and 22 bend down and grasp the drag rope loops; and
 - b. numbers 9, 10, 19 and 20 bend down and grasp the pole slats.
25. On the command SQUAD – TWO, all those detailed in subparagraphs 24a and b shall assume the position of attention, holding the drag ropes and pole slats with both hands in front of the body.
26. On the command SQUAD – THREE:
- a. numbers 1 and 2 grasp the trail;
 - b. numbers 3 and 4 grasp their respective limber wheel; and
 - c. numbers 21 and 22 grasp the gun wheels, with the backs of their hands down.
27. On the command SQUAD – FOUR, numbers 1 and 2 lift the trail.
28. On the command SQUAD – FIVE:
- a. drag rope and pole numbers take one pace forward;
 - b. numbers 3 and 4 move to the limber by turning the wheels;
 - c. numbers 1 and 2 place the ring of the trail on the limber hook;
 - d. number 1 replaces the pin; and
 - e. numbers 21 and 22 hold the gun steady.
29. On the command SQUAD – SIX, the gun crew returns to the position of attention.
30. On the command SQUAD – SEVEN:
- a. drag rope and pole numbers about turn by turning inwards; and
 - b. numbers 1, 2, 3, 4, 21 and 22 turn to face their respective position on the drag ropes.
31. On the command GUARD, CLOSE ORDER – MARCH given by the guard commander or the gun commander, the seven movements are combined. A standard pause is observed between the movements.

QUICK MARCH AFTER LIMBER UP

32. On the command QUICK MARCH BY NUMBERS, SQUAD – ONE:
- a. drag rope numbers and reverse drag rope numbers march forward nine paces and halt; and

- b. numbers 1, 2, 3, 4, 21 and 22 step off and take up their positions on the drag ropes.
33. On the command SQUAD – TWO, the drag rope and reverse drag rope numbers turn to the front.
34. On the command SQUAD – THREE, the disengaged hands are cut to the side.
35. On the command QUICK – MARCH given by the guard commander or the gun commander, the three movements are combined. A standard pause is observed between movements.

FUNERAL DRILL – GENERAL

36. For funerals, equipment consists of a field gun carriage, limber, two drag ropes and two reverse drag ropes. The gun carriage is fitted with a funeral board which has straps for securing the casket.
37. The gun crew consists of one junior officer or petty officer, 1st class (warrant officer) and 32 leading seamen/able seamen (corporals/ privates). In a state funeral, four drag ropes and four reverse drag ropes and 28 additional personnel are required (see Figure 12A-4).
38. The gun crew are formed up, at either end of the gun carriage, facing inwards, in four or eight ranks as appropriate (see figures 12A-4 and 12A-5).

FUNERAL DRILL – POSITIONING THE GUN CARRIAGE

39. On the command FALL – IN, the gun crew take up their position beside the drag ropes.
40. On the command LEAD SECTION, ABOUT – TURN, the lead section acts as ordered.
41. On the command TAKE UP DRAG – ROPES:
- a. the drag ropes are taken up;
 - b. the four personnel on the pole lower the pole to level the casket board; and
 - c. numbers 17 and 18 and Numbers 27 and 28 link arms.
42. The gun carriage moves off at the quick march and is positioned to receive the casket. The gun carriage is positioned correctly when the rear section of the gun crew is just clear of the church entrance.

FUNERAL DRILL – RECEIVING THE CASKET

43. On the command LEAD SECTION, ABOUT – TURN, the lead section:
- a. about turns; and
 - b. changes hands on the drag ropes.
44. On the command REAR SECTION, THREE PACES RIGHT AND LEFT CLOSE – MARCH, the rear section act as ordered.
45. On the command REAR SECTION, ONE PACE FORWARD – MARCH, the rear section act as ordered.
46. On the command REAR SECTION, INWARDS – TURN, the rear section act as ordered.
47. The gun carriage is now ready to receive the casket.

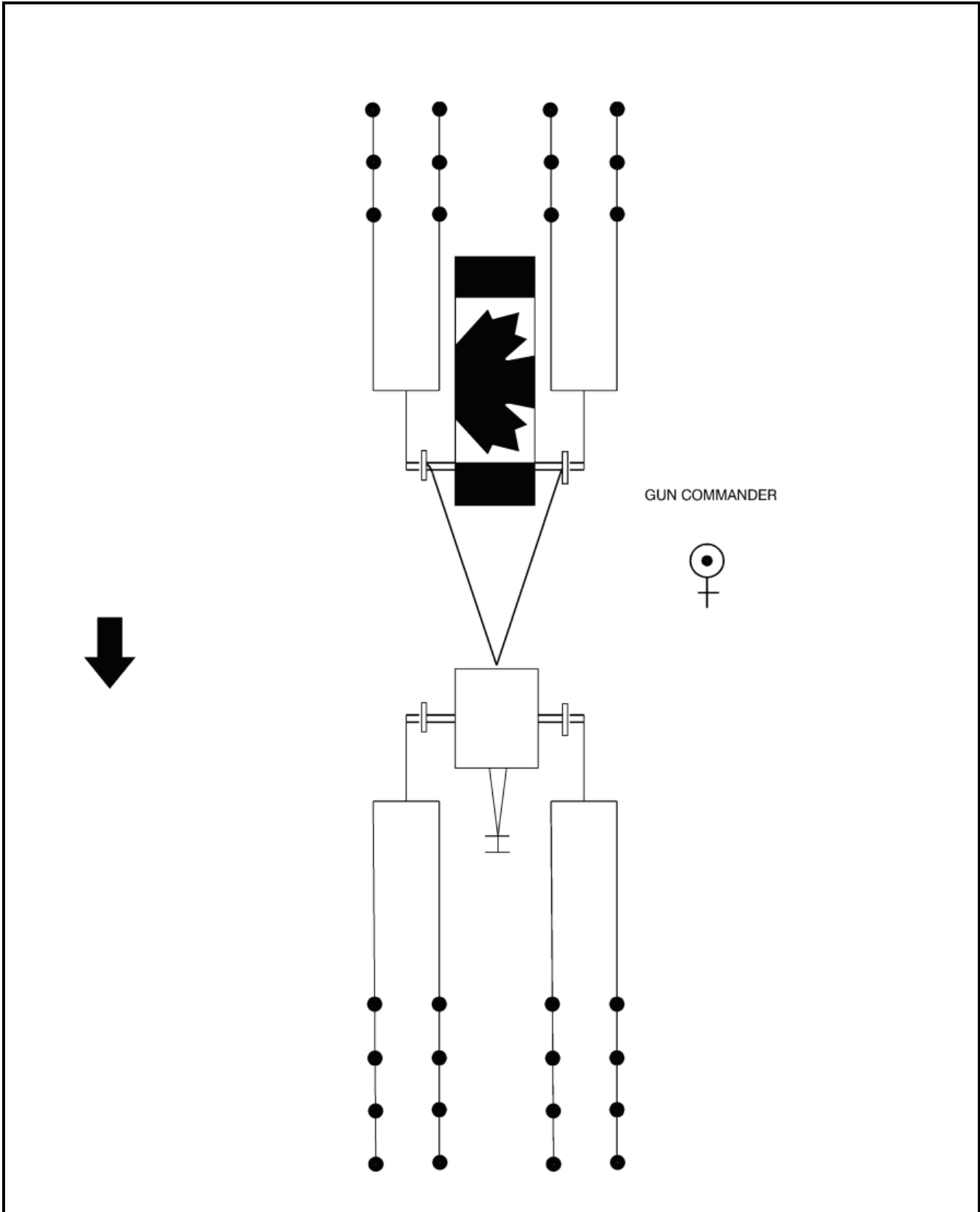

Figure 12A- 4 Naval Gun Crew – State Funeral

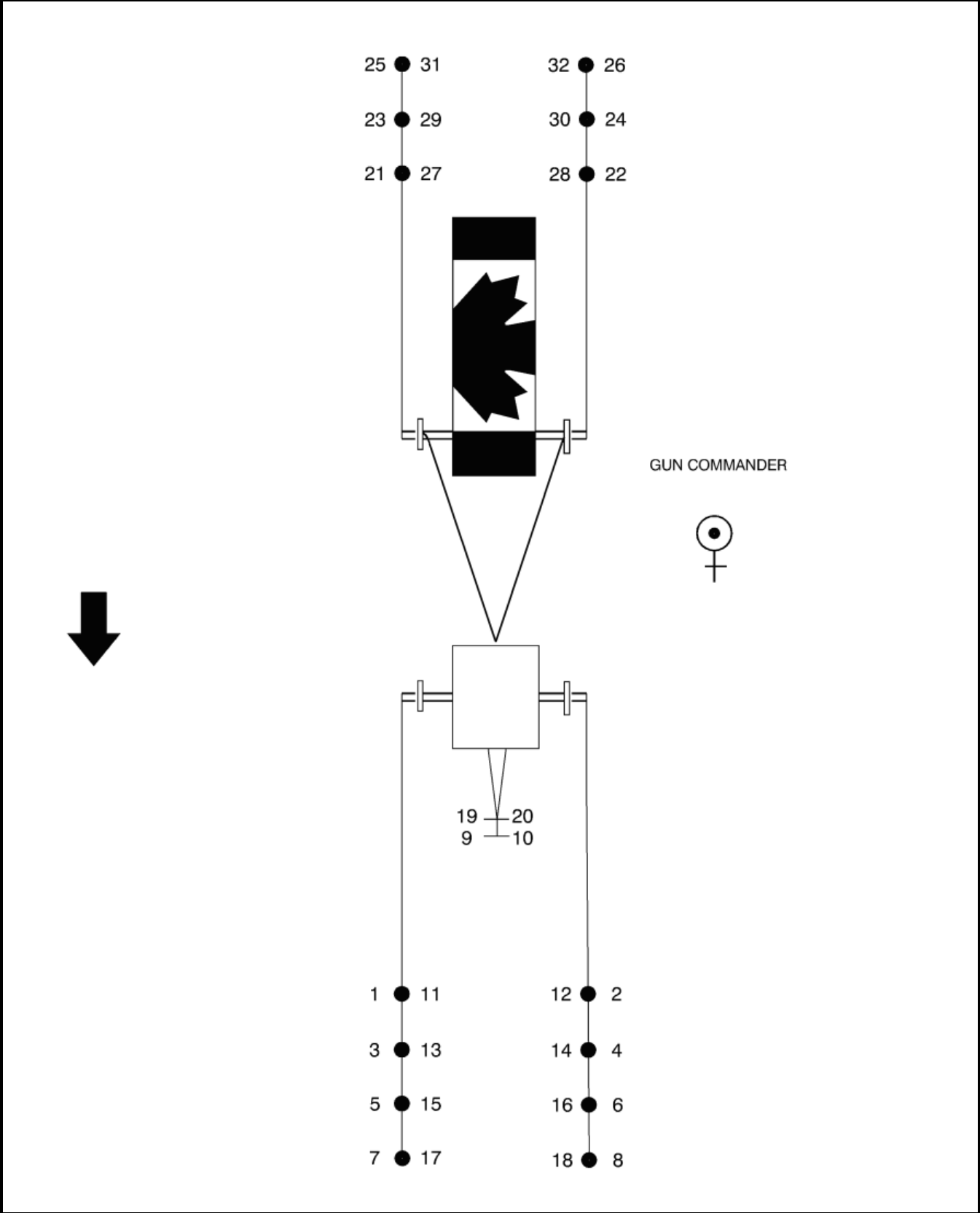

Figure 12A- 5 Naval Gun Crew – Military Funeral

48. When the casket has been secured and the bearer party are in position alongside the gun carriage, on the command LEAD SECTION, ABOUT, REAR SECTION, RIGHT AND LEFT – TURN, the gun crew turn to face the front and the lead section change hands on the drag ropes.

49. On the command REAR SECTION, THREE PACES RIGHT AND LEFT CLOSE – MARCH, the rear section act as ordered.

50. The gun carriage is now ready to move off.

51. While the gun carriage is moving, the rear section shall keep the reverse drag ropes taut.

FUNERAL DRILL – REMOVAL OF THE CASKET

52. After the gun carriage is halted, the command LEAD SECTION, ABOUT – TURN is given.

53. On the command REAR SECTION, THREE PACES RIGHT AND LEFT CLOSE – MARCH, the rear section act as ordered.

54. On the command REAR SECTION, ONE PACE FORWARD – MARCH, the rear section act as ordered.

55. On the command REAR SECTION, INWARDS – TURN, the rear section act as ordered.

56. The casket now is removed from the gun carriage.

CHAPTER 13

PROCEDURES FOR USE ON BOARD SHIP

GENERAL

1. These procedures may be altered to suit the circumstances on any particular ship, but shall be followed as closely as possible in order to ensure commonality throughout the fleet.
2. In order to maintain stability on board a floating vessel, foot drill will be performed by all service personnel in a straight-legged manner with a minimum of bending of the knees. Because of space limitations, distances between individuals and ranks may be reduced.

CEREMONIAL DIVISIONS

3. Ceremonial divisions follow the general procedures for a company parade and inspection described in chapters 7 and 9.
4. When ceremonial divisions are piped, the division chief petty officers or petty officers shall fall in their divisions at designated locations. Each division will fall in, in either two or three ranks according to the space available, facing inboard. Supernumerary petty officers shall fall in on the right flank of their respective divisions and the division petty officer will take his place one pace in front of the centre of his division, facing the division. If a division consists entirely of petty officers, they shall fall in as above, but in decreasing order of seniority from the right.
5. After falling in, each division shall be numbered, sized, open ordered and stood at ease. While being sized, the supernumerary petty officers shall stand fast, the remainder of the division sizing on their left. If space is limited, the movement during the open order drill may be restricted, i.e., ONE PACE OPEN ORDER – MARCH. Alternatively, the open order may be omitted and the procedure in paragraph 8 carried out. After ordering these movements, the division petty officer shall turn about, facing the front and stand at ease.
6. When the division officer approaches his division, the division petty officer shall come to attention and order his division to attention. As the division officer halts in front of the division petty officer, the division petty officer shall salute and, after the salute is acknowledged, report the division to the division officer.
7. As the division officers assume command of their divisions, supernumerary officers shall fall in. When divisions are held on a flight deck or in a ship's hangar, they shall fall in athwartships at the forward end of the deck (see Figure 13-1).
8. Accompanied by the division petty officer, each division officer shall inspect his division. If space has not permitted the division to be at the open order (see paragraph 4), each rank shall be marched one pace forward following the inspection of its front.
9. On completion of the inspection, each division petty officer shall fall in one pace to the right of the front rank or one pace centre rear of his division (as space allows), and each division officer shall fall in one pace front and centre of his division. If space has not allowed the division to be at the open order, the division officer shall then order DIVISION, ONE PACE STEP BACK – MARCH, or if the division is at the open order, DIVISION, CLOSE ORDER – MARCH.
10. Each division officer then shall report his division to the executive officer and, when ordered to fall in, shall return to his position in front of his division and stand his division at ease. The executive officer shall take up a central forward position or a position on the flank from which the commanding officer will approach the divisions.
11. On the arrival of the commanding officer, the executive officer shall call the ship's company to attention and report the divisions to the commanding officer. Each division then may be inspected by the commanding officer and/or the executive officer.

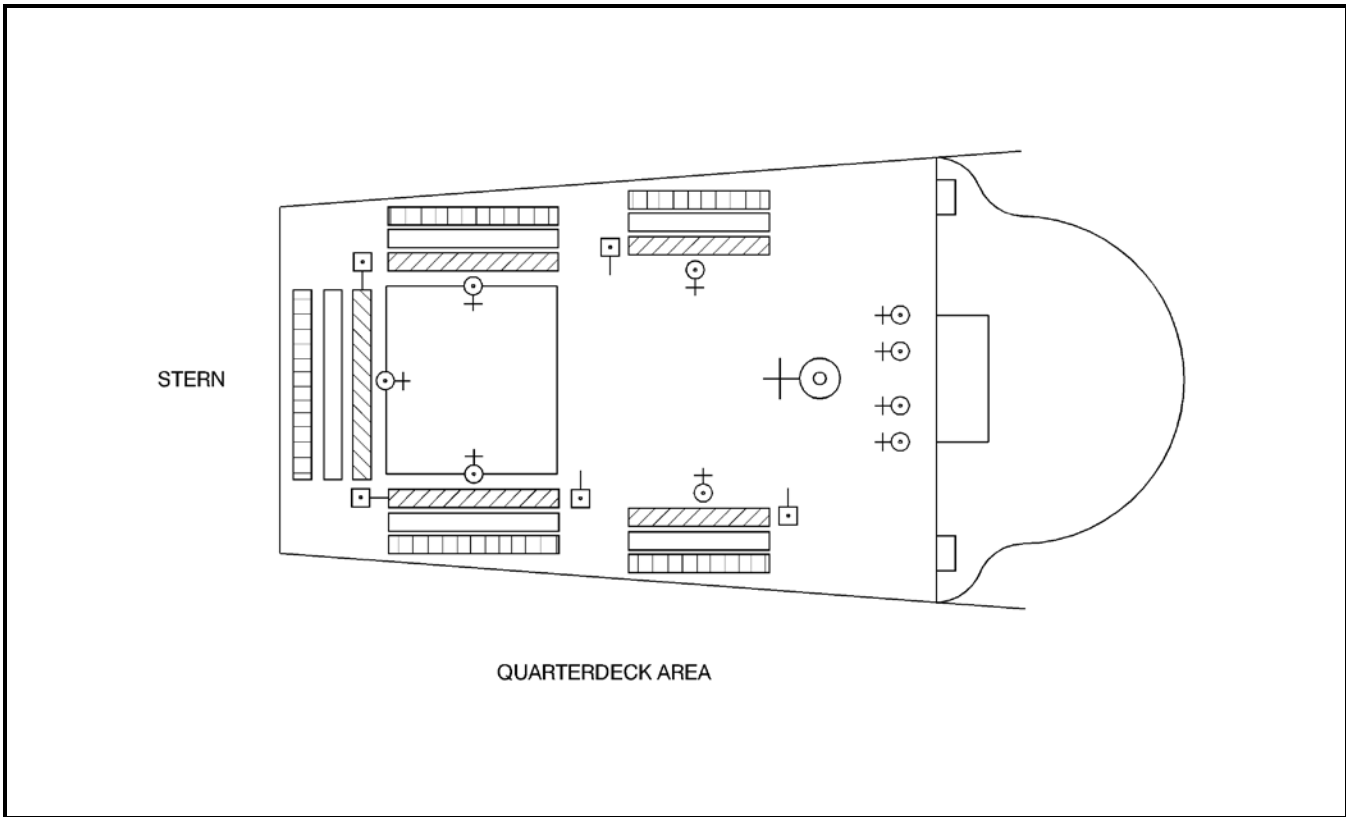

Figure 13-1 Divisions

12. After the completion of the inspection, awards and presentations shall be made and a prayer service may be conducted by either a chaplain, the commanding officer or a selected officer.

13. Following the prayer service, the executive officer shall call the ship's company to attention and report to the commanding officer. If the commanding officer does not desire to address the ship's company, divisions shall remain at attention until the commanding officer has departed. If the commanding officer does desire to address the ship's company, the executive officer shall order SHIP'S COMPANY, STAND AT – EASE; and STAND – EASY. Following the address, the executive officer shall order SHIP'S COMPANY, ATTEN – TION. After the departure of the commanding officer, the executive officer shall fall out the officers. The executive officer then shall dismiss the petty officers, following which he shall turn over to the coxswain to dismiss the remainder of the ship's company.

DAILY DIVISIONS

14. The procedure for daily divisions is the same as for ceremonial divisions, except there is no commanding officer's inspection.

EVENING QUARTERS

15. The procedure for evening quarters is the same as for daily divisions.

PROCEDURE FOR ENTERING AND LEAVING HARBOUR

16. Depending on the space and number of personnel available, divisions shall be formed in one, two or three ranks. All parties of officers and non-commissioned members are to be sized as follows:

- a. on the forecastle – tallest forward;
- b. on the quarterdeck – tallest aft; and

- c. amidships – normal sizing.
17. Officers, petty officers, signalmen and part ship hands shall fall in as follows (Figure 13-2):
- a. The foc'sle part ship hands shall fall in, standing fore and aft, facing the designated side. The foc'sle officer stands facing forward in the eyes of the ship. The foc'sle petty officer and the signalman shall stand athwartships aft of the part ship hands, facing forward.
 - b. The top part ship hands shall fall in, standing fore and aft, facing outboard on the designated side. The top part ship officer shall stand forward of and in line with the top part ship hands. The top petty officer and the signalman shall position themselves between and in line with the officers and the hands.
 - c. The quarterdeck part ship hands shall fall in, standing fore and aft, facing outboard on the designated side. The quarterdeck officer shall be foremost followed by the quarterdeck petty officer and signalman, followed by part ship hands.
 - d. When the ship is proceeding astern, the foc'sle officer and the quarterdeck officer shall face aft.
18. The guard and band shall fall in where designated.
19. When the "Alert" is sounded on the bugle or the "Still" is piped on the boatswain's pipe, divisions are to be brought to attention by their division petty officer and are to be stood at ease when the "Carry On" is sounded. The executive officer only shall salute when the "Alert" or "Still" is sounded.
20. On special occasions when other members of the ship's company wish to fall in on entering or leaving harbour, they shall fall in a designated area, under command of the senior non-commissioned member present, and shall conform with the instructions as detailed in paragraphs 17 to 19 above.

MANNING AND CHEERING SHIP

21. On the command FALL IN FOR MANNING – SHIP, the ship's company shall fall in as for divisions. The chief boatswain's mate shall then designate to each division petty officer an area which his division shall man, ensuring as closely as possible that an equal number of personnel are being designated to either side of the ship. Upon arriving at the designated area, the division petty officer shall position his division so that each member is at attention, facing outboard, one pace clear of the guard rail.
22. On the command DRESSING FORWARD, RIGHT AND LEFT – DRESS given by the executive officer, using the upper deck broadcast system, personnel on either side of the ship shall dress forward. The interval in dressing shall be as space permits, appropriate changes being made in the word of command.
23. On the command MAN – SHIP, each man takes one pace forward and grasps the guard rail with both hands, crossing hands with the man forward of him, when doing so.
24. The executive officer shall then order STAND BY TO CHEER, SHIP'S COMPANY, ATTEN – TION.
25. On the commands REMOVE HEAD – DRESS; THREE CHEERS FOR ____; and HIP HIP – HURRAY, the headdress is held in the right hand with the right arm fully extended in front of the body and parallel to the deck, the headdress being circled clockwise during the HURRAY, with crown outboard.
26. On completion of the three cheers the executive officer shall order REPLACE – HEADDRESS.
27. The ship's company then may be ordered to dismiss by one of the following methods:
- a. the "Disperse" being sounded on the bugle;
 - b. the "Carry On" being piped; or
 - c. the command DIS – MISS given by the executive officer.

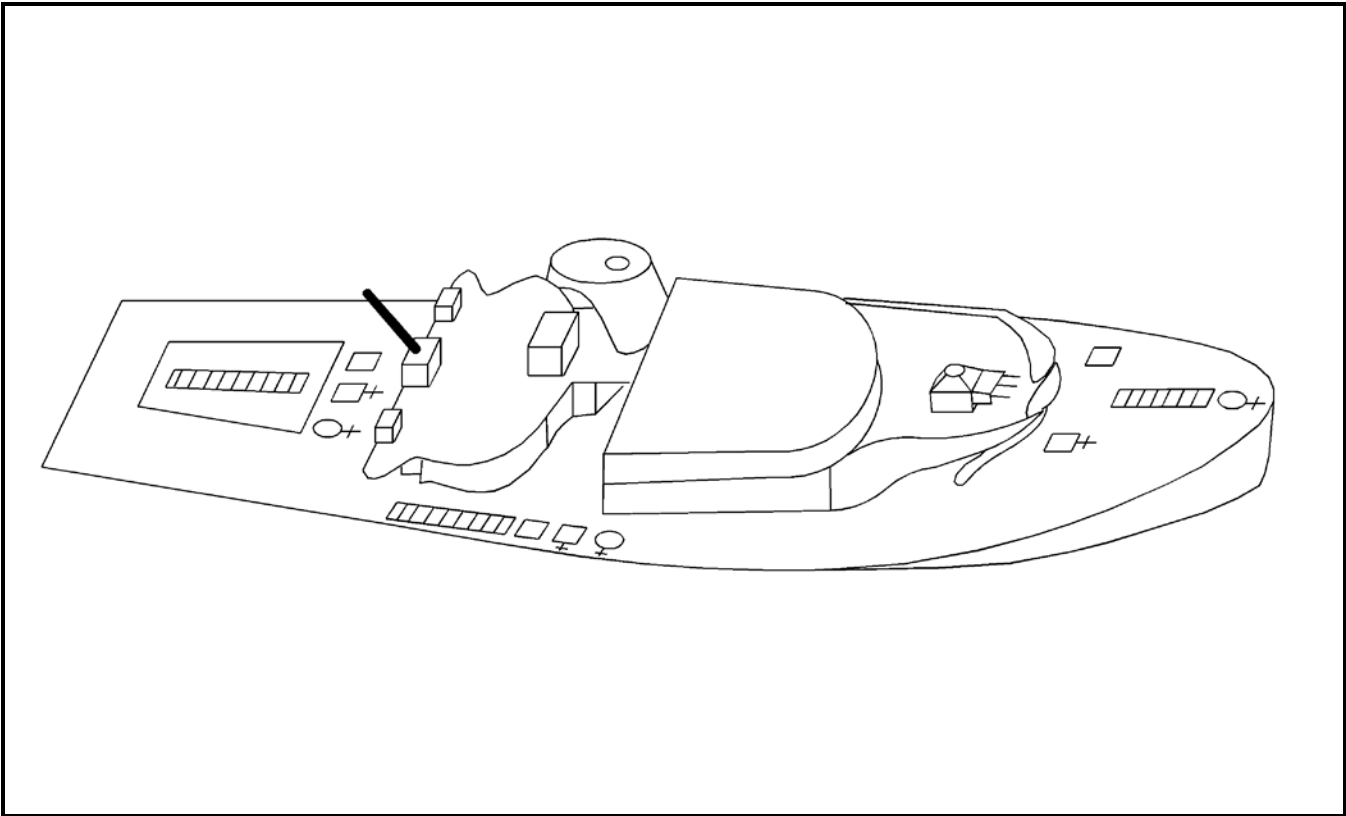

Figure 13-2 Hands to Station – Entering and Leaving Harbour

28. Upon being dismissed, the ship's company shall turn forward prior to moving off.

GUARDS

29. Because of the limitations imposed by space, guards detailed for Colours or to receive a dignitary aboard ship shall consist of the following personnel:

- a. one lieutenant (N) or sub-lieutenant (N);
- b. one petty officer; and
- c. 24 other non-commissioned members maximum, or 12 other non-commissioned members minimum.

COLOURS

30. Ships of destroyer size normally will not parade guards at Colours. However, if the occasion arises, the procedure detailed below will be followed.

31. The guard shall be assembled in a designated area with bayonets fixed and be fallen in facing aft in two ranks athwartships. The guard petty officer shall size and dress the guard at the open order in two ranks and then hand over the guard to the guard commander. After assuming command, the guard commander shall draw his sword and then order GUARD, STAND AT – EASE. The petty officer falls in on the right of the front rank. The bugler falls in on the right of the front rank, one pace clear.

32. The officer of the day or watch, or a designated officer, the leading seaman of the gangway and the ceremonial piping party shall be positioned in a designated area.

33. The preparative pennant shall be hoisted on the foremast five minutes prior to Colours. The signalman, positioned aft by the ensign staff and facing forward so that the preparative is in view, shall call FIVE MINUTES TO COLOURS, SIR.

34. At one minute before Colours, the signalman shall call ONE MINUTE TO COLOURS, SIR, and the guard commander shall then order GUARD, ATTENTION; and GUARD, SHOULDER – ARMS.

35. At Colours, the preparative pennant is lowered to the dip and the signalman shall call COLOURS, SIR. The bugler immediately sounds the “Alert”, or the “Still” is piped, and the guard commander orders GUARD, GENERAL SALUTE, PRESENT – ARMS.

36. On completion of the salute, the guard commander shall order GUARD, SHOULDER – ARMS. The preparative pennant then shall be lowered and, upon completion, the “Carry On” is sounded by the bugler or piped by the ceremonial side party. The guard then is ordered to order arms and unfix bayonets and is dismissed.

GUARDS OF HONOUR

37. Fifteen minutes before the arrival of the dignitary, the guard shall be called to fall in:

- a. by the bugler sounding, “Guard” and “Band” or “Buglers”; or
- b. by the boatswain’s pipe sounding “General Call” over the broadcast system and the verbal announcement “Guard fall in, ceremonial side party close up”.

38. The guard shall assemble near the gangway with bayonets fixed. Under command of the guard petty officer, they will fall in at the open order and in two ranks facing outboard. The guard shall be sized and dressed as space permits, then handed over to the guard commander. After assuming command, the guard commander shall draw his sword and order GUARD, STAND AT – EASE.

39. When the boat carrying the dignitary is two or three lengths away from the accommodation ladder, the “Alert” is sounded and the guard commander orders GUARD ATTENTION; and GUARD, SHOULDER – ARMS. Upon the completion of these movements, the ceremonial side party shall “Pipe the Side”, if the dignitary is so entitled. A second “Pipe the Side” shall be given once the dignitary has positioned himself on the platform of the accommodation ladder.

40. As soon as the dignitary steps on board and is properly positioned, the guard commander shall order GUARD, ROYAL (GENERAL) SALUTE, PRESENT – ARMS. Upon the completion of the appropriate musical salute, the guard commander orders GUARD, SHOULDER – ARMS; and GUARD, ORDER – ARMS, then reports to the dignitary, who may inspect the guard. Upon the completion of the inspection, the guard commander shall salute the dignitary, who then shall be escorted to the wardroom or other location by the commanding officer. The guard may then be fallen out until needed again for the departure.

41. The departure ceremony is similar to that for the dignitary’s arrival. As the dignitary approaches the top of the gangway, the “Alert” is sounded. The guard commander orders GUARD, ATTENTION; and GUARD, SHOULDER – ARMS. As the dignitary assumes his position, the guard commander orders GUARD, ROYAL (GENERAL) SALUTE, PRESENT – ARMS. Upon completion of the sounding of the appropriate salute, the guard commander orders GUARD, SHOULDER – ARMS. As the dignitary steps onto the upper platform of the accommodation ladder, the ceremonial side party shall “Pipe the Side”. As the boat leaves the accommodation ladder, the ceremonial side party shall again “Pipe the Side”.

42. The guard then shall be ordered to order arms and unfix bayonets before being dismissed.

SALUTING ON BOARD

43. All officers and non-commissioned members shall salute when coming on board or leaving a commissioned warship.

44. Non-commissioned members shall salute when addressing, or being addressed by, an officer, and again on withdrawing.

45. Officers and non-commissioned members shall face in the required direction and, if wearing headdress, salute:

- a. whenever the National Anthem or any foreign national anthem is played;
- b. when Colours are hoisted; and
- c. when Colours are lowered at sunset.

46. For the occasions noted in paragraph 45, parties of non-commissioned members fallen in are to be called to attention, the officer or non-commissioned member in charge saluting.

PIPING THE SIDE

47. Between Colours and sunset, the side shall be piped to the following, coming on board or leaving one of Her Majesty's ships:

- a. the Queen;
- b. the Governor General;
- c. Lieutenants-Governor within the limits of their jurisdiction;
- d. members of the Royal Family of the rank of captain (N) and above when in naval uniform;
- e. the Naval Board when in uniform;
- f. all Canadian admirals, general officers and commodores in uniform, and Commonwealth commodores and above in uniform;
- g. all officers in uniform holding an appointment in command of a ship or formation of ships;
- h. members of a court-martial attending or leaving the court;
- i. officer of the guard when flying a pennant; and
- j. when a corpse is brought on board/ashore and when the body is committed to the sea.

48. All naval officers in command of a ship or formation of ships, of other than Commonwealth navies, when in uniform should be piped at all hours.

CHAPTER 14

BAND DRILL

SECTION 1

INTRODUCTION

GENERAL

1. Bands provide a regular marching cadence and musical accompaniment which, when combined with high standards of drill and precise manoeuvre, contribute immensely to the success of parades and ceremonial occasions.
2. The hallmarks of Canadian Forces drill are efficiency, precision, and dignity, qualities developed through self-discipline and practice. Standard CF foot, mace and instrument drill must be used by bands of all types, whether performing individually or in combination with others. Routine adherence to standard band drill and control signals should eliminate the need for retraining when bands, corps of drums, trumpets, bugles, and pipes and drums from different units are combined or massed.
3. Instructions on the positioning and actions of bands on parades and in ceremonies can be found elsewhere in this Manual, particularly in Chapter 9, Battalion Ceremonial; Chapter 10, Guards of Honour; Chapter 11, Religious Services and Funerals; and Chapter 12, Miscellaneous Ceremonial.
4. The content of this chapter is limited to drill movements and procedures unique to bands. Deviations from these standards may be necessary, but deviations are not to be accepted as the norm:
 - a. to meet requirements for special ceremonial occasions and duties;
 - b. because of physical and/or acoustic limitations of parade grounds and routes; and
 - c. because of inclement weather.
5. Detailed instructions are in the following sections:
 - a. Section 2 – Instrument Drill;
 - b. Section 3 – Conductor and Drum Major;
 - c. Section 4 – Band Formations and Manoeuvre;
 - d. Section 5 – Visual and Audible Control Signals and Mace Drill; and
 - e. Section 6 – Parade Procedures and Techniques.

DIRECTION AND CONTROL – KEY PARADE APPOINTMENTS

6. Bands are either an integral part of the unit or formation on parade or under the operational command of the parade commander. While musicians and bands act on the verbal commands of the parade commander, they also respond to the visual signals of their conductor or drum major, thus reducing the need for separate commands to the band. When bands of different types are combined, the brass-reed band conductor shall normally be in charge of the combined bands.
7. **Conductor.** The conductor is the officer or non-commissioned member (NCM) responsible for directing the musical performance of a band, e.g., director of music, or bandmaster.

8. **Drum Major.** The drum major is the NCM responsible for leading the band on the march and for controlling the drill movements, and the musical action (where it is not practical for a conductor or pipe major to do so) of a band during parades. When there are multiple drum majors on parade, one shall be formally appointed as the principal drum major, responsible to coordinate and control the actions of combined and massed bands and of the other drum majors, all of whom shall signal in unison.

9. **Pipe/Trumpet/Drum/Bugle Major.** The NCM responsible for leading the performance of their band/corps.

10. **Bass Drummer.** The bass drummer is the NCM responsible for establishing and maintaining tempo. The bass drummer acts like an auditory extension of the drum major's or conductor's visual signal, while at the same time maintaining a judicious balance between audible cues and the music being played, according to the mood and tone of the occasion. Drum taps are used as cautionary signals when voice commands are not practical, and may be used as executive commands when visual signals might not be seen clearly by all. However, drum taps need not and should not be routinely employed as executive commands. When there are multiple bass drummers on parade, one shall be appointed to establish and maintain tempo and to use drum signals where necessary.

11. **Leading Side Drummer.** The leading side drummer is the NCM responsible for performing the solo beatings and for providing drum taps to coordinate the actions of other band members when verbal commands do not suit the form of ceremony or duty. They are also responsible to call the patterns, or drum-links, to be performed by the drum section, and provide cadence and audible signals when it is not appropriate for the bass drum to do so, e.g., when the band are marching by themselves and not playing.

MUSICAL MARCHING DISPLAYS

12. Special drill movements and sequences may be performed during displays such as tattoos or military pageants, often to memorized marching routines and without the normal sequence of visual or audible signals. Display routines are most effective and are in the best interests of the CF if there is little deviation from standard drill movements.

STARTING MUSIC ON PARADE

13. When playing a quick march for marching troops, it is preceded normally by two 3-pace rolls (see Figure 14-A-1). Normally, before a slow march is played on parade it is preceded by two bass drum beats (see Figure 14-A-2). In slow time, music may commence without tempo-setting drum beats, e.g., in the "Band Troop" sequence in a Trooping the Colour ceremony.

SECTION 2

INSTRUMENT DRILL

BASIC POSITIONS

1. The basic positions for holding musical instruments are illustrated in Figures 14-2-1 through 14-2-19. These positions may have to be adjusted to allow for differences in instrument size, playing techniques, and the wear of traditional dress accoutrements.
2. The Carrying / Attention position is the normal position for carrying an instrument; it is also used when marching and marking time while not playing. When marching in quick time, the right or disengaged arm shall be swung waist high if the instrument so allows. When standing at attention for a long period of time, an instrument can be held with both hands in front of the body, lowered to the side or, if directed by the conductor or drum major, placed on the ground.

CHANGING POSITIONS

3. Movement between positions shall be by the most direct route possible with the instrument. On completion of the movement, minor adjustments may be necessary as required by instrument differences.

INTERMEDIATE POSITION

4. To effect the movement of instruments in unison between carrying and playing positions, a transitory position called the Intermediate Position may be utilized in conjunction with the conductor's or drum major's direction, the tempo-setting rolls in quick time or bass drum beats in slow time. Not all instruments have an Intermediate Position.

PLAYING POSITION FROM THE CARRYING POSITION

5. To move an instrument to the playing position from the carrying position:
 - a. adopt the intermediate position. In quick time, the movement is made on the beginning of the first part of the drum rolls. In slow time the movement is made on hearing the command "march" (i.e., SLOW – MARCH). (Musicians performing on instruments without an intermediate position shall move their instruments on b., below); then
 - b. bring the instrument into the playing position. In quick time, the movement to the intermediate position is made on the first beat of the first set of rolls and brought to the playing position at the start of the second set of drum rolls. In slow time, instruments should be brought to the intermediate position on the first bass drum beat and to the playing position on the second beat of the bass drum.

NOTES

1. For a suspended (cord slung) bugle or natural trumpet, the musician shall simply grasp the instrument as the intermediate position. These instruments will usually be slung by cords from the left shoulder to rest below the right hip at the carrying/attention, stand at ease and stand easy positions.
2. Drummers and pipers shall be in the playing position before the commencement of the rolls or bass drum beats. The leading side drummer will give a double tap to signal "pipes ready" and for all drummers to move to the playing position.
6. To commence playing at the halt without drum rolls/beats, the conductor signals the movement from the carry position to the playing position, all in one motion (see Section 3). Musicians performing on

instruments that use Intermediate Positions will move through these positions in one fluid motion in order to get to the playing position.

CARRYING POSITION FROM THE PLAYING POSITION

7. To move an instrument to the carrying position from the playing position when at the halt:
 - a. adopt an intermediate position when the drum major drops the mace, or when the conductor drops their arms (musicians performing on instruments that do not have an intermediate position will adopt the carrying position); then
 - b. adopt the carrying position after one complete second (imagine 2 paces are taken), and move the disengaged arm to the side.
8. The carrying position from the playing position when on the march:
 - a. adopt the intermediate position when the drum major drops the mace; then
 - b. adopt the carrying position on the next left foot; the disengaged arm to the side and, if marching in quick time, swung on the following left foot.

NOTES

1. For a suspended (cord slung) bugle or natural trumpet, when executing the movement described in paragraph 8.a. above, the musician shall simply return the instrument to the 'slung' position, it being the intermediate position.
2. In units where the bugle is not slung, and when doubling, the bugle may be carried with the bell on the right hip.
3. When both the trumpet and the bugle are carried slung, the trumpet will be slung across the back and the bugle suspended at one point, bell up.
4. When through long established custom the piston bugle is always carried in the right hand, this practice may continue when the band is the only one on parade or when participating in a street parade.

CHANGING MUSIC

9. Music is changed with a disengaged hand while holding the instrument:
 - a. at the halt, music is changed when at normal attention or at ease, depending on the posture of the parade;
 - b. on the march, changing the music is accomplished over the course of a musical phrase, usually 16 paces starting on the left foot when the instrument is brought down to the intermediate position after ceasing to play. When the music has been changed, the hands and instrument are kept in the intermediate position until the final left foot of the phrase (usually the 15th pace) when the instrument is brought to the carrying position and the disengaged hand is cut to the side. In quick time the disengaged arm is swung on the following left foot; and
 - c. when there is no rest between musical selections, music cards are changed in the playing position.

GROUNDING AND TAKING UP INSTRUMENTS

10. Excluding heavy instruments (such as tuba and bass drum), instruments shall only be rested or placed on the ground on appropriate occasions when ordered.
11. On being ordered to GROUND - INSTRUMENTS or TAKE UP –INSTRUMENTS the action shall be the same as for rifle drill (see Chapter 4, Section 1, paragraph 19, etc.) The instrument is placed carefully on the ground just in front of the left foot. A standard pause shall be observed between the movements.
12. If the playing position is to be assumed, a cautionary command can be given, i.e., TO THE PLAYING POSITION, TAKE UP — INSTRUMENTS.
13. If a musician is called out of formation to receive an award or other recognition, that individual shall ground the instrument, step back one pace, turn right and march to the award area, and salute as appropriate (see Chapter 1, Section 2, Reporting). On completion, the individual shall re-enter from the left of the band, wheel into position, halt, and take up the instrument.

COMPLIMENTS (SALUTING)

14. The carrying (attention) position for most musical instruments allows the right hand to be used for saluting. Compliments given by formed military groups and individuals are explained in Chapter 1, Section 2, and Chapter 2, paragraphs 36 to 43. Additionally:
- a. formed military groups: when a band or band detachment is in formation (a formed military sub-unit under command) the conductor or the drum major or the senior person in command shall call the band or band detachment to attention (if marching but not playing, order EYES – RIGHT/LEFT) and shall alone salute with the hand. On parade, the conductor and the drum major shall alone salute with the hand when marching past a dignitary/saluting point, although not while simply parading in front, e.g., when performing the band “troop” during a Trooping the Colours ceremony (see Section 3);
 - b. individual: when physical incapacity or the carriage of a musical instrument makes a salute with the right hand impractical, individual compliments shall be paid by standing to attention, or turning the head and eyes to the left or right when on the march. The natural trumpet, when carried in the hand, is held so that the bell rests on the right hip, the instruments at a slightly outwards angle. As such, the trumpeter pays compliments by simply coming to attention and turning head and eyes in the required direction;
 - c. group of individuals: when marching from one point to another and not part of a formed military group, all members pay individual compliments to an approaching higher ranking officer. When an officer approaches a stationary group of musicians, the senior member of the group shall call the others to attention and shall alone salute with the hand; and
 - d. musicians are not normally required to remove headdress when performing musical duties, unless seated indoors. When acknowledging audience applause, conductors wearing headdress shall salute with the hand normally. Similarly, military band soloists wearing headdress shall salute their conductor before acknowledging audience response.

SECTION 3

CONDUCTOR AND DRUM MAJOR

GENERAL

1. A brass-reed band requires a conductor. A band will normally have a drum major (see Section 4).

INDICATIONS FROM CONDUCTOR

2. When a brass-reed band is static, normally the conductor will indicate the following:
 - a. the start of a piece of music and / or the commencement of the rolls (in quick time) or bass drum beats (in slow time);
 - b. the ending of a piece of music (including the commencement of the bass drum signal);
 - c. the raising of instruments to the playing position; and
 - d. the lowering of instruments to the carrying position.
3. To indicate the start of a march, the conductor raises their left arm such that it is parallel to the ground, and extends the index finger of their left hand while at the same time obtaining eye contact with the bass drummer and other percussionists. On the word of command (QUICK – MARCH, for example), the conductor cues the drums to play the rolls or if in slow time, the bass drum beats (see Figures 14-A-1 and 14-A-2).
4. To indicate the raising of instruments to the playing position from the carry position, the conductor surreptitiously moves their arms in order to get the musicians' attention. At the end of the first set of rolls, the conductor raises their arms in a sweeping motion to their conducting plane, reaching the top on the silent beat (see Figure 14-3-1). All instruments must be in playing positions when the conductor reaches the top of their plane.
5. To indicate the end of a march, the conductor raises their left arm such that it is parallel to the ground, and extends the index and middle finger of their left hand (in a "V" position) while at the same time obtaining eye contact with the bass drummer. (While the music would normally be cut at an appropriate place, there will be occasion where the music must be cut in a non-musical spot.) On the beat before where the conductor wants the bass drummer to play the first double tap (see Figure 14A-4), the conductor executes a "prep" with the left hand, and on the down beat, indicates the "V" to the bass drummer (wherein the bass drummer will play Figure 14A-4). The conductor continues to conduct with the right hand while executing the above. Normally, the conductor then cuts the band on the third beat after the figure (indicated with both hands) (see Figure 14-3-2).
6. To indicate the lowering of instruments from the playing position to the carry position, the conductor gives an upbeat with both hands / arms, and then on the next beat (as if the music were continuing) lowers their arms to their side (see Figure 14-3-2). Instruments are lowered when the conductor's arms are lowered and, if part of the musician's drill, the musician's arm is cut to the side on the next imaginary left foot.

BATON CARRIAGE

7. Band personnel utilize standard foot and sword drills as detailed in Chapters 2, 3 and 6. Swords are hooked-up to keep the left hand free for use. When not conducting, the baton is held in the right hand, or in the left hand with the handle held in the palm of the closed hand, with the shaft of the baton running along the wrist and up the left outside of the sleeve with the point towards the elbow. To transfer the baton to the right hand for conducting, both hands are brought forward to mid-chest and the baton

transferred; the procedure is reversed to transfer the baton to the left hand. When marching, the baton, held in the left hand as previously described, moves with the left arm. When marching in quick time both arms are swung. (See Figure 14-3-3.)

POSITIONING ON THE MARCH

8. The drum major marches six paces in front of and centred on the band.
9. The conductor normally marches on the right flank of the band in line with the front rank. (See Section 4.)

EXCHANGING POSITIONS AT THE HALT

10. When the conductor and the drum major exchange positions on parade, the exchange shall be completed in crisp military fashion.
11. The band having marched into position and halted, with the conductor on the band's right flank:
 - a. the drum major signals to the conductor that they will vacate the lead position by turning about to face the band, obtaining eye contact with the conductor, bringing the mace to the carry position and cutting the right arm to the side. The conductor must be able to see the drum major move the mace to the carry position;
 - b. after a mental check pace (right foot), the drum major and the conductor both step off at the same time on the following left foot, either with or without music;
 - c. the drum major proceeds by a series of wheels around the right flank to take up a position beside the right marker. Similarly, the conductor takes up a position in front of the band from where they can conduct. Both pass each other left shoulder to left shoulder to avoid a collision; and
 - d. the drum major and conductor should halt at the same time. The number of paces required will be adapted to the situation and band formation.
12. On the completion of conducted music, or when the band is about to move, the conductor, facing the band, indicates that they will return to their previous position by ceasing to conduct, coming to attention, and looking directly at the drum major:
 - a. the drum major initiates the exchange of positions by bringing the mace to the carry position and cutting the right arm to the side;
 - b. same as 11.b.;
 - c. the drum major proceeds to take up a position in front of the band, the conductor proceeding by a series of wheels to take up their original position, passing each other left shoulder to left shoulder to avoid a collision; and
 - d. same as 11.d..
13. If possible, exchanges of positions should be coordinated with the actions of other principals on parade (e.g., wait until a parade commander moves to resume their normal or next position on parade).
14. The exchange of positions is not undertaken with multiple drum majors on parade (i.e., in combined or massed bands). The designated conductor moves on their own.

SALUTING ON THE MARCH IN QUICK TIME

15. In quick time, the drum major first brings the mace to the carry and cuts the right arm to the side, then signals the conductor to salute by rolling the mace once on the left foot (Left, Right). Both the conductor and the drum major salute on the following left foot. (See Massed Bands Salute Coordination in Section 5.)

16. To end the salute, the drum major signals the conductor to return to the position of attention by rolling the mace once on the left foot (Left, Right), returning the mace to the carry. Both assume the position of attention on the next left. They both swing arms on the following left foot, and the drum major can resume rolling the mace. The conductor observes the drum major's movement out of the corner of his eye.

SALUTING ON THE MARCH IN SLOW TIME

17. Occasions of having to salute while marching in slow time are rare. In slow time, the drum major signals the conductor to salute by rolling the mace once on the left foot. If doing the state walk (Section 5), the drum major brings the mace to the carry position on a left foot and cuts the right arm to the side on the next right foot. The drum major rolls the mace once on the next left foot and they both salute on the following left foot.

18. To end the salute, the drum major signals the conductor to return to the position of attention by rolling the mace once on the left foot. They both assume the position of attention on the following left foot. The drum major can then resume the state walk.

SECTION 4

BAND FORMATIONS AND MANOEUVRE

GENERAL

1. A band's parade presence, efficient manoeuvre, and coordinated interaction with other parading units contribute immensely to the success of a parade or ceremonial occasion. Parade procedures and techniques are described in Section 6.

BASIC BAND FORMATIONS

2. Bands shall be formed up in three or more files. The normal interval between files and distance between ranks is equivalent to two 75 centimeter paces. When the depth of a band exceeds the frontage by more than three ranks, the frontage will normally be increased by one file to maintain a balanced rectangular formation (see Figures 14-4-1 to 14-4-4). While drill positions are specified in the accompanying Figures, conductors and drum majors may adopt other positions according to circumstances and the nature of the duty.

3. Bands with frontages of four or less files shall dress by the right, except when changing direction (wheeling) to the left. Bands with frontages of five or more files shall dress by the centre file, except when changing direction to the left or right. Occasions may arise when the directing flank is changed while maneuvering.

4. A band should be sized by instrument rank with shorter members in the center files and taller ones in the outer files, taking instrumentation into account. Where possible, the centre files should be tiered from shorter members in the front to taller ones at the rear. This will aid in viewing control signals and executing manoeuvres.

5. To meet musical requirements, band members shall be detailed to specific positions before falling in:

- a. in general, military band formations shall be designed for balanced sound projection from all instruments;
- b. in corps of drums and naval bands utilizing drum ranks, it is customary for the drummers to form the front ranks; and
- c. in pipes and drums bands, drummers customarily form the rear ranks.

6. When brass-reed bands and corps of drums and / or pipes and drums are combined, the formation shall be designed to meet projected parade requirements, e.g., concert pieces, the necessity to break off sub-formations during the parade, or the hand-over of music from one band to the other. If no other criteria apply, it is customary for corps of drums to parade their

drums in the front ranks of the combined bands and their bugles or fifes in the rear ranks, and for pipers to form the rear ranks for visual effect. In foot guard regiments, the entire corps of drums and fifes customarily forms the rear ranks of the combined bands.

7. A Scottish or Irish regiment/battalion, on its own parades, may parade its pipes and drums in front of a brass-reed band when the two are combined, as may a light infantry or rifle/voltigeur regiment parade its buglers in similar formation.

8. When combined or massed, bands take precedence within the larger band formation as would their allocated environment, branch, regiment, unit on parade unless there are clear and obvious reasons to do otherwise (see A-AD-200-000/AG-000, Honours, Flags and The Heritage Structure of the Canadian Forces soon to become A-DH-200-000/AG-000; The Heritage Structure of the CAF, Chapter 1, Section 1). The parade commander or chief warrant officer should be advised in the technical aspects by the principal director of music, bandmaster, drum major, or pipe major.

ORDERING A BAND ON PARADE

9. The drum major shall take up position, usually three paces distance from where the front rank will stand, and give the command, BAND, MARKER. The designated marker comes to attention and marches forward, halting three paces in front of and facing the drum major. The drum major then gives the command BAND, FALL – IN. The rest of the band members come to attention, and fall in on the marker, remaining at the position of attention. If time and circumstances permit, the drum major will give the command to dress (either RIGHT – DRESS or INWARDS - DRESS depending on the frontage), dress the band and then give the command EYES – FRONT. Musicians do not take a step forward when dressing. Pipes and drums, unless otherwise directed, dress on the pipe major. The same procedure applies to combined and massed bands with participating drum majors spread evenly across the front of the bands to the right and left of the principal drum major. When bands are massed, musicians take up their own dressing when ordered.

10. When the band has fallen in, the conductor shall fall in. The drum major shall bring the band to attention (if not already at attention), salute if the conductor is an officer, report the band present and ready, and take up their post, normally on the right flank of the front rank should the conductor adopt the conducting position in front of the band.

DISMISSING A BAND ON PARADE

11. The command DIS – MISS signifies the completion of a parade or other duty. The band shall be at normal attention when dismissed. If the director of music is with the band, the drum major shall salute the officer before dismissing the band.

12. On the command DIS – MISS, band members shall turn to the right, observe the standard pause, salute with the hand if an officer is present, observe the standard pause, and march off independently from the place of parade in quick time. Musicians holding instruments that require two hands to hold will not salute.

13. When a band is one component of a larger parade, a director of music might fall out when the other officers are ordered to do so. The drum major would not salute at this point, but would salute (as would all band members) when the parade is ordered dismissed, if officers are still present.

14. If other units or sub-units do not dismiss from the general parade ground, but instead march off to their own parade grounds for dismissal, the band might play them off before themselves being dismissed.

WHEELS

15. When bands wheel or countermarch, drum majors must remain conscious of band frontages and depth and their own distance in front and be prepared to step short in order to avoid accordion effects. In a wheel, each band member wheels around the circumference of a circle following the path of the drum major as indicated by the visual signal (see Figure 14-5-25 and 14-5-26):

- a. the front rank shall wheel at exactly the same point as the drum major and the remaining ranks shall march straight to their front and wheel at exactly the same point as the front rank, covering the same ground;

- b. the inner files shall step short and close up to the rank in front of them while the outer files shall step out, without altering the cadence, to enable the ranks to wheel in line without losing their dressing;
- c. dressing is maintained by the inner flank. The speed of the wheel is governed by the ability of the outer file to keep pace by stepping out. While heads shall be kept to the front, musicians in the outer file glance inwards and the remainder glance outwards from the corner of the eye to maintain correct dressing.
- d. the inner file controls the pivot point thus keeping the band from shifting away from the pivot point. To avoid sidestepping, each rank maintains the interval between the left and right files. The interval between files must always be dressed to the inside and the musician must align the inside shoulder of the musician in front, already in the wheel, with the buttons on their tunic to avoid fish tailing;
- e. the drum major and the front rank, after completing their wheel, must step short for at least five paces in order to provide time for the rear of the band to complete the wheel and to avoid an accordion effect. Once the entire band has completed the wheel, each rank resumes the normal pace, dressing, and distance front to rear, following the drum major in the new direction; and
- f. if the band is halted or ordered to mark time when only a part of the members have wheeled into a new direction, those who have not yet wheeled will cover off on those who have, moving to their places by the shortest route.

16. When wheeling in quick time without playing, the disengaged arm is swung normally. When it is desired to wheel less than 90 degrees (a partial wheel), the drum major's arm signal is dropped when the front rank is facing the required direction.

STANDARD COUNTERMARCH

17. The standard countermarch is used when one or more bands are required to retire (change the front without halting). All files countermarch (wheel short round) to the right using four paces to turn about (see Figure 14-4-5). Front rank musicians counter to the right on the spot where the drum major has wheeled about, the remainder following suit rank after rank. Subsequent ranks begin to countermarch when they are right shoulder to right shoulder with the musician who was in front of them. The front rank must step short after clearing the rear rank of the band in order to avoid an accordion effect.

18. When countermarching while the band is playing, large instruments are brought down and in front of the body while turning about; others continue playing. Heads are not lowered. If not playing, in quick time the right arm is cut to the side at the point of turning about and thereafter swung normally.

19. The centre marker musician may be detailed to raise their instrument for a few paces and lower it smartly at the spot where the drum major has wheeled about as a signal to all in the front rank to counter to the right in unison.

SPIRAL COUNTERMARCH

20. The spiral countermarch (files converging from both flanks) is used when a small to medium size band is required to advance toward its rear, while maintaining its original directing flank and personnel positions, without using the space required for a double wheel (see Figures 14-4-6 and Figure 14-4-7):

- a. the front rank of the band begins the spiral countermarch on the centre marker's signal when the drum major passes through the rank in the opposite direction. Subsequent ranks wheel in the same direction as the musician in front of them;

- b. in bands with an even number of files, all files to the right of the drum major wheel to the left, and all files left of the drum major wheel to the right, as illustrated in Figure 14-4-6. In bands with an odd number of files, the same procedure is followed; the centre file wheels to the right (countermarches normally), as illustrated in Figure 14-4-7. In both cases, the left files wheel on the outside of the right files;
- c. when countermarching in quick time without playing, the disengaged arm is swung normally;
- d. musicians, while playing, should not lower heads when wheeling short round in the countermarch – music and instruments considered; and
- e. the front rank must step short after clearing the rear rank of the band in order to avoid an accordion effect.

SPECIAL WHEELING MANOEUVRES

21. During formation parades and ceremonies like Trooping the Colour, bands, drums and pipes may be massed, so increasing their frontage and depth to the extent that wheeling normally would take time and detract from the overall efficiency of the parade.

22. The following manoeuvres allow massed bands to change direction efficiently, within time and space constraints:

- a. Pivot Wheel - bands wheeling off the line of march, e.g., opposite a saluting base, to make way for troops coming up behind; and
- b. Spin Wheel - bands wheeling from the halt within a restricted space.

23. **Pivot Wheel.** Essentially, the large band pivots on the centre of its front rank. On a rehearsed wheel signal given by the principal drum major:

- a. the outer half of the band executes a normal wheel, its front rank pivoting on the centre musician of the front rank. Musicians in the inner half of the band stop their forward motion and begin marching backwards while still facing their front, pivoting on the centre musician of the front rank;
- b. musicians on the side wheeling normally continue to do so. Those on the other side where front rank musicians are marching backwards have to turn and face the rear in sequence as they begin to crowd into the rank in front of them. Those near the front of the band have to turn 180 degrees about, but those nearer the back can anticipate the pivot wheel occurring to their front and can turn at a 45 degree angle and move diagonally across the back of the band; and
- c. once the front rank has pivoted 90 degrees (achieved its new direction) each rank in succession faces the front and covers off at a normal two pace distance. The principal drum major then gives the forward signal and the band steps off.

24. **Spin Wheel.** Essentially, the large band wheels on its centre. Typically, a spin wheel is executed during a Trooping the Colour ceremony after the massed bands have turned about, backs to the saluting base, awaiting the command of the Lieutenant of the Escort to troop the Colour in slow time.

25. In the example below, massed bands wheel to the left, during which manoeuvre musicians in the outer (right) half of the bands face their front while those in the inner (left) half face the opposite direction. Musicians march and side-step while playing, with those closer to the centre taking very small steps. Directors of music positioned within the massed bands assist control.

26. Before attempting this manoeuvre, the distance between ranks must be decreased to one pace, vice the normal two.
27. On the command SLOW - MARCH, or on the principal drum major's visual signal to wheel (see Section 5):
- a. the right half of the massed bands wheels to the left as in normal squad drill, pivoting on the centre musician of the front rank, until the right half of the front rank reaches its new alignment, whereupon they mark time and the rear files of the right half cover off;
 - b. musicians in the left half of the bands (the half on the directing flank) execute four-beat about turns to the left, as follows. The front rank turns 90 degrees to the left (except the left-most musician of the front rank who executes a 180 degree turn to the left). The rear rank of the band executes a four-beat turn, 90 degrees to the right (except the right-most musician in the rear rank who remains facing the front);
 - c. the right half of the band continues to face its front;
 - d. on beat five all musicians step off. The large band now pivots on its centre, the musicians near the corners of the band moving in toward the centre so that the shape of the band changes from square to oval shaped. Inner musicians (those not in the front or rear ranks or in the two outside files) pivot to the left and manoeuvre around the centre musicians who are taking very short steps either to the left or to the right;
 - e. as the band pivots to the left, the four corner musicians start to move outward and this indicates to the remaining musicians that the bands are coming close to pivoting 90 degrees. As musicians see the corner players move out they begin to cover off, half facing the front (those who did not turn about initially) and half facing the rear (those who did turn about initially). During the process of covering off, the centre and outside files now dress back to normal two pace distances between ranks, all other musicians dressing on them;
 - f. once covered off, the half of the band which turned about initially executes a four-beat turn 180 degrees to the right on a double tap from the bass drum, or on an elevated baton signal from a designated director of music or bandmaster positioned within the band, bringing the whole of the massed bands and drums facing the same way; and
 - g. once all musicians are facing the front, the principal drum major then gives the forward signal and the massed bands step off in the new direction.

SECTION 5
V
VISUAL AND AUDIBLE
CONTROL SIGNALS AND MACE DRILL

GENERAL

1. Control and coordination of manoeuvre and music combine visual signals with verbal commands and cautionary drum taps. Annex A contains drum signals for use according to occasion and circumstances.
2. The drum major is responsible for leading the band on the march and for controlling the drill movements, and the musical action (where it is not practical for the conductor or pipe major to do so), of the band during parades. When there are multiple drum majors on parade, one shall be formally appointed principal drum major to coordinate and control the actions of combined and massed bands and of the other drum majors, all of whom shall signal in unison.
3. The drum major's parade staff or mace and a shorter parade cane are illustrated in Figure 14-5-1.
4. Brass-reed bands, corps of drums, trumpets, bugles, and pipes and drums bands shall all use the same standard mace drill and visual signals during military performances.
5. For optimum viewing of control signals, a band should be sized by rank with shorter individuals in the centre files and taller individuals in the outer files, instrumentation considered.
6. Since performing musicians must concentrate on their music and the route ahead, a cautionary "double-tap" on the bass or snare drum is normally used to draw band members' attention to the drum major's visual signals. However, musicians must endeavour to watch the drum major for signals just as they would watch a conductor.
7. Bugle majors of light infantry, rifle and voltigeur regiments may use a shorter staff – a parade cane – in lieu of a mace.
8. In the absence of a trumpet major, drum major or bugle major, the conductor shall lead the band on the march using rehearsed baton and hand signals similar to those used with the short parade cane (paragraph 30, below). Trumpet majors of units with mounted traditions may use corresponding hand signals.

DRUM MAJOR - STANDARD MACE DRILL POSTURES AND MOTIONS

9. Standard mace drill positions for all types of bands are illustrated in Figures 14-5-2 to 14-5-31. Movement of the mace from one position to another shall normally be by the most direct route. The standard pause between movements is one beat of quick time (i.e., movements occur on every second beat). When marching in quick time the disengaged arm is swung waist high. Movements of the mace are normally executed on successive left feet except where a signal is held over several paces so that musicians may better assimilate its meaning.

ATTENTION, STAND AT EASE AND STAND EASY

10. **See Figure 14-5-2.** In the attention position the right elbow is kept well into the side, the head of the mace slightly forward of the right shoulder. When the drum major stands at ease from the attention position, the mace is not moved. When the drum major stands easy, the mace is centred vertically in front of the body, ferrule on the ground equidistant between the feet in a line with the small toes, elbows into the sides, hands gripping the staff just below the head, left hand over the right, fingers closed around the top of the staff, thumbs crossed behind. The body is relaxed in place.

THE CARRY

11. The carry position is the initial stage of many other movements.
12. **Carry Position at the Halt (Figure 14-5-2).** From the halt (attention) position, the mace is brought to the carry position in two drill movements. First movement – cant the mace across the body and meet it with the left hand covering the belt buckle. Grip the mace with the left hand at the point of balance holding it between the thumb and first two fingers. Second movement – after the appropriate pause, cut the right arm to the side.
13. **Carry Position While Marching (Figure 14-5-3).** When the band is playing on the march, the drum major shall adopt the carry position. The subsequent action of the left arm moving the carried mace up and down diagonally across the body is referred to as rolling the mace.
14. When stepping off from the halt position (attention), the mace is moved to the first position of the carry as the left foot goes forward and is held in that position with both hands (Figure 14-5-4). On the final beat of the rolls (left foot), the right arm is cut to the side and as the next left foot goes forward the right arm is swung to the front, and the mace is lowered down across the body so that the left hand is in line with the left hip. As the right foot goes forward, the right arm is swung to the rear and the carried mace is rolled diagonally across the body between the left hip and the right breast, maintaining the correct angle of the mace (across the body) with a firm grip. The motions with both arms are continued while music is being played (see also Walking the Mace, below.)
15. The drill for stepping off and marching in slow time is the same as for quick time, except that the mace is held motionless at the carry (Figure 14-5-5). (See also the State Walk, below.)

SALUTING

16. **Saluting at the Halt (Figure 14-5-6).** The salute at the halt is executed as normal (see Chapter 2), with the mace at the carry. On completion of the salute, the mace is returned to the position of attention using drill movements described in paragraph 12 in reverse order.
17. **Saluting on the March (Figure 14-5-6).** To salute to the right or left, first cut the right arm to the side and bring the left hand to cover the belt buckle as the right foot comes to the ground. Salute on the left foot and maintain the salute until the band has passed the saluting point. On completion, return to the first position on successive left feet, with arms moving. Saluting is seldom required when marching in slow time (see Section 2, Compliments, Section 3, Saluting on the March, and Massed Bands Coordination Signals, below).

THE TRAIL

18. The mace is normally trailed when the band is not playing, and when marching at ease.
19. **Stepping Off Into the Trail (Figure 14-5-7).** When stepping off from the halt (attention), the mace is carried slightly upwards, then into the position of the trail, mace down at the right side, parallel to the ground, head to the front, the staff gripped with the fingers around it and thumb extended along it. When marching in quick time, both arms are swung front to rear to waist belt height. When marching in slow time the arms and trailed mace are held motionless at the sides.
20. **Changing from the Carry to the Trail in Quick Time and in Slow Time (Figures 14-5-8 to 14-5-10).** As the right foot goes forward the right arm is cut to the side, and if rolling the mace the left hand is brought to cover the belt buckle at the same time. On the next left foot, the mace is grasped with the right hand just below its head. On the next left foot, the left arm is cut to the side and the mace is brought to the trail position.

21. **Changing from the Trail to the Carry in Quick and Slow Time (Figures 14-5-11 and 14-5-12).** To change from the trail to the carry, drill movements described in paragraph 20 are carried out in reverse order.

HALTING

22. **Drum Major Halting When Marching at the Carry.** When halting, the mace is retained at the carry (left hand covering the belt buckle); then, depending on the situation, it is brought to the normal position of attention after the appropriate pause.

23. **Drum Major Halting When Marching at the Trail (Figure 14-5-13).** As the drum major bends the right knee to halt, the mace is simultaneously brought from the trail directly up to the normal position of attention.

MARCHING A BAND OFF PARADE

24. Following a parade or other duty, bands will be dismissed normally along with other parading sub-units (see Section 4). Where traditional drum beatings and bugle sounds constitute the focal point of a ceremony, e.g., Beating Retreat, it is customary for the drum major to request permission of the senior officer or dignitary for the band to march off parade with or without music according to the form of ceremony. The drum major will carry out this duty using the following drill:

- a. turn about to face the band. Stand them properly at ease, then turn about again;
- b. step off towards the senior officer or principal dignitary, adopting the trail directly and swinging both arms. If only a short distance, adopt the carry position when stepping off, and swing the right arm;
- c. on approaching the dignitary, bring the mace to the carry, keeping the left hand at the belt buckle, and swing the right arm;
- d. halt, salute, and request "Permission to march the band off parade, Sir/Ma'am,";
- e. on permission being granted, salute, turn about, step off adopting the trail, and return to the band. Adopt the carry and halt in front of and facing the band. It is not obligatory to adopt the carry prior to halting; an alternative is to halt at the normal position of attention direct from the trail; and
- f. order the band to attention, turn about and order the quick-march, and if not countermarching immediately, salute to the left or right in passing a saluting point as appropriate.

THE STATE WALK AND WALKING THE MACE

25. When marching to music, the state walk in slow time (Figure 14-5-14) and its quick time variant (Figure 14-5-15) may be used to add "éclat" to a ceremonial occasion.

26. **The State Walk (Figure 14-5-14).** On the command SLOW – MARCH, the mace shall be brought directly to the trail and carried in that position for the first six paces and then:

- a. first - as the seventh pace is being taken (left foot), bring the mace up, its head just in front of the right shoulder and place the tip of the ferrule on the ground at the same time as the right foot comes to the ground on the eighth pace;
- b. second - with a circular motion, bring the mace back across the body so that its head is in front of the left breast as the left foot reaches the ground;

- c. third - flowing from the previous movement, carry the mace out to the right to the full extent of the right arm as the next right pace is completed; and
- d. fourth - bring the mace up and forward in an arc and back down to the trail in one flowing motion, carry it there for two paces (left and right feet) and repeat the previous four movements starting as the next left foot comes forward. Thus, the complete movement sequence takes six paces in slow time and no pause will be made between the movements. Repeat the sequence as often as necessary.

27. **Walking the Mace in Quick Time (Figure 14-5-15).** When marching to music in quick time, the mace shall be brought to the trail and carried in that position for the first six paces if timed to coincide with a five-pace roll, or eight paces timed to coincide with two three-pace rolls and then the movements are the same as for the first three movements of the state walk in slow time but the left arm is swung throughout. Three movements complete the cycle which is repeated from the position of the right arm extended out to the right. Thus, the complete movement sequence takes four paces in quick time and no pause will be made between movements nor will the trail position be part of the movement sequence.

DECORUM

28. **Flourish.** Depending on custom and occasion, the drum major may flourish the mace while marching to music in quick time; among the recognized flourishes are spinning in either hand, and tossing the mace in the air. Mace flourishes shall not be executed while leading massed bands. Rolling the mace and walking the mace are not regarded as flourishes, nor is the state walk.

29. **Solemn Ceremonies and Funerals.** During a funeral procession, the drum major shall not flourish, roll or walk the mace which will be held motionless at the carry (the trail if marching a long distance) to complement the solemn mood and decorum of the occasion. The head of the mace is to be draped in black cloth along with the drums (see Chapter 11, Section 2, Table 11-2-2, Note 4).

PARADE CANE

30. In the normal attention and stand at ease positions, the cane's ferrule is on the ground beside the right toe. The standard positions and visual signals used with the longer mace serve also for the cane except for the trail when the cane is carried with the ferrule forward. When changing from the trail to the carry, the cane is spun so that it describes a circular motion up to the carry position, the cane head uppermost in readiness to present control signals as required. When the cane is brought down, it is brought down directly to the carry position, not dropped.

STANDARD VISUAL AND AUDIBLE CONTROL SIGNALS

31. The standard visual control signals used by all types of bands are illustrated in Figures 14-5-16 to 14-5-29. Audible signals from the drum section normally accompany mace signals (see Annex A). If the band is playing, the bass drum will play the audible signal. If the band is not playing, either the bass drum or snare drum will play the audible signal.

32. Unless otherwise stated, signals given on the march and when marking time are initiated from the carry position. Movement of the mace from one position to another shall normally be by the most direct route. Movements are executed gracefully and in tempo with the music being played. Only the Halt, Cease Playing and Change to Slow or Quick Time signals involve abrupt movement. At no time should it be necessary for a drum major to look at their mace, particularly when dropping it to the centre of the body.

33. The quick march is used as the standard for drill and manoeuvre except where otherwise described below.

STEPPING OFF AND MARKING TIME

34. The visual signal is the same for stepping off and for marking time (see Figures 14-5-16 and 14-5-17).

STEPPING OFF

35. The drum major may order the band to step off either verbally or visually. On receipt of a verbal command to step off, the band shall do so as for standard foot drill (Chapter 3).

36. The visual signal to step off is given from the carry position, at the halt (see Figure 14-5-16), or on consecutive left feet when marking time:

- a. the right hand is extended down to grasp the staff just below the midway point;
- b. the mace is raised with both hands to the horizontal, to chin level, the left hand reversed to grasp the staff near its head so that the palms of both hands are to the front, fingers curled over the staff;
- c. after a pause, the horizontal mace is raised above the head, arms fully extended;
- d. the drummer shall play a cautionary “double-tap” on a left foot beat, a signal for all band members to look at the drum major’s signal; and
- e. after a mental check pace (right foot), the drum major brings the mace down to shoulder level (executive) on the left beat as a signal to step off (or mark time). As the band steps off on the next left foot, the drum major, on successive left feet, brings the mace directly to the carry position.

37. Intricacies with this movement:

- a. **Band Not Playing - At the Halt.** The drum major brings the horizontal mace down to shoulders level, band members observe a mental check pace (right foot), and step off on the next left foot;
- b. **Band Not Playing - Marking Time.** The drum major brings the horizontal mace down to shoulders level on the left foot, band members take a check pace with the right foot and step off (resume marching forward) on the next left foot;
- c. **Band Playing - At the Halt.** The drum major brings the horizontal mace down to shoulders level on the first beat of a bar of music, band members observe a mental check pace (right foot), and step off on the next left foot (continuing to play); and
- d. **Band Playing - Marking Time.** The drum major brings the horizontal mace down to shoulders level on the first beat of a bar of music, band members take a check pace with the right foot and step off (resume marching forward) on the next left foot (continuing to play).

MARKING TIME

38. On receipt of a verbal command to mark time, the band shall do so as for standard foot drill (Chapter 3).

39. The visual signal to mark time is the same as for stepping off (see Figure 14-5-17). Bands will not normally be signalled to commence marking time from the halt unless pre-arranged (see Parade Procedures and Techniques, Section 6). Assuming the band is marching in quick time, the mace is at the

carry position. As the right foot goes forward, the right arm is cut to the side and at the same time the left hand is brought to cover the belt buckle. Working on consecutive left feet:

- a. same as 36.a.;
 - b. same as 36.b.;
 - c. same as 36.c.;
 - d. same as 36.d.;
 - e. after a slight preparatory movement of the raised mace (an “upbeat” on a right foot beat), the drum major brings the horizontal mace down to shoulder level on the next left foot. Band members take a check pace with the right foot, then a half step with the left foot and then bring the right foot into the left in a straight-legged manner, not scraping the ground, and commence marking time on the next left foot (i.e., when the mace is brought to shoulder level on a left foot, the count is RIGHT – LEFT – IN (RIGHT). When marching in quick time without playing, musicians simultaneously cut the disengaged arm to the side;
 - f. on the next left foot, band members commence marking time, bend the left knee as in standard foot drill (Chapter 3) and in tempo with music being played; and
 - g. on the following left foot / beat, the Drum Major brings the mace to the carry position.
40. When marking time, the mace is at the carry. If marking time for only a short period of time before stepping off again, the mace can remain at chin level, before being raised again in preparation for the step off signal.

HALTING

41. The same visual and audible signal and process, initiated from the carry position, are used to halt the band when marching or when marking time, either in quick or in slow time (see Figure 14-5-18).
42. Whenever possible, bands should mark time prior to being halted, particularly while playing.
43. On receipt of a verbal command to halt, the band shall halt as detailed in Chapter 3.
44. The visual signal to halt is given from the carry (Figure 14-5-18):
 - a. as the right foot goes forward, the right arm is cut to the side and at the same time the left hand is brought to cover the belt buckle;
 - b. first, on a left foot, extend the right hand down to grasp the staff at the bottom of the chain;
 - c. second, on the next left foot, with the left hand, push the mace across the body to a vertical position at the right side, the left hand at the bottom of the right shoulder, keeping the head of the mace close to the shoulder;
 - d. third, on a left foot, with the right hand, raise the mace vertically above the head to the full extent of the right arm, ferrule close to the forearm. Cut the left arm to the side. The drummer shall play a cautionary “double-tap” on the left foot, a signal for all band members to look to the drum major. The drum major’s left arm is not swung;
 - e. fourth, on a left foot, the mace is dropped to the right of the body on a left foot and caught just below the mace head (this drop movement is equivalent to a verbal command to halt). The

movement should be preceded by a slight preparatory motion (“upbeat”). The band takes a pace with the right foot, a pace with the left foot, and halts on the next right foot; and

- e. the drum major, after an appropriate pause, adopts the normal position of attention.

COMMENCE PLAYING

45. The verbal command for a band to commence playing has two variants. If the requirement is for the band to commence playing and step off immediately, the command is BAND, BY THE CENTRE (or BY THE RIGHT), QUICK – MARCH, or SLOW – MARCH. If the requirement is for the band to commence playing and remain stationary, the command is BAND, AT THE HALT, ROLLS, QUICK – MARCH, or SLOW-MARCH.

46. The visual signal from the drum major for commence playing is an inverted mace (see Figure 14-5-19 and 14-5-20). From the halt position, the commence playing signal shall be displayed as follows:

- a. bring the mace out in front of the body, centred and perpendicular. At the same time, the left hand is brought to the front, grasping the shaft of the mace below the right hand (approximately 30 cm); the right hand grip does not change;
- b. the mace is inverted forward and up, the back of the right hand in front of the throat, mace perpendicular to the ground, ferrule uppermost. The left hand can assist raising the mace, increasing its forward momentum by pushing the mace forward before cutting that arm to the side; and
- c. see drum signal / rolls, below.

47. To display the visual signal for commence playing on the march (Figure 14-5-20):

- a. the mace is first brought to the carry position;
- b. the mace is brought out in front of the body, centred and perpendicular. At the same time, the right hand is brought to the front, grasping the shaft of the mace just below the head in an overhand grip (palm inwards);
- c. same as 46.b.; and
- d. same as 46.c.

48. **Returning the Mace to its Original Position.** If the band is at the halt, the drum major returns the perpendicular mace to the centre of the body and then to the attention position. If on the march, in quick time the mace is brought down to the carry on the first beat of the second set of rolls; in slow time on the “third” beat (next left). In both quick and slow time, the mace is brought down perpendicular, centred on the body, and caught at the point of balance in the left hand. On the next left, the mace is brought to the carry and the right arm is cut on the next left pace. If marching in quick time, the drum major swings the right arm and rolls the mace at the commencement of the music.

49. The first movement in bringing the mace down from the inverted position may need to be anticipated, especially when using a heavier mace. The downward movement may have to begin slightly before the left foot hits the ground, the point being that the mace is caught in the left hand as the left foot hits the ground.

50. **Drum Rolls.** On receipt of a verbal command or mace signal to commence playing, the drum section shall play rolls as in Figure 14A-1 if in quick time, or two bass drum beats as in Figure 14A-2 if in

slow time. If already playing a drum pattern, drummers will conclude the pattern prior to starting the drum rolls or bass drum beats.

51. The rolls or bass drum beats establish the correct cadence and cue instruments to be moved in unison from carrying positions through intermediate positions, to playing positions at the beginning of the second part of the drum rolls (see Section 2 for details).

CEASE PLAYING

52. At the halt from the attention position, the drum major displays the cease playing signal (see Figure 14-5-21) as follows:

- a. the right hand is dropped 30 cm down the staff;
- b. the mace is lifted to nose level, parallel with the ground;
- c. the left hand reaches up to grasp the staff at the top of the chain and the right hand is slid over to the right to grasp the staff at the bottom of the chain, palms of both hands forward, fingers curled over the staff;
- d. the right arm is extended out to the right, the mace raised to an oblique position to the full extent of the right arm, to be at an angle of 45 degrees with the horizontal, the head of the mace directly above the drum major's head, the mace at a right angle to the arm. The left hand is cut to the side;
- e. the bass drummer shall play two double-taps (see Figure 14A-4), for cease-playing, a signal for all band members to look to the drum major's signal;
- f. at an appropriate point in the music the drum major cuts the music by bringing the right hand to the face in a semi-circular movement, the forearm and mace vertical. Although not always possible, the drum major should try to time this signal to coincide with the end of a musical phrase. Musicians cease playing when the drum major cuts the music; and
- g. after the cut-off, on the next imaginary left foot, the mace is allowed to drop perpendicularly through the right hand to the centre of the body, grasped just below the head of the mace, and, after an appropriate pause, the position of attention is resumed.

53. On the march and when marking time the cease playing signal is initiated from the carry (Figure 14-5-22). Working on consecutive left feet:

- a. the right hand is extended down to grasp the staff at the bottom of the chain;
- b. the mace is lifted to nose level, parallel with the ground;
- c. same as 52.c.;
- d. same as 52.d except that when on the march in quick time the left arm is not cut to the side, but is swung in time with the music;
- e. same as 52.e;
- f. the right hand is brought to the face in a semi-circular movement (normally on the second left foot after the second double-tap), the forearm and mace vertical; and

- g. on successive left feet, (left) the mace is dropped to the centre of the body and (left) moved directly to the trail, or to the carry if marking time. If being brought directly to the trail, the mace is grasped at the point of balance as it is dropped.

54. When drum majors drop their maces, instruments are brought down to the intermediate position and to the carrying position on successive left feet and disengaged arms are swung if marching in quick time. If music is to be changed, it shall be changed in the intermediate position (see Section 2, paragraph 9).

SIMULTANEOUS CEASE PLAYING WHILE HALTING

55. There may be occasions where it will be necessary for the band, while on the march, to simultaneously cease playing and halt. In order to effect this "double" event, the drum major shall execute the following (see Figure 14-5-23):

- a. as an intermediate position, the drum major extends the left arm up at a 45 degree angle to the horizontal as the left foot comes to the ground and with the right hand raises the mace to a perpendicular position above the head (like the normal halt signal). The left hand is extended open palmed forward, as for a salute;
- b. the bass drummer shall play two double-taps (see Figure 14A-4);
- c. the left arm is cut to the side indicating the executive "halt"; and
- d. the normal mace cut-off signal is given, followed by the last pace of the 4-pace halt sequence. After the standard pause, the mace is dropped to the side.

CHANGING MARCH TEMPO

56. On occasion, troops will be required to change the cadence of the march whilst continuing to march, e.g., from slow to quick time. Normally this will be executed on word of command (see Chapter 3 for detail).

57. There may be occasions where a band will be required to change cadence of the march whilst continuing to march, and while playing. As such, the change must be executed via visual signal as words of command would not be heard. The visual signal to change marching tempo from quick to slow and vice versa is illustrated at Figure 14-5-24.

58. From the carry position, the mace is pushed forward vertically and grasped with the right hand just above the left. To signal the change to the march tempo:

- a. first position. With the right hand the mace is pushed upwards to a horizontal position above and to the right of the head, right arm fully extended, the ferrule of the mace to the front; then
- b. second position. The right arm is bent abruptly, lowering the mace almost to shoulder level, while maintaining its original plane; and
- c. on the next left foot, the band changes marching cadence from quick to slow or vice versa.

59. On observing the visual signal, the drummer shall play a cautionary double-tap. The drum major's abrupt movement from the first position to the second position (on the left foot) shall be acted upon in the same manner as for the verbal command to march (Chapter 3), except that the change of cadence is to be executed on the next left foot. The drum major returns the mace to the carry position.

Notes:

1. If music is not being played, the drum major may adopt the first position directly from the trail.
2. Parade marching tempos once set shall be maintained consistently, see Section 6.

WHEEL SIGNALS

60. **Right Wheel Signal (Figure 14-5-25).** From the carry position and on consecutive left feet throughout, the drum major signals a right wheel as follows:

- a. the right arm is cut to the side;
- b. the right forearm is brought across the chest, elbow raised, forearm parallel to the ground;
- c. the right arm is extended out to the right in a graceful semi-circular movement, the first two-fingers of the hand pointed, hand just above shoulder level, at the same time, the head and eyes are turned to the right; and
- d. on completion of the wheel, or partial wheel, and new alignment attained, head and eyes are returned to the front, the right arm is dropped to the side and the drum major continues to march at the carry. The trail may be adopted.

61. **Left Wheel Signal (Figure 14-5-26).** From the carry position and on consecutive left feet throughout, the drum major signals a left wheel as follows;

- a. the right arm is cut the side;
- b. the mace is transferred to the right hand, left hand dropped away;
- c. on the next left foot, the left forearm is brought across the chest, elbow raised, forearm parallel to the ground;
- d. the left arm is extended out to the left in a graceful semi-circular movement, the first two-fingers of the hand pointed, hand just above shoulder level, at the same time, the head and eyes are turned to the left; and
- e. on completion of the wheel, or partial wheel, and new alignment attained, head and eyes are returned to the front, the left arm is dropped to the side, the mace is transferred to the left hand and the drum major continues to march at the carry. The trail may be adopted.

62. Drum majors should step short in the wheel until such time as they estimate that the entire band has completed the wheel, thereby ensuring that the whole movement is completed unhurriedly and in good order.

STANDARD COUNTERMARCH SIGNAL AND ACTION

63. To execute a standard countermarch (see Figure 14-5-27), from the carry position and on consecutive left feet, the drum major completes the following:

- a. the right arm is cut to the side;
- b. on the next left foot, the right hand grasps the mace above the left hand;
- c. on the next left foot, the right arm is extended straight out to the right from the body, with the mace perpendicular to the ground (ferrule pointing down);

- d. the mace is brought in front of the body and grasped by both hands (right above left) with the mace canted;
- e. the right arm is cut to the side;
- f. the right foot is brought in to the left, straight-legged;
- g. the drum major countermarches to the right, four paces short-round;
- h. if the frontage of the band is an odd number, the drum major heads to the left (right shoulder to right shoulder) of the centre marker. If the frontage is an even number, the drum major may head for the space between the centre files; and
- i. the drum major marches through the band in quick time, mace at the carry or if there is insufficient spacing bring in the ferrule to the left in front of the body, and the right arm is swung. The mace is not rolled until the drum major emerges through the rear rank of the band, clear of the musicians.

SPIRAL COUNTERMARCH SIGNAL AND ACTION

64. To execute a spiral countermarch (see Figure 14-5-28), from the carry position and on consecutive left feet, the drum major completes the following:

- a. the right hand is extended down to grasp the staff at the bottom of the chain;
- b. with the left hand the mace is pushed across the body, to a vertical position at the right side, the left hand at the bottom of the right shoulder, keeping the head of the mace close to the shoulder;
- c. with the right hand the mace is thrust up vertically and centred. At the same time, the left hand is removed to grasp the mace just above the right hand, both hands above chest level;
- d. using both hands, the mace is rotated so that the head describes a circle in the air (at least two rotations);
- e. to bring the mace down, it is allowed to slide through the hands until the left hand can grasp it at the point of balance;
- f. the mace is brought to the carry and the right arm is cut to the side. At the same time, the right foot is brought in to the left, straight-legged;
- g. the drum major countermarches to the right, four paces short-round; and
- h. as per paragraphs 63.h. and 63.i..

PIVOT AND SPIN WHEEL SIGNALS

65. To signal the start of a pivot or a spin wheel (Section 4), the drum major inverts his mace and moves it in a circular motion, combining movement from commence playing and spiral countermarch signals.

MASSED BANDS COORDINATION SIGNALS

66. **Coordination Signals From the Principal Drum Major to Other Drum Majors.** When several bands of the same or different types are massed, their drum majors form a front rank, with the principal drum major, who controls the formation from a central position, positioned six paces in front of the drum majors rank. The format of the parade must be known by all of the drum majors beforehand. The principal drum major will give coordinating signals in order that all drum majors can work in unison to guide the actions of band members. Except where obvious, the following coordination movements are made only by the principal drum major, the remaining drum majors conforming to the standard mace drill.
67. **Common Coordination Signal (Figure 14-5-29).** The common coordination signal is the raising of the right arm to an angle of 45 degrees with the horizontal. This position is held for at least six paces to ensure that the signal is observed by all of the drum majors. The arm is dropped on the left foot and the desired movement started on the next left foot. When drum majors are advancing at the state walk and it is time to countermarch, mark time, or halt, the principal drum major raises his left arm while all continue the state walk motions. On dropping the arm, the desired signal or movement is initiated as rehearsed.
68. **Salute Coordination.** The principal drum major displays the common coordination signal, dropping the arm on the left foot. All drum majors go to the carry, if rolling maces, on the next left foot, and all salute together either right or left on the following left foot. To finish the salute, the drum major on the directing flank “pumps” his mace once to the front (left, right) and on the next left foot all drum majors cut their arms and on subsequent left feet either roll again or remain at the carry.
69. **Marking Time and Stepping Off.** If at the halt, musicians may expect to either step off, or take up marking time and step off.
70. **Marking Time From The Halt.** In the absence of a verbal command musicians will usually take up marking time before stepping off. Marking time can be rehearsed and “signalled” by the principal drum major adopting the carry and commencing to mark time, the other drum majors and the front rank of the band taking up marking time, which very quickly makes its way to the rest of the band (see Section 6).
71. **Stepping Off From Marking Time.** Maces are at the carry. When all musicians are marking time the signal to go forward will be the standard field signal; a full sweep of the right arm, fingers and hand extended, palm to the front, from rear to front, the hand passing close to the side, finishing above the head. The sweep will start on the beat of the left foot and finish on the right. The other drum majors will follow suit. The principal drum major will signal an “upbeat” on a right foot causing all drum majors to drop their hands on the left foot. The bands will step off on the next left foot.
72. **Halting On the March and When Marking Time.** The common coordination signal is displayed twice by the principal drum major; initially, with the right arm forward to get all maces into the halt position; and then, with the left arm forward to signal that maces be dropped together.
73. **Cease Playing at the Halt (Figure 14-5-30).** To warn the other drum majors that the signal to cease playing is to be given, the principal drum major circles the mace through 360 degrees twice (from the position of attention through the positions illustrated, then back to the position of attention, ferrule on the ground). On the second turn of the mace, an abrupt forward motion is made and on seeing this motion all drum majors drop their right hands 15 cm down the staves and lift their maces to nose level (as for standard cease playing). The principal drum major only then dips the mace (to a vertical position centred on the body) as the signal for the next movement and at the appropriate time swings the mace up above the head. As the principal’s mace is lifted from the dip to the “right arm extended, mace at 45 degrees” position, all drum majors lift their maces and execute the remaining movements in unison. For the music cut off, the principal drum major makes a slight upward motion with the mace causing all of the drum majors to signal the cut off. Musicians react appropriately. After a standard pause, maces are all dropped together and the attention position adopted.

74. **Cease Playing on the March.** The signal to cease playing on the march is preceded by the common coordination signal, given by the principal drum major, right arm raised and dropped on the left foot. After ceasing to roll maces, the cease playing movements are then executed, as above, by all on sequential left feet, the principal drum major dipping and subsequently making an upward motion with the mace at the appropriate moment, all signalling the cut-off in unison and then bringing maces back down to the carry, or to the trail. Musicians react appropriately. Obviously, the format of the parade must be known by all of the drum majors beforehand.

75. **Standard Countermarch.** When two or more drum majors are working together, in order for the massed band to execute a standard countermarch, the principal will give the normal standard countermarch signal (see paragraph 63). The non-principal drum majors will take the extension of the mace movement (as per paragraph 63.c.) from the principal drum major as their executive command to start the standard countermarch signal.

SECTION 6

PARADE PROCEDURES AND TECHNIQUES

1. Whenever possible, battalion / unit parades and reviews shall be supported by a band. Unless the form of the ceremony dictates otherwise, the band shall lead the unit on and off parade, and be positioned in the centre rear or on a flank of the unit on parade (Chapter 9, Section 1, paragraphs 20 to 26).
2. In order to maintain the momentum of a parade or ceremony, bands may reposition for the next phase while other participants readjust formations and take dressing.
3. When a unit is scheduled to march out of its barracks or lines, the drum major shall ascertain from the unit adjutant or chief warrant officer the route that the commanding officer wishes to take, and is responsible that it is followed. Troops marching behind a band should maintain appropriate distance in the event that the band is forced to halt or form unexpectedly.
4. On the line of march, combined bands can take turns playing so that there is continuous music. One band on ceasing to play can provide the introductory roll-off for the other in order to maintain the ordered tempo consistently throughout the length of the march or march past, regardless of types of bands or traditional marching tempos of some of the units on parade.
5. When playing one or more units past a saluting point, individual bands or combined or massed bands shall be pre-positioned opposite the saluting point (centre of the saluting base), or shall march up fifty paces in advance of the leading unit or sub-unit, wheel directly off the line of march and then countermarch so as to face the saluting point and halt leaving space for the troops to pass.
6. Units march past to their own authorized marches (see A-AD-200-000/AG-000, Honours, Flags and The Heritage Structure of the Canadian Forces soon to become A-DH-200-000/AG-000; The Heritage Structure of the CAF, Chapter 7). The band shall commence playing the appropriate march as soon as the leading unit or sub-unit advances on the saluting point, continuing to play until the rear of the unit has passed, changing to the next march as a following unit approaches. The band shall remain in position if there is to be a second march past, or step-off playing to follow the troops away from the saluting point, or re-position themselves for the next phase of the parade or ceremony. If a unit marches past a second time in the same tempo, but in a different formation, the band should play a neutral march.
7. During recruit training and rehearsals, bands or percussion sections may stress the strong beat on the left foot, but when troops have acquired the ability to distinguish the main pulse, the emphasis can be normalized. (See also Chapter 1, Section 1, paragraph 49.)
8. A band waiting alongside a parade route to lead approaching troops will have a drummer turn to face in their direction in order to obtain their cadence and step. If circumstances preclude drum beats or audible signals, e.g., positioning for a commemorative ceremony, the drum major turns to face the approaching troops and commences to mark time in their step and cadence. Musicians take up marking time with the drum major who signals the band to turn and step off at an appropriate distance in front of the approaching troops, with or without music.

ANNEX A TO CHAPTER 14

GENERAL

1. Standard drum signals are illustrated in Figures 14A-1 to 14A-4. Drum signals serve to reinforce or confirm visual signals, particularly on occasions when the latter might not be clearly seen or recognized by all band members. The bass drummer may act as an audible extension of the drum major's visual signals while maintaining a judicious balance between audible cues and the music being played. Drum taps need not and should not be routinely employed as executive commands.
2. Drum signals are used according to occasion and circumstances. On occasions such as during state and solemn ceremonies and funerals, the event commander, band conductor, or drum major may determine drum signals to be inappropriate to the tone and decorum of the occasion and order them not to be used. Bands shall routinely practice music and manoeuvre without the aid of drum signals.
3. Pipes and drums and corps of drums musicians shall be acquainted with and use the drum signals in this Annex. March tempos peculiar to specific types of units when on their own parades are explained in Chapter 3, paragraphs 6 to 8. Instructions for funeral duties, including processional tempos, are in Chapter 11, Section 2.

QUICK MARCH

4. When ordered to QUICK - MARCH, the drum section shall play the standard signal as illustrated in Figure 14A-1. Introductory drum rolls or beats may differ according to unit preference but shall be standardized when bands and drums and pipes of different units are combined or massed.

Figure 14A- 1



SLOW MARCH

5. When ordered to SLOW-MARCH, the bass drum shall play the signal as illustrated in Figure 14A-2.

Figure 14A- 2



STEPPING OFF

6. Upon recognizing the drum major's signal for the band to step off, the bass drum shall play Figure 14A-3. The band shall step off as indicated by the drum major.

Figure 14A- 3



MARKING TIME

7. Upon recognizing the drum major's signal for the band to mark time, the bass drum shall play Figure 14A-3. The band shall mark time as directed by the drum major.

HALTING

8. Upon recognizing the drum major's signal for the band to halt, the bass drum shall play Figure 14A-3, a signal for all band members to look to the drum major. The band shall halt as directed by the drum major. When and where appropriate, the drum major shall bring the mace down (on the left foot). Counting this left foot, the cadence is LEFT-RIGHT-LEFT-HALT.

CEASE PLAYING

9. Upon recognizing the drum major's signal for the band to cease playing, the bass drum shall play Figure 14A-4, a signal for all band members to look to the drum major. The drum major shall indicate the cease playing point when and where appropriate, normally on a left foot.

Figure 14A- 4

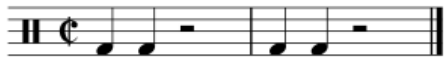

CHANGE OF CADENCE

10. Upon recognizing the drum major's signal for the band to change cadence of march (from slow to quick or quick to slow), the bass drum shall play Figure 14A-3, a signal for all band members to look to the drum major. The band shall change cadence as directed by the drum major.

**ANNEX B
TO CHAPTER 14**



Figure 14-2- 1 Drill Positions for Piccolo

						
CARRYING / ATTENTION	PLAYING	PLAYING (SIDE VIEW)	INTERMEDIATE 2	INTERMEDIATE 1	STAND AT EASE	STAND EASY

Figure 14-2- 2

Drill Positions for Clarinet and Oboe



Figure 14-2- 3 **Drill Positions for Bassoon**

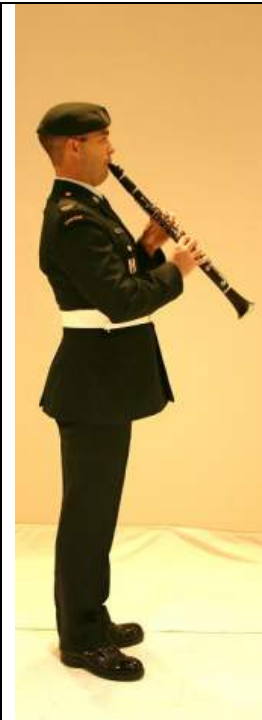

Figure 14-2- 4 **Drill Positions for Alto and Tenor Saxophone**

						
<p>CARRYING / ATTENTION</p>	<p>PLAYING</p>	<p>PLAYING (SIDE VIEW)</p>	<p>INTERMEDIATE</p>	<p>STAND AT EASE</p>	<p>STAND EASY</p>	<p>ALTERNATE STAND EASY</p>

Figure 14-2- 5

Drill Positions for Baritone Saxophone



Figure 14-2- 6

Drill Positions for French Horn



Figure 14-2- 7

Drill Positions for French Horn When Wearing Sword/Bayonet

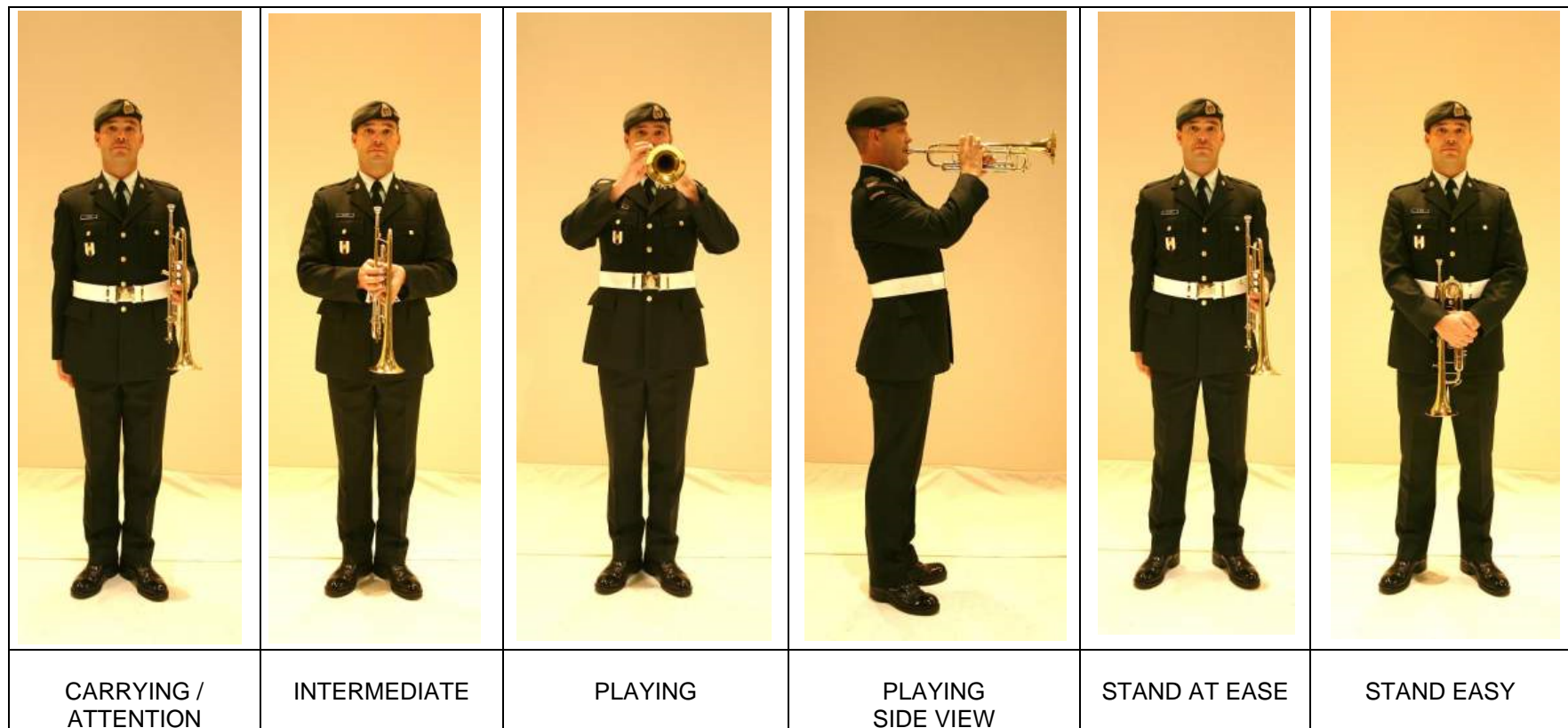

Figure 14-2- 8

Drill Positions for Trumpet



Figure 14-2- 9

Drill Positions for Trombone



Figure 14-2- 10 Drill Positions for Euphonium

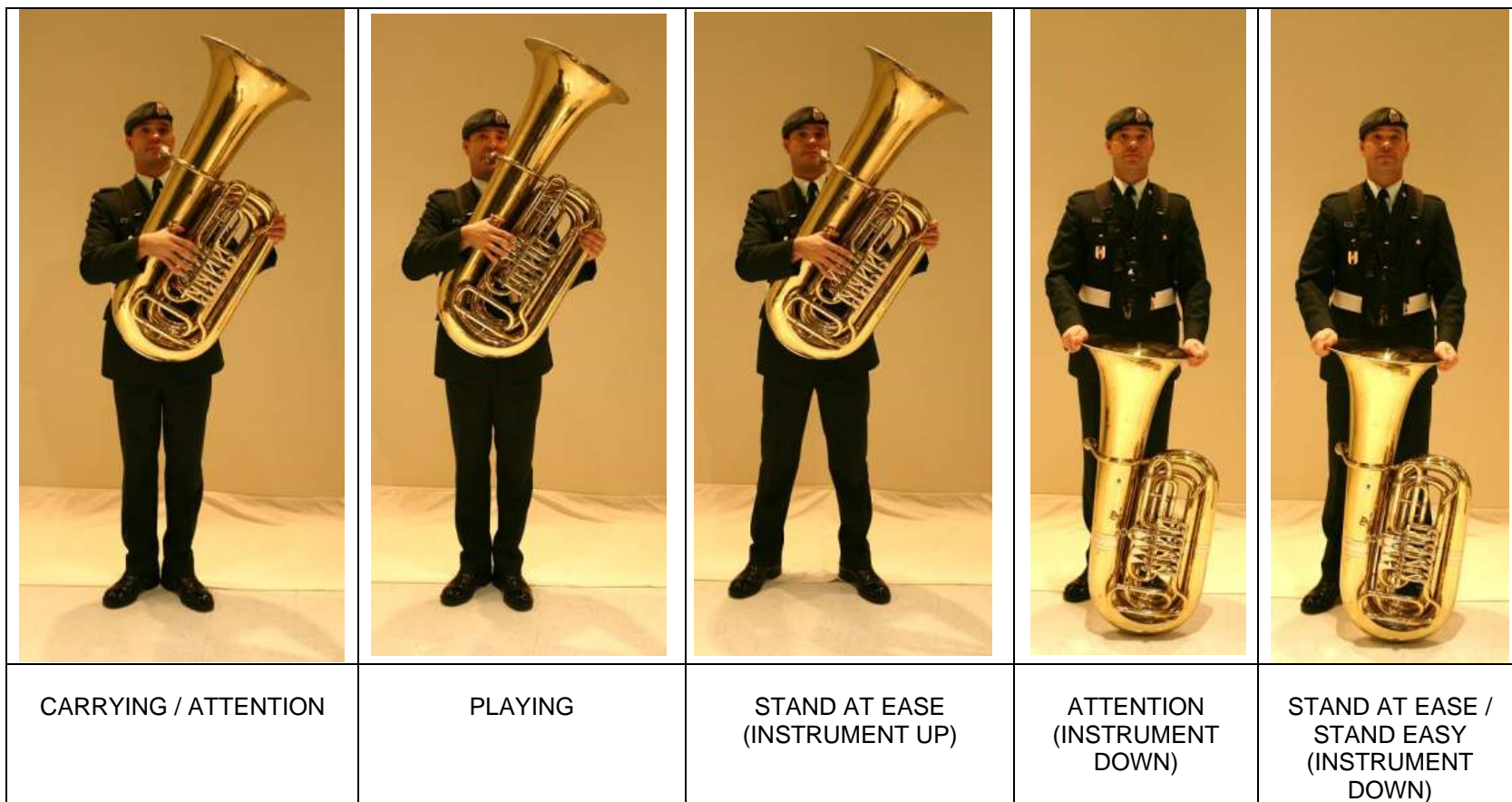

Figure 14-2- 11 Drill Positions for Tuba

			
<p>CARRYING / ATTENTION</p>	<p>CARRYING / ATTENTION (SIDE VIEW)</p>	<p>PLAYING</p>	<p>MARCHING WHILE NOT PLAYING</p>

Figure 14-2- 12 Drill Positions for Snare Drum and Tenor Drum (Side Slung) (A)



Figure 14-2-12

Drill Positions for Snare Drum and Tenor Drum (Side Slung) (B)



Figure 14-2- 13 Drill Positions for Snare Drum (Flat Mount) (A)



Figure 14-2-13

Drill Positions for Snare Drum (Flat Mount) (B)



Figure 14-2- 14

Drill Positions for Bass Drum (A)



Figure 14-2-14 Drill Positions for Bass Drum (B)



Figure 14-2- 15

Drill Positions for Cymbals

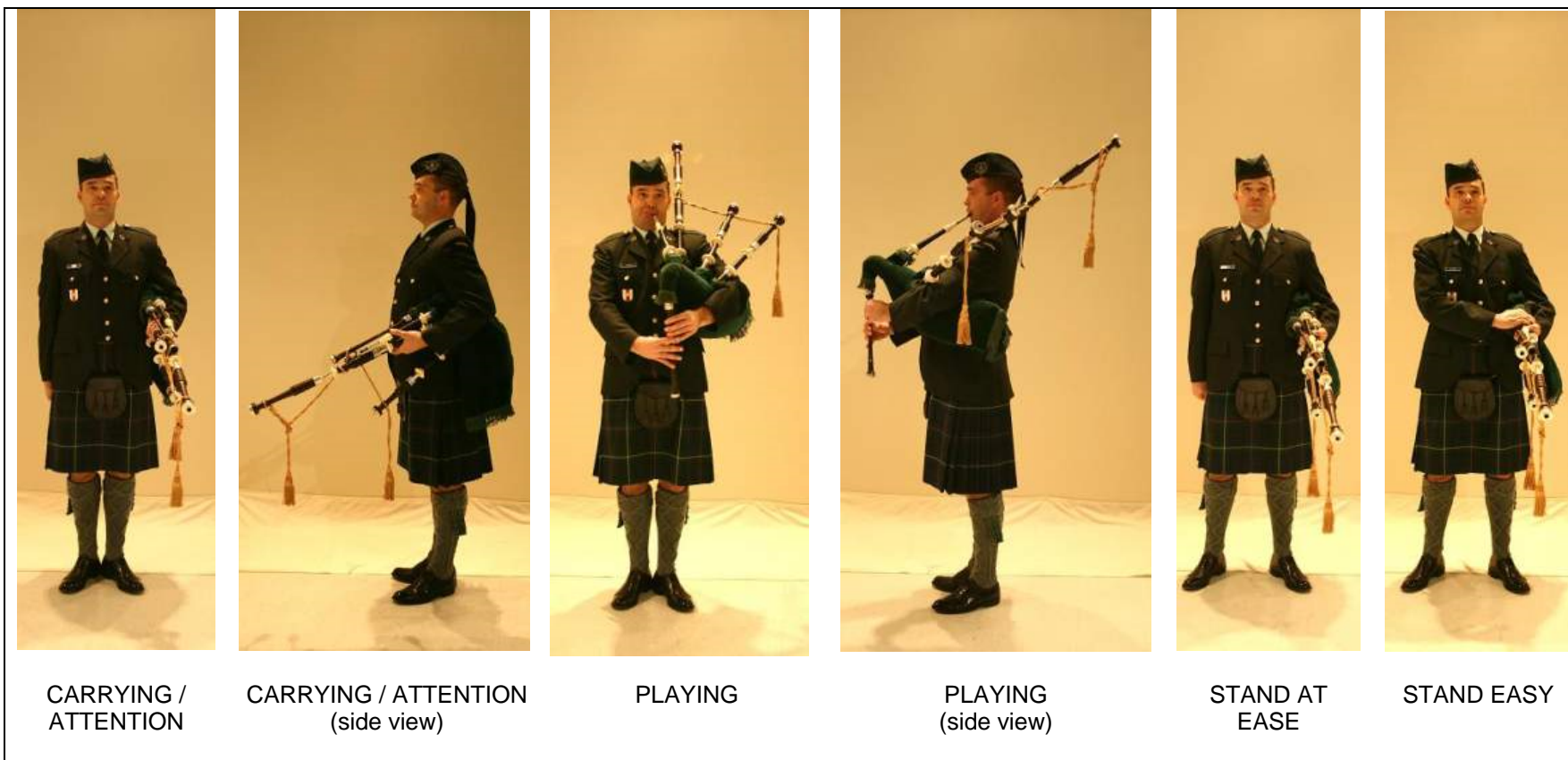

Figure 14-2- 16 **Drill Positions for Bagpipes (A)**

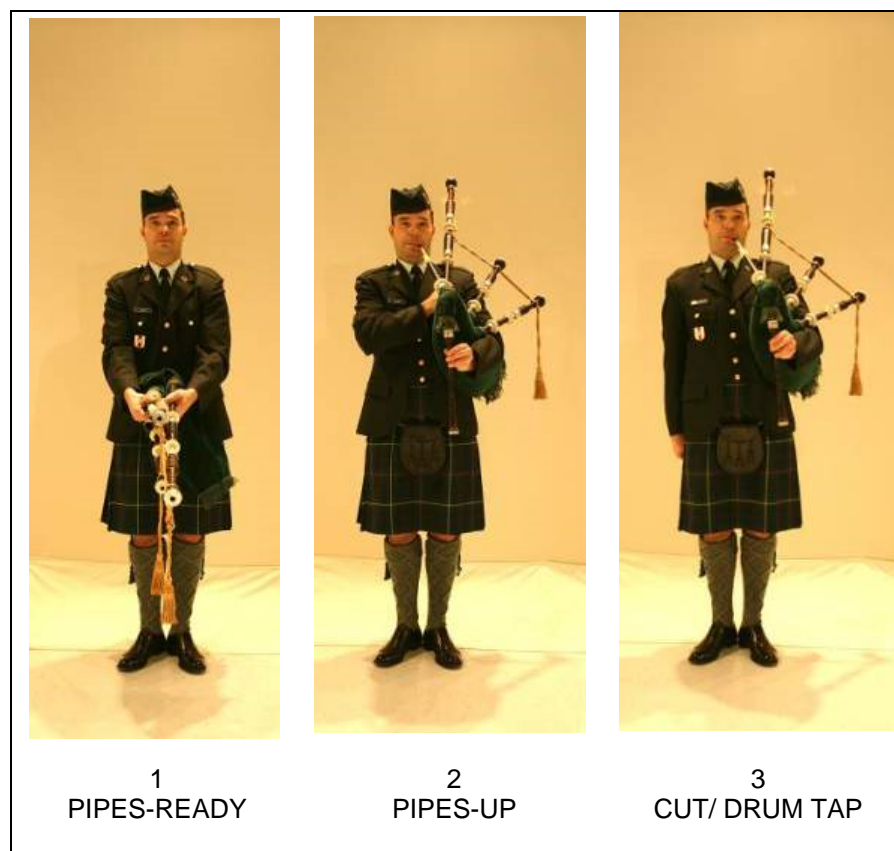

Figure 14-2-16 Drill Positions for Bagpipes – PREPARE TO PLAY (B)

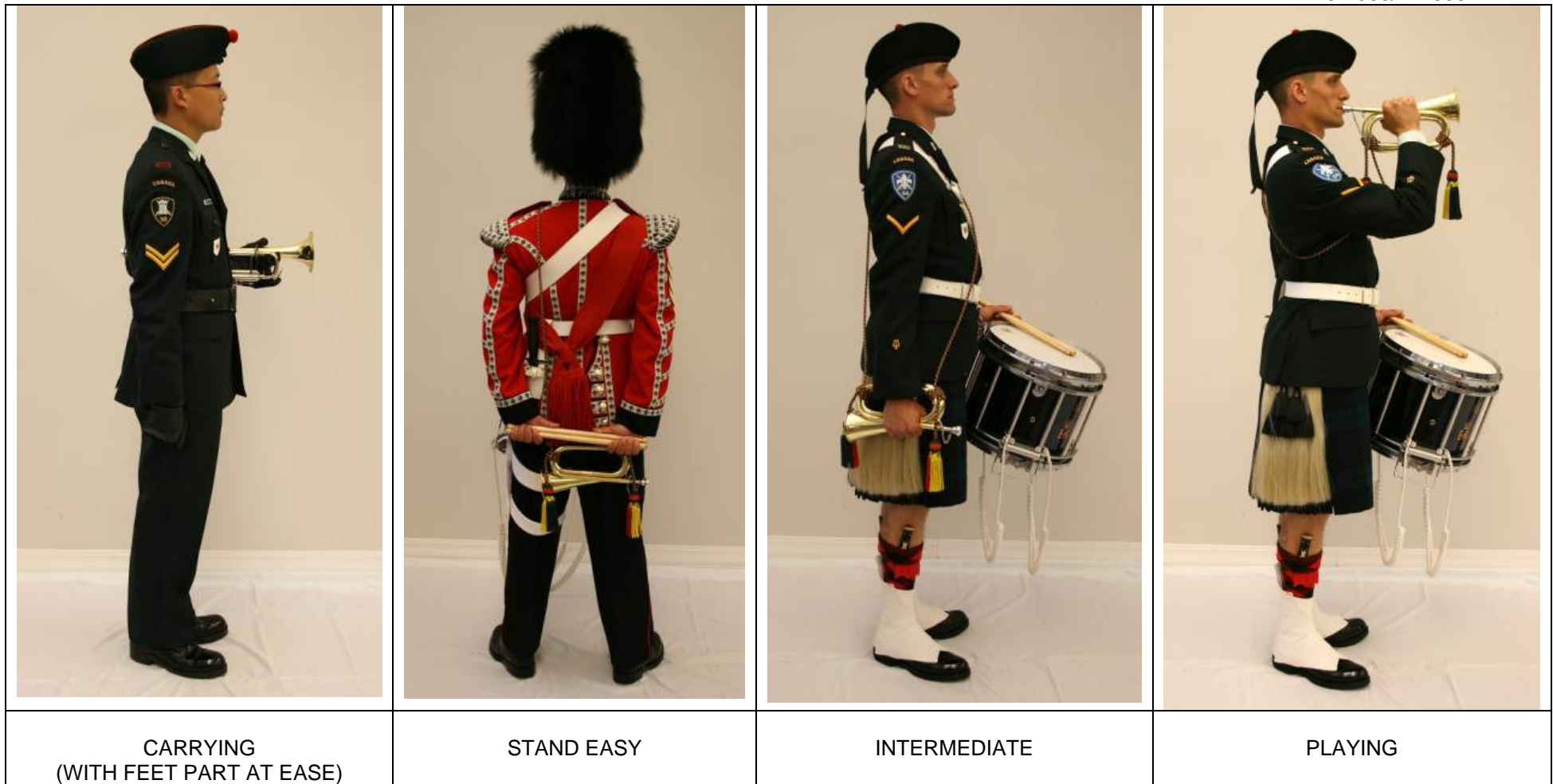

Figure 14-2- 17 Drill Positions for Piston Bugle and Bugle (A)

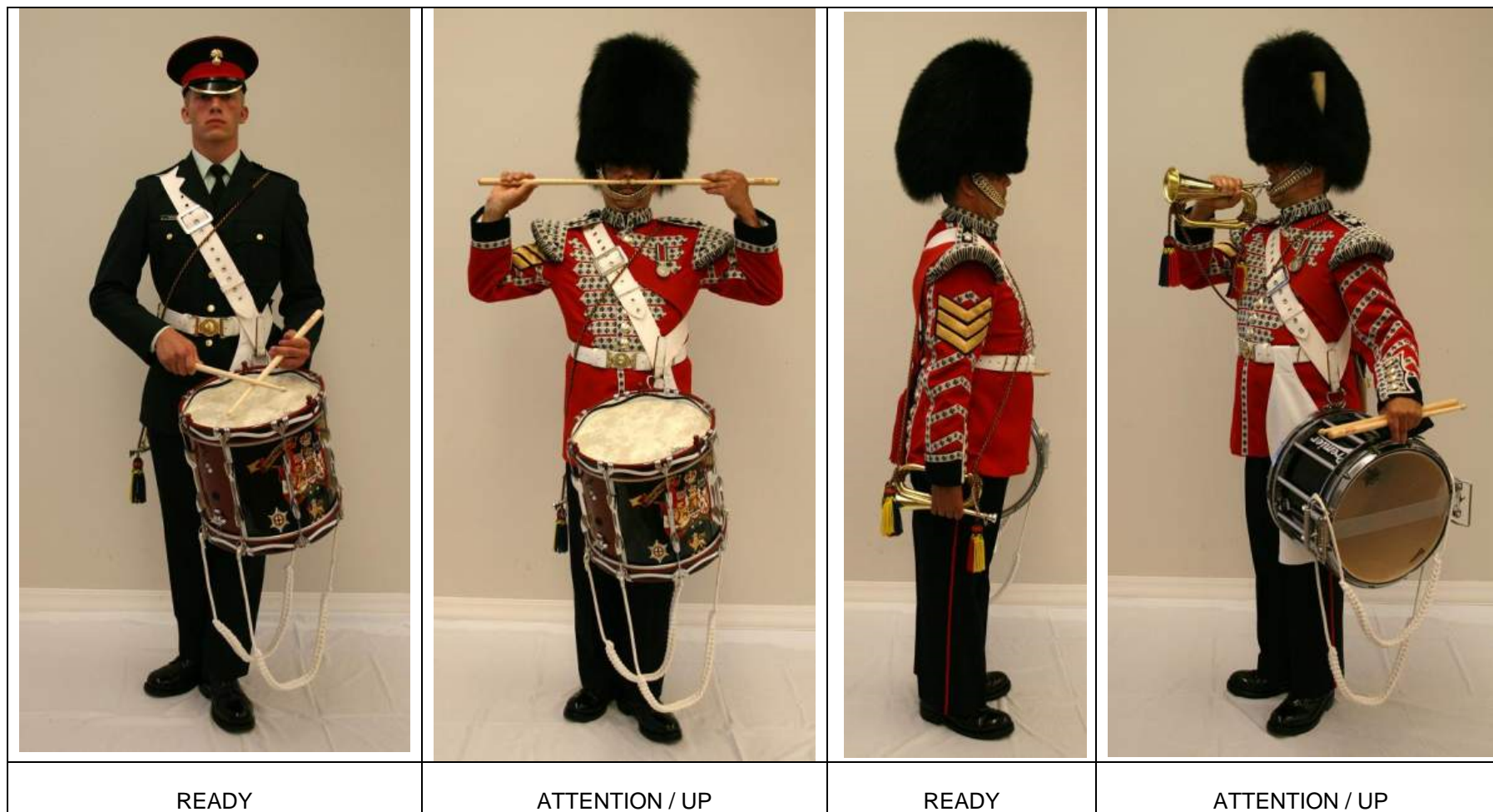

Figure 14-2-17 Drill Positions for Drum and Bugle Duty - Prepare to Play (B)



Figure 14-2- 18 Drill Positions for Fanfare Trumpet

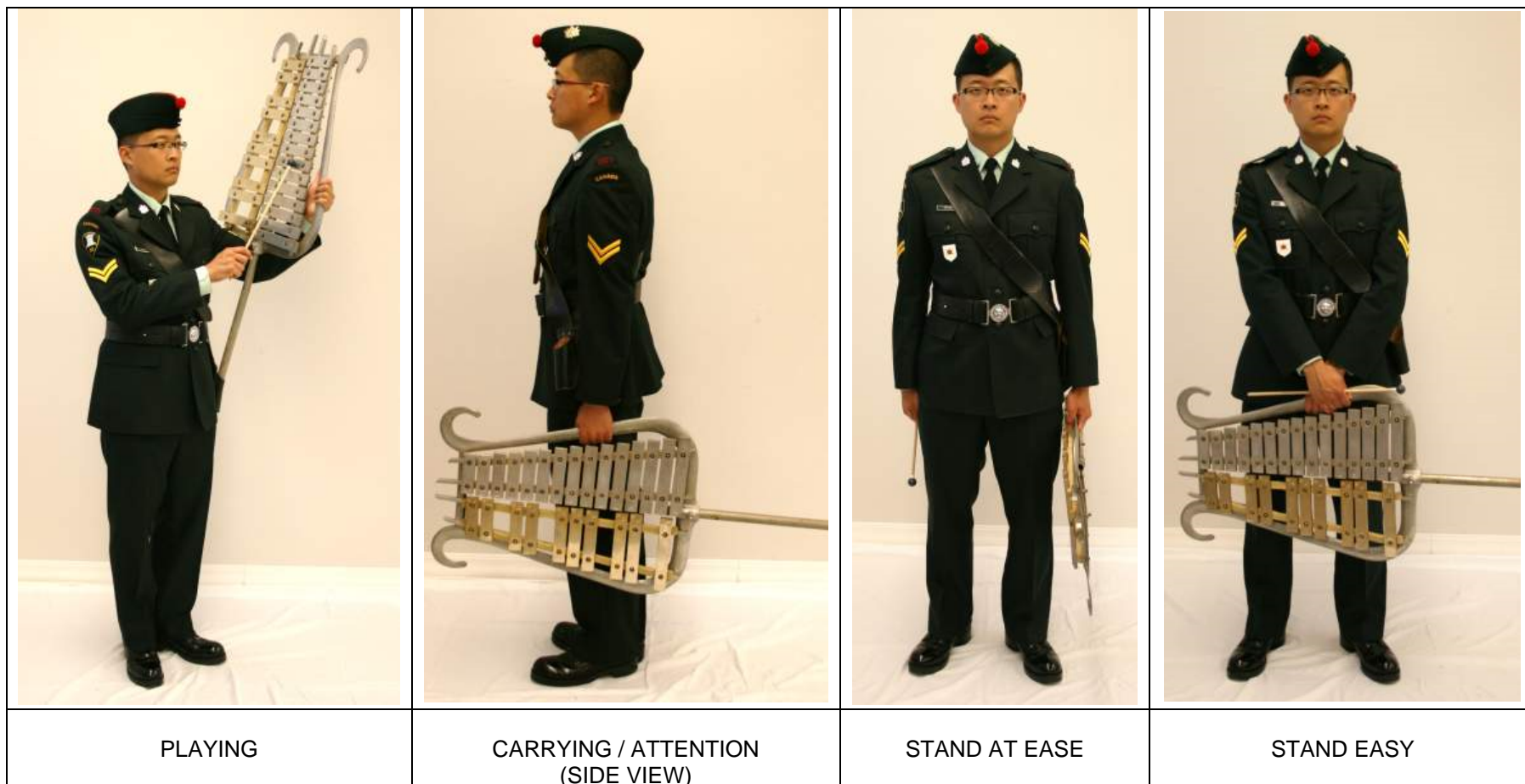

Figure 14-2- 19 Drill Positions for Bell Lyre

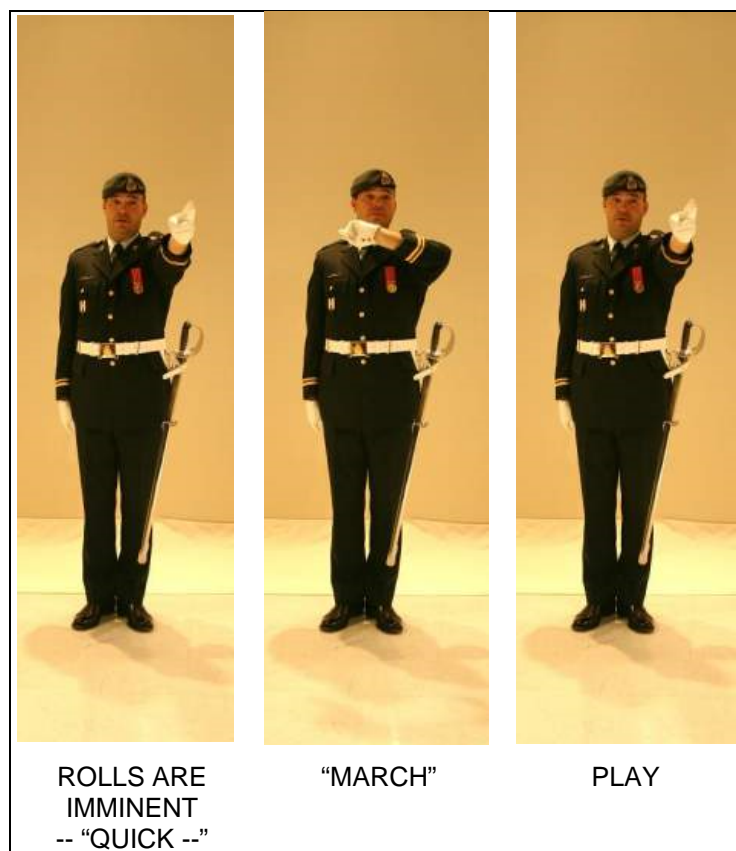

Figure 14-3- 1/A

Conductor – Starting a March at the Halt



Figure 14-3-1/B

Conductor – Starting Without Drum Rolls

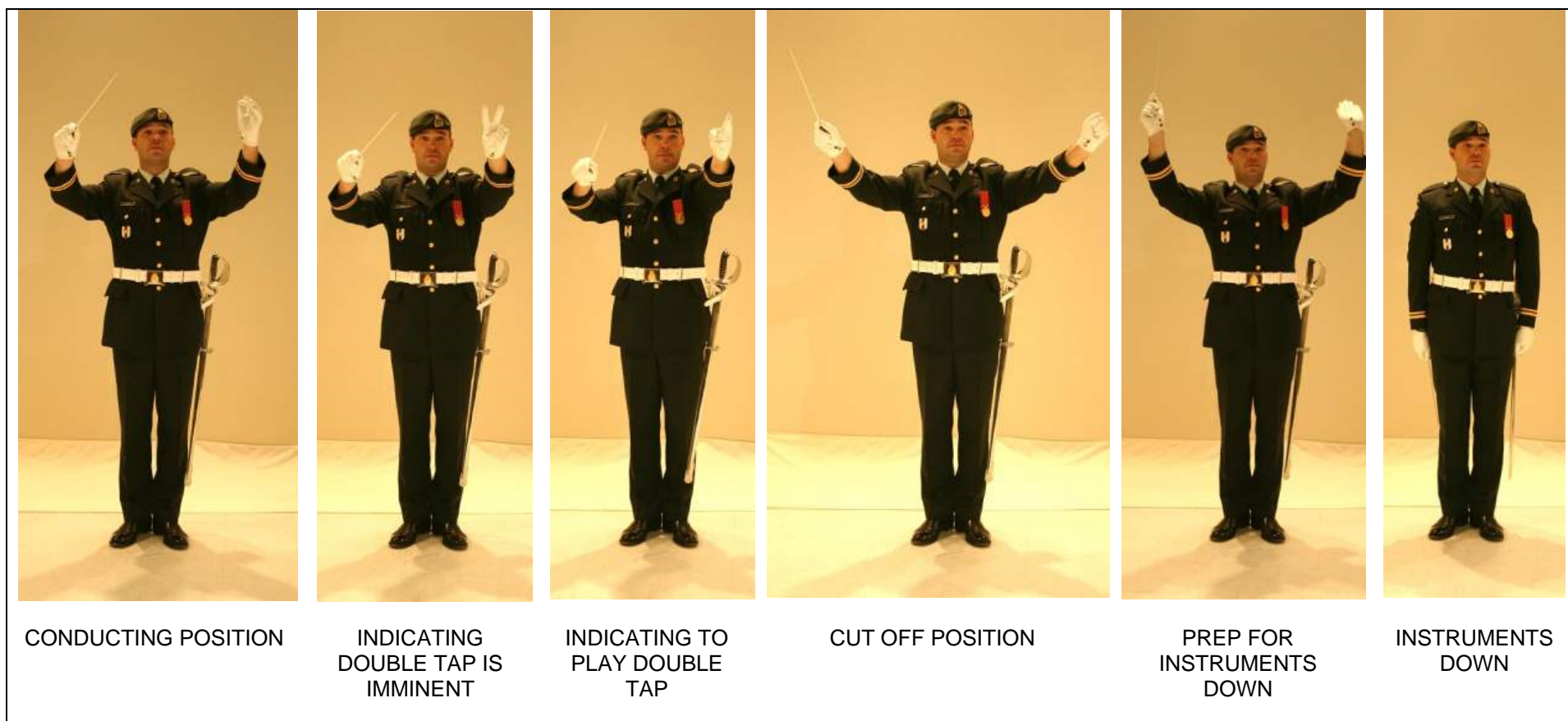
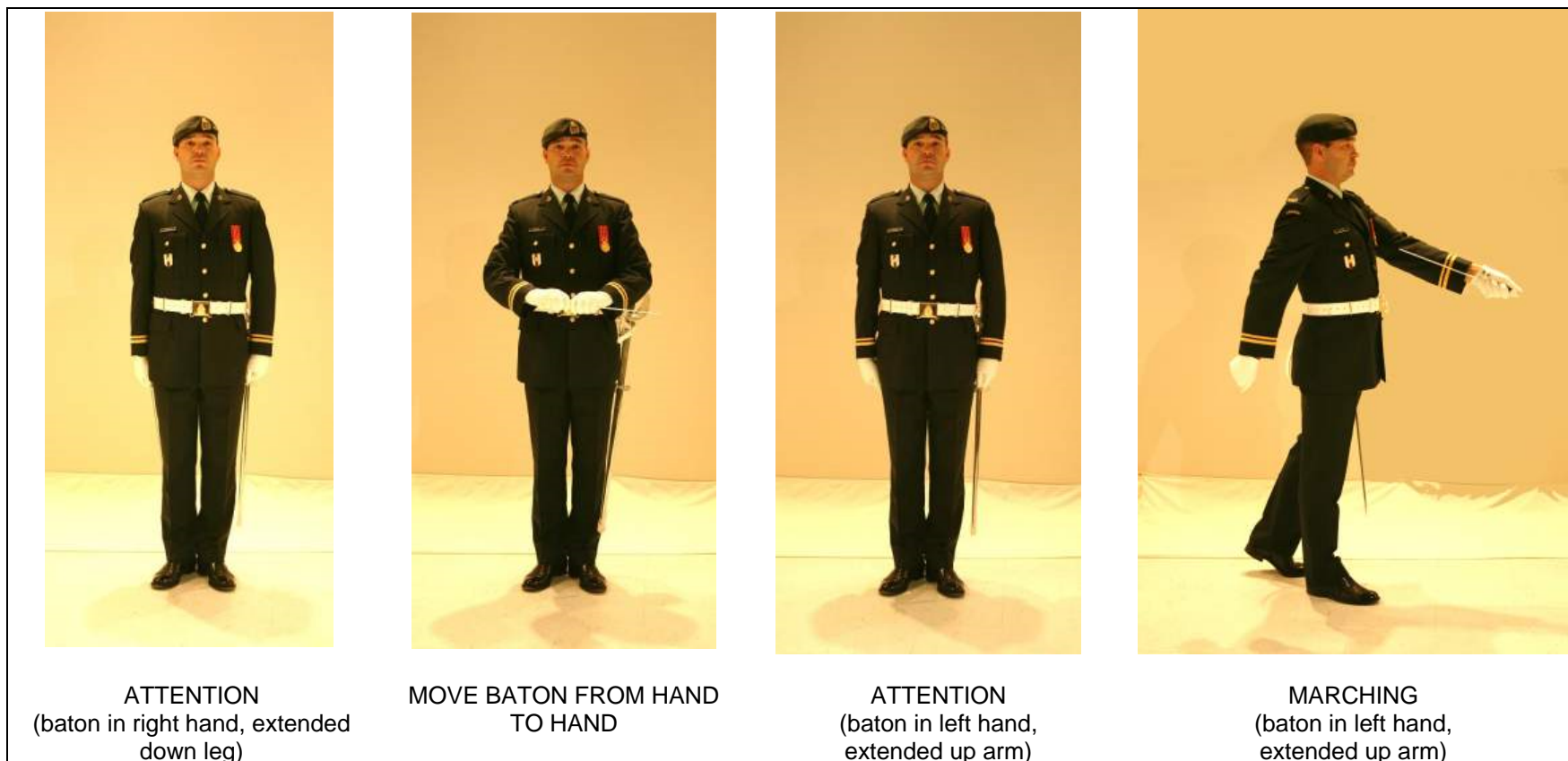

Figure 14-3- 2 Conductor – Conducting and Ending a March



ATTENTION
(baton in right hand, extended
down leg)

MOVE BATON FROM HAND
TO HAND

ATTENTION
(baton in left hand,
extended up arm)

MARCHING
(baton in left hand,
extended up arm)

Figure 14-3- 3 Conductor – Baton Carriage

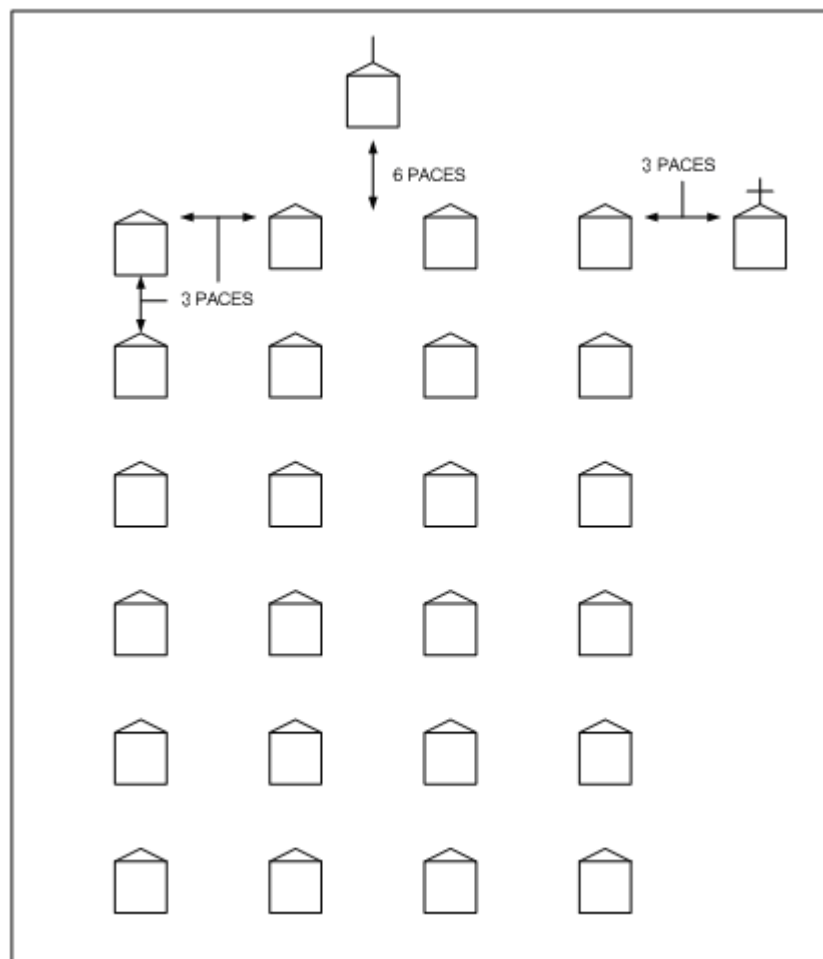

Figure 14-4- 1 **Basic Band Formation, Even Number of Files**

NOTE

Conductors and drum majors may adopt other positions according to circumstances and the nature of the duty.

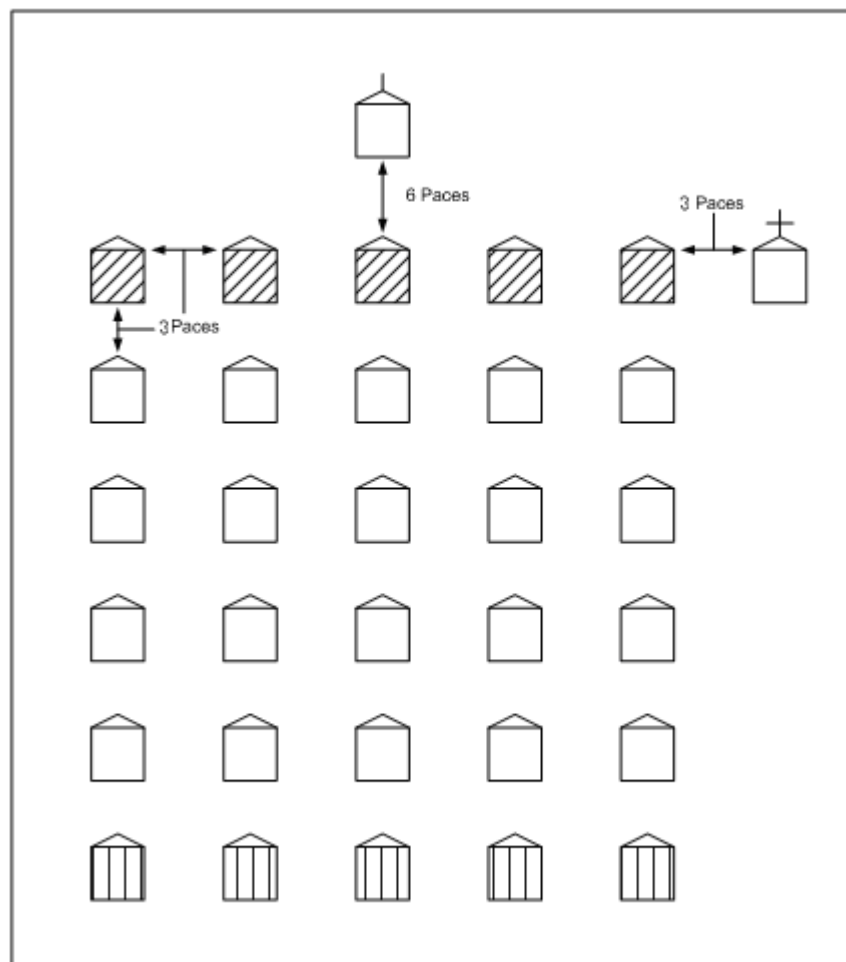

Figure 14-4- 2 Basic Band Formation, Odd Number of Files

NOTE

Conductors and drum majors may adopt other positions according to circumstances and the nature of the duty.

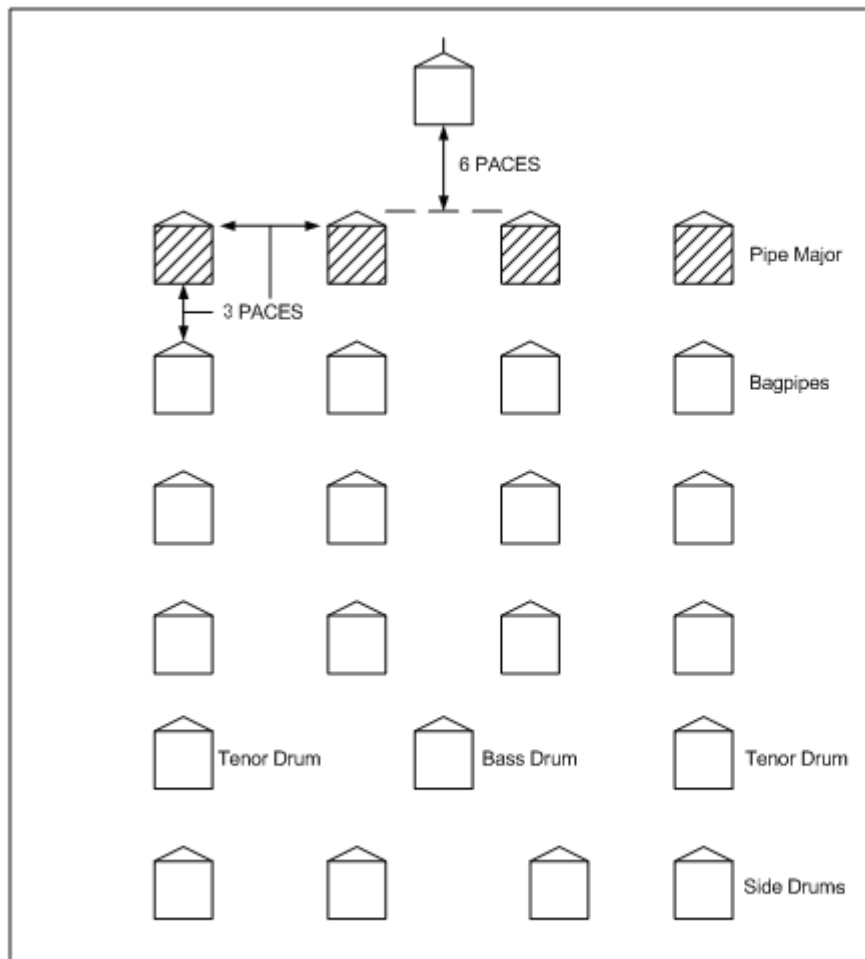

Figure 14-4- 3 Band Formation, Pipes and Drums

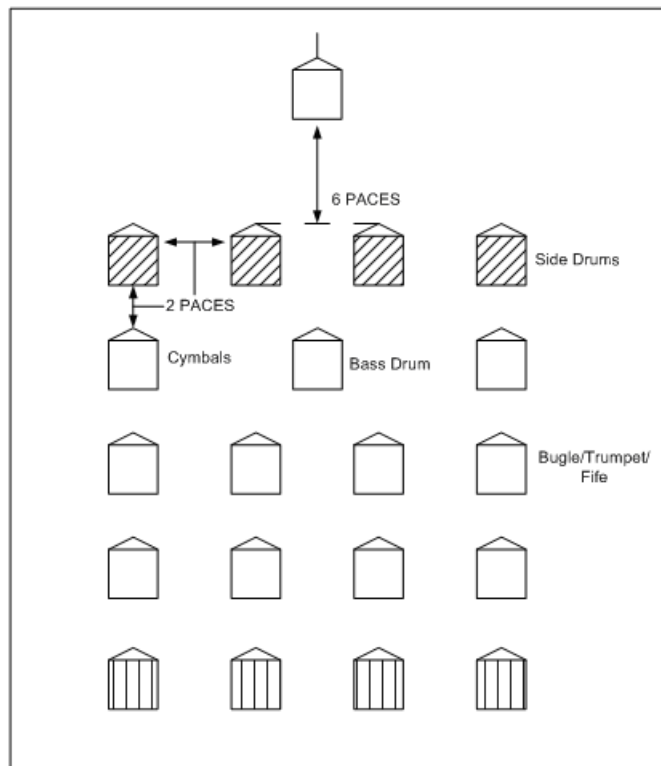

Figure 14-4- 4 Band Formation, Corps of Drums/Fifes/Trumpets/Bugles

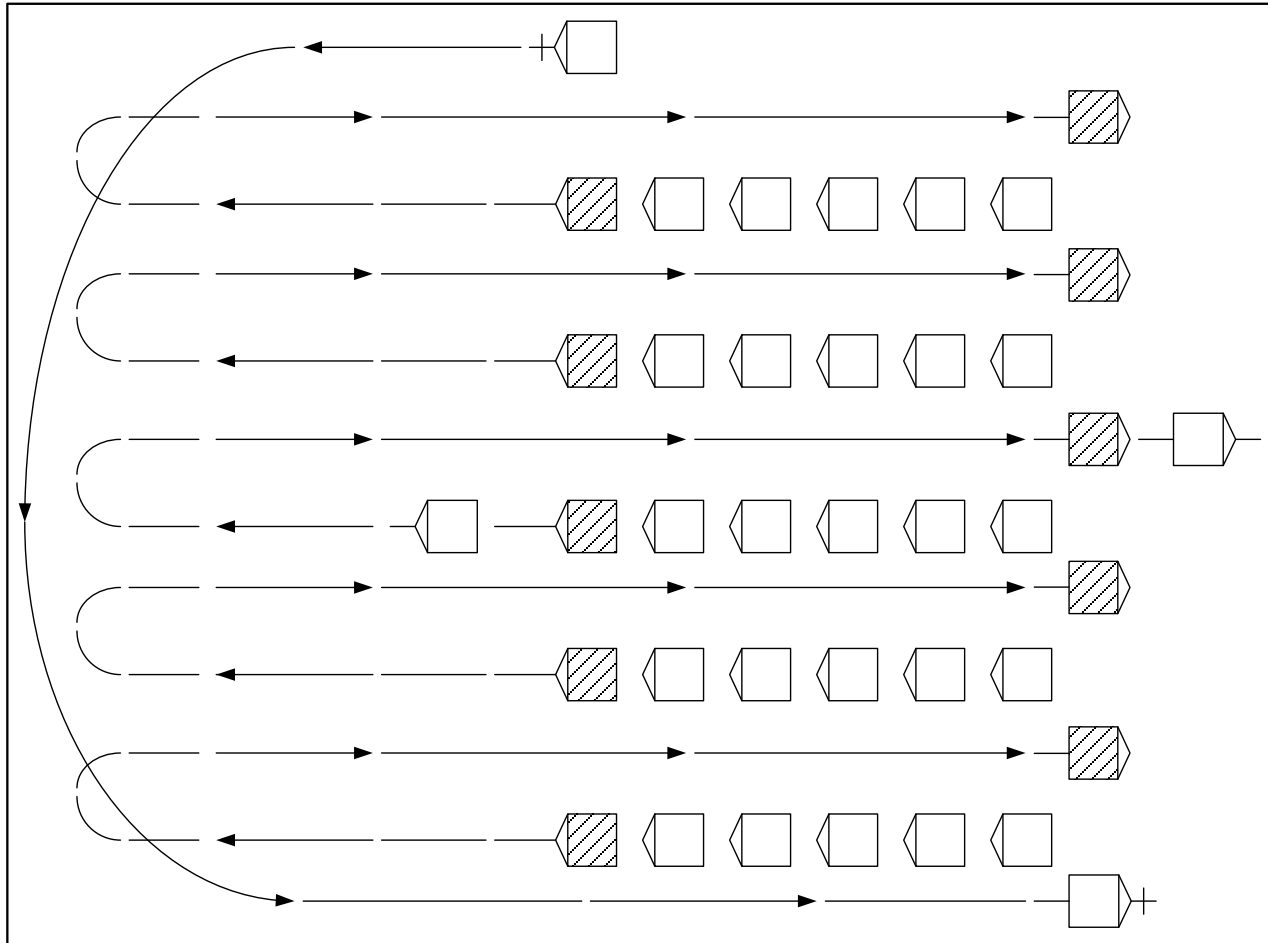

Figure 14-4- 5

Standard Countermarch

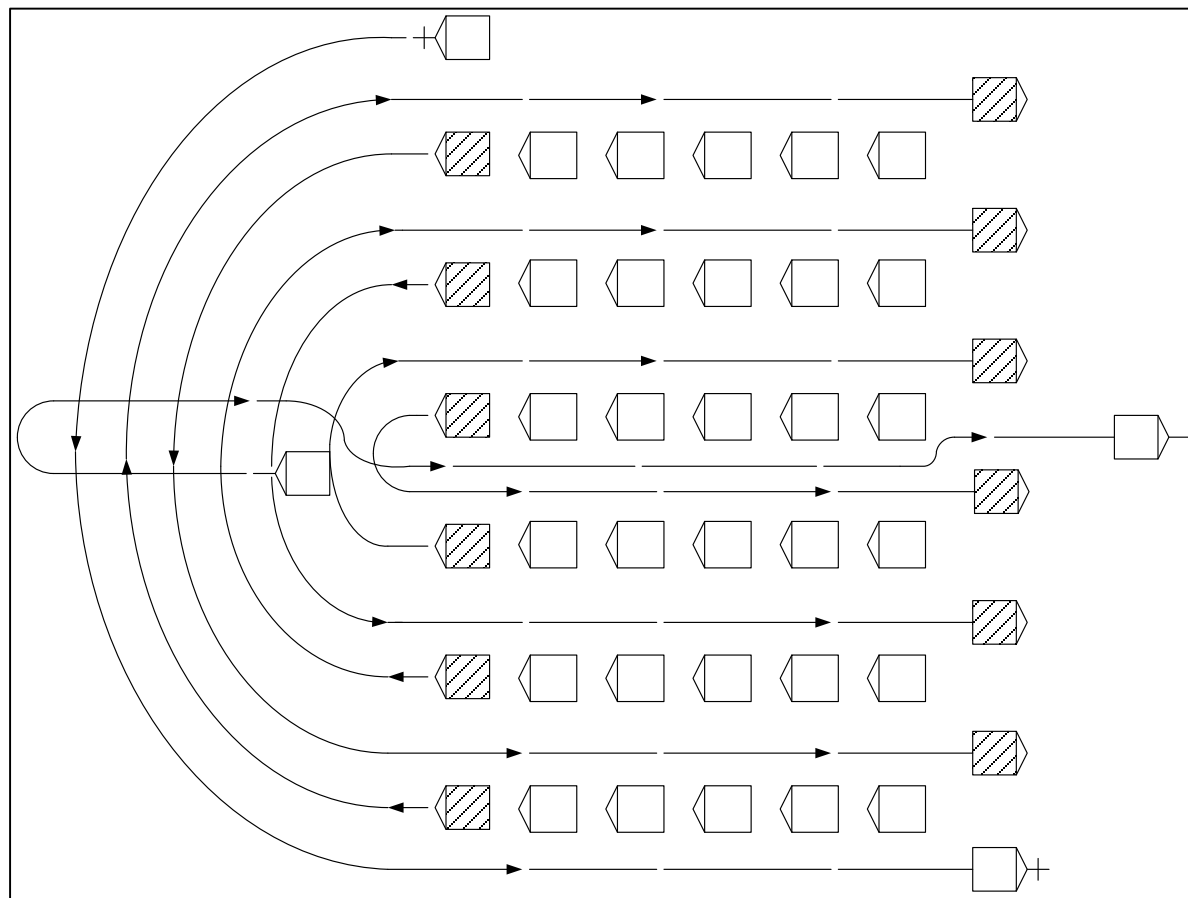

Figure 14-4- 6

Spiral Countermarch – Band With Even Number of Files

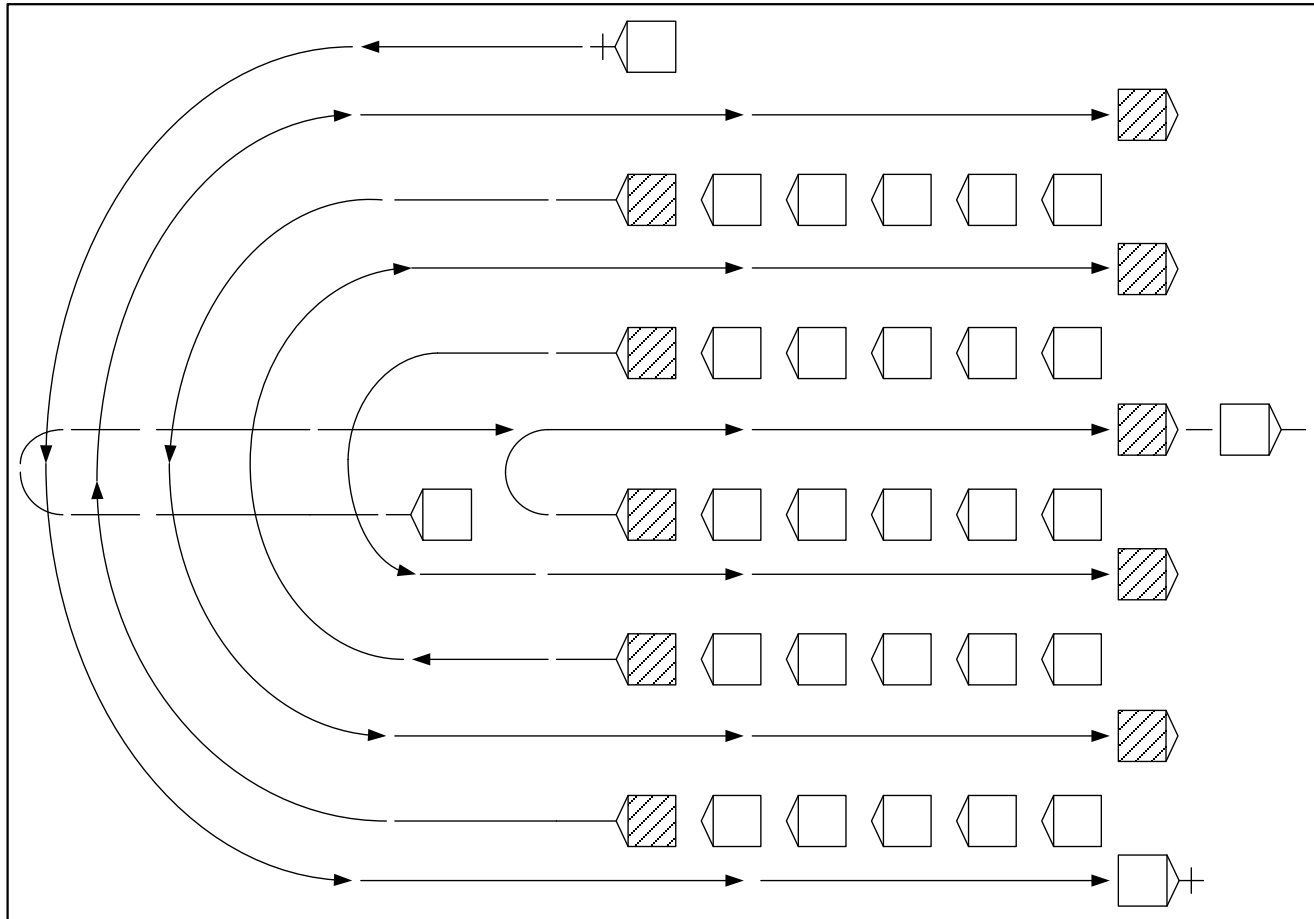

Figure 14-4- 7 Spiral Counter-march – Band With Odd Number of Files

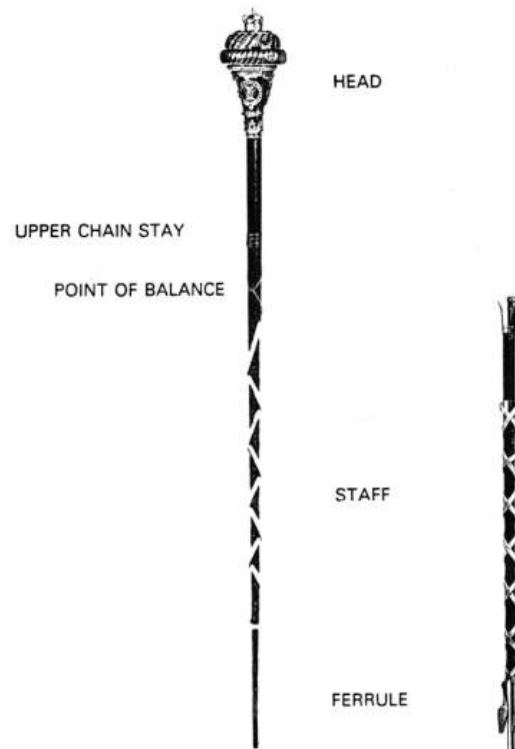

Figure 14-5- 1 Drum Major's Mace and Parade Cane

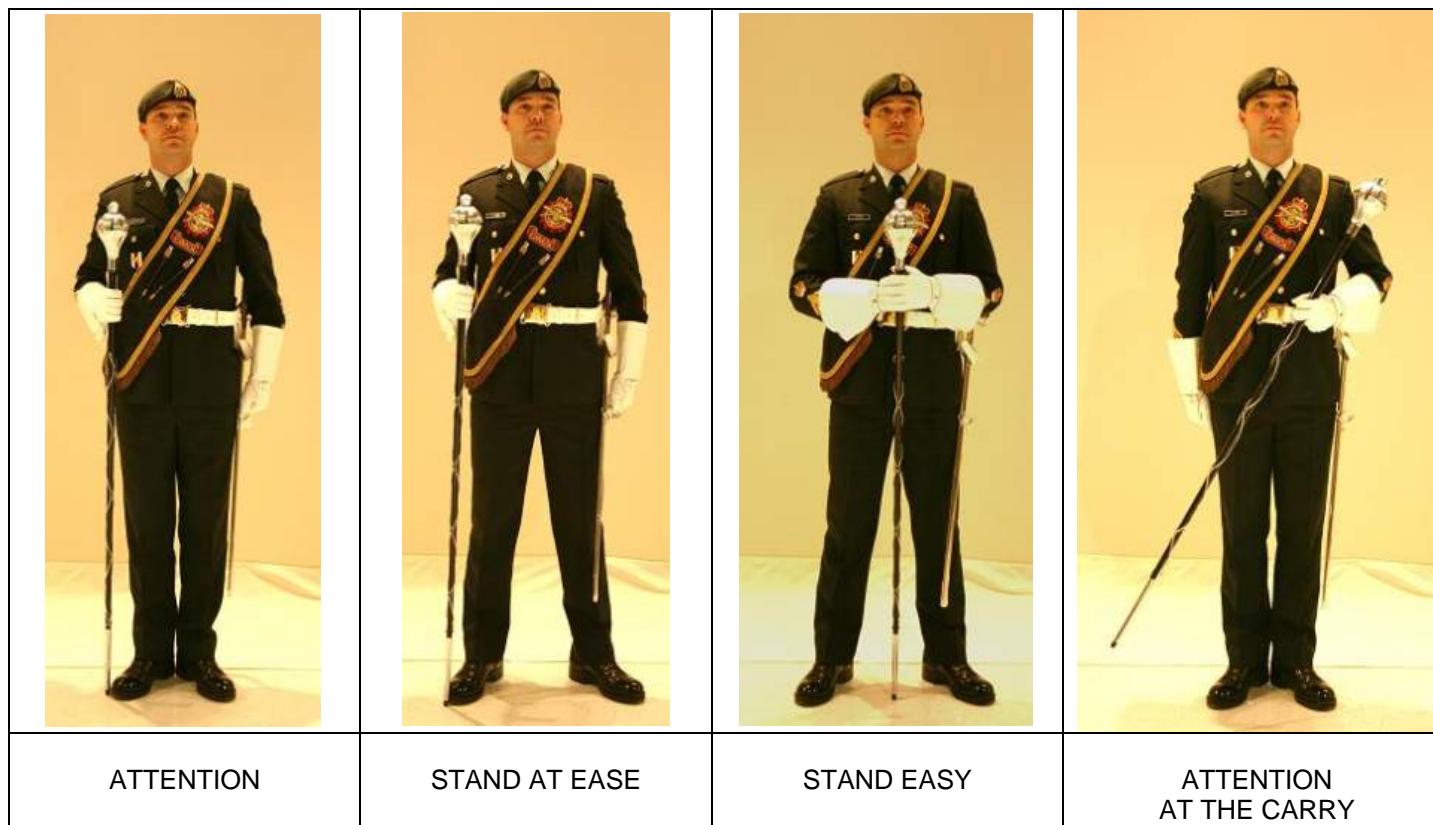

Figure 14-5- 2 Drum Major – Basic Positions

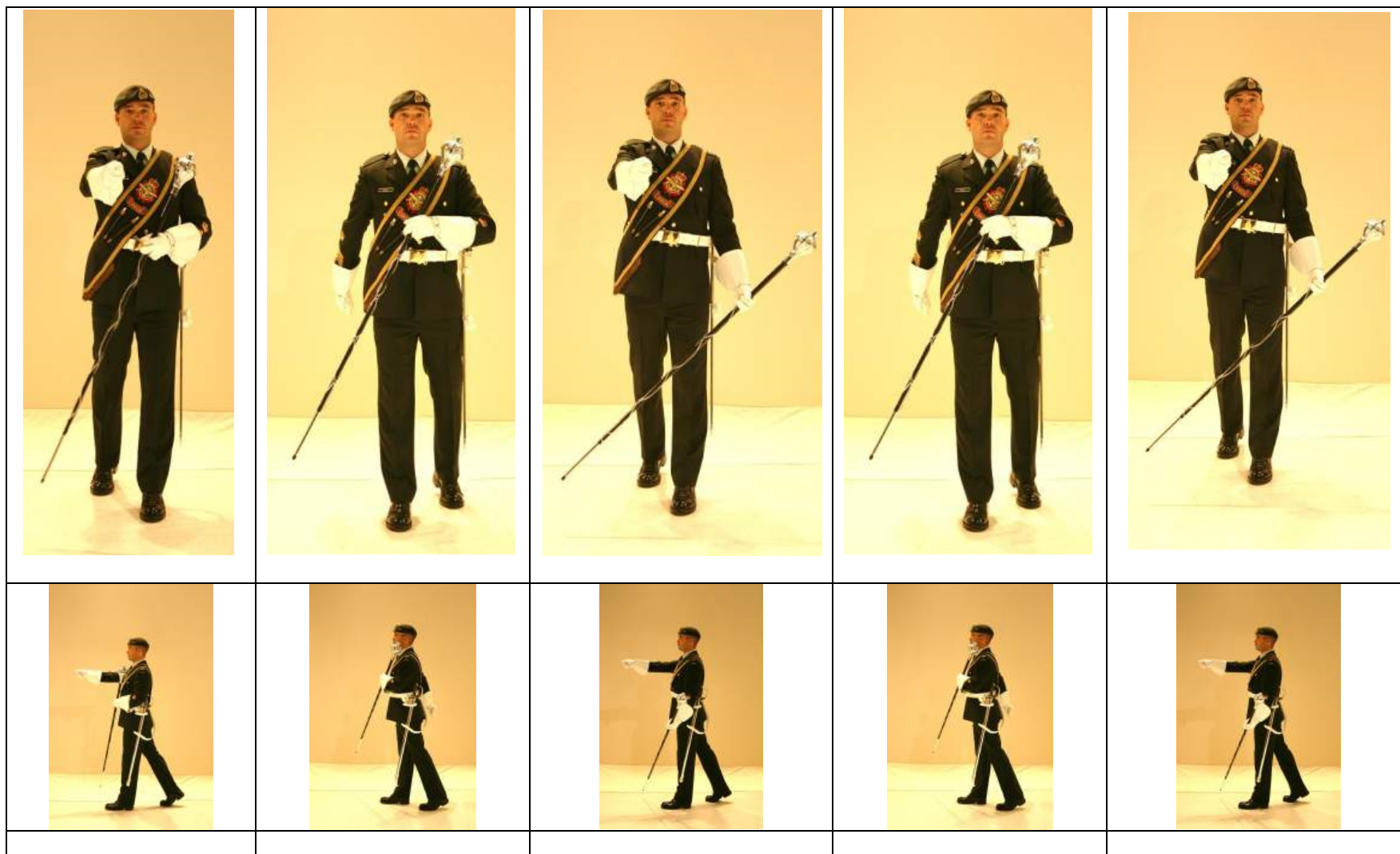

Figure 14-5- 3

Drum Major – Carry Position While Marching, and Rolling the Mace

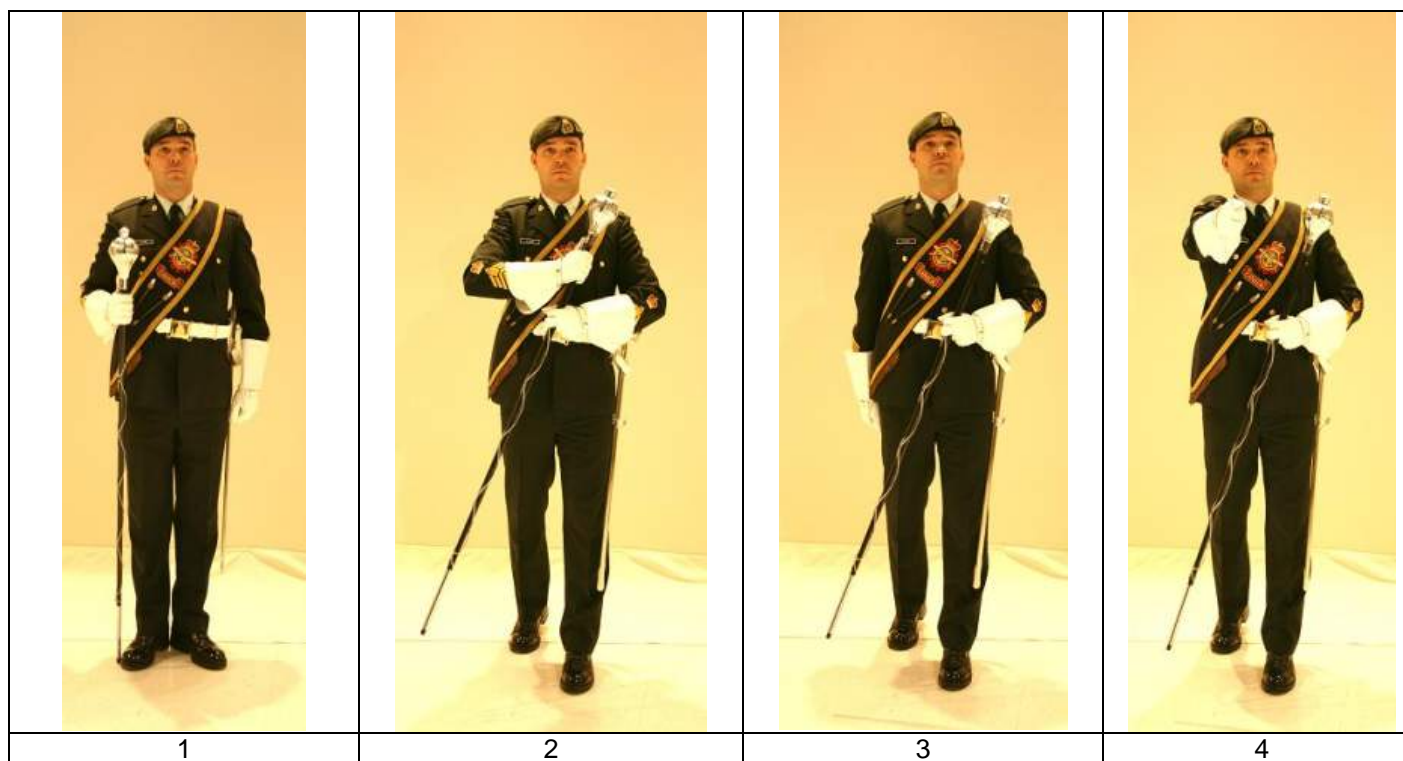

Figure 14-5- 4 Drum Major – Stepping Off Into the Carry in Quick Time



Figure 14-5- 5 Drum Major – Stepping Off Into the Carry in Slow Time



Figure 14-5- 6 Drum Major - Saluting

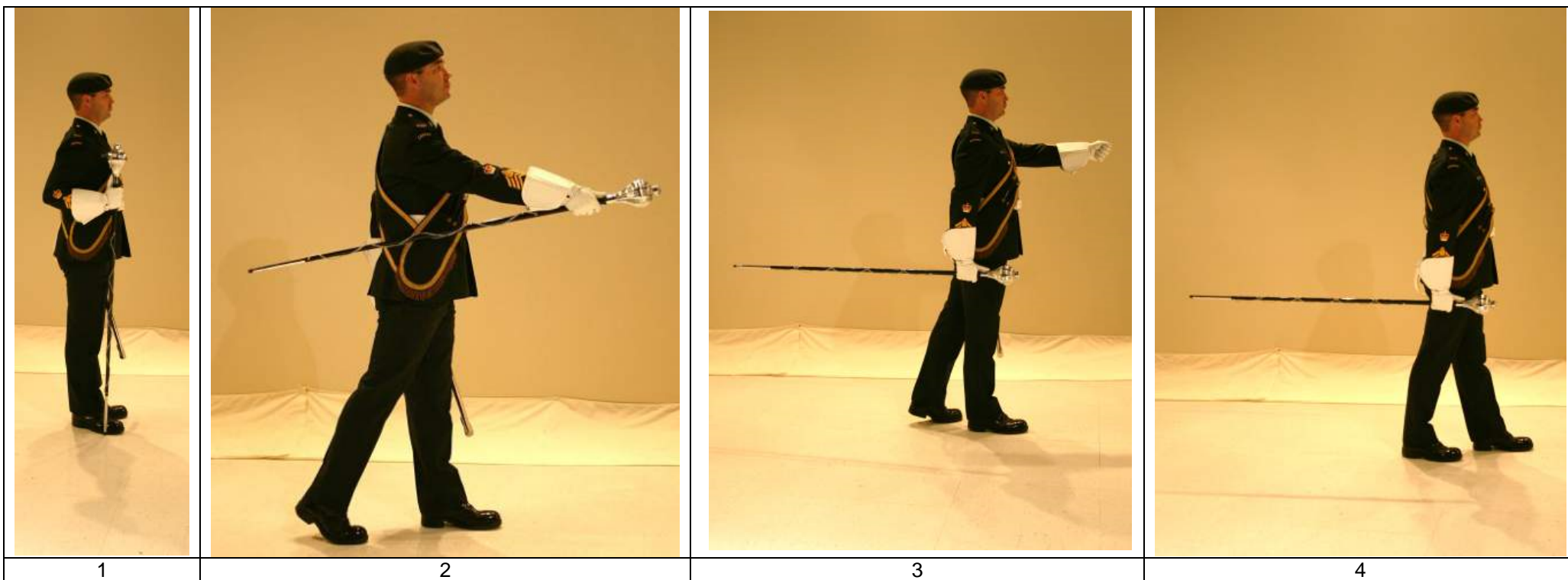

Figure 14-5- 7 Drum Major – Stepping Off into the Trail

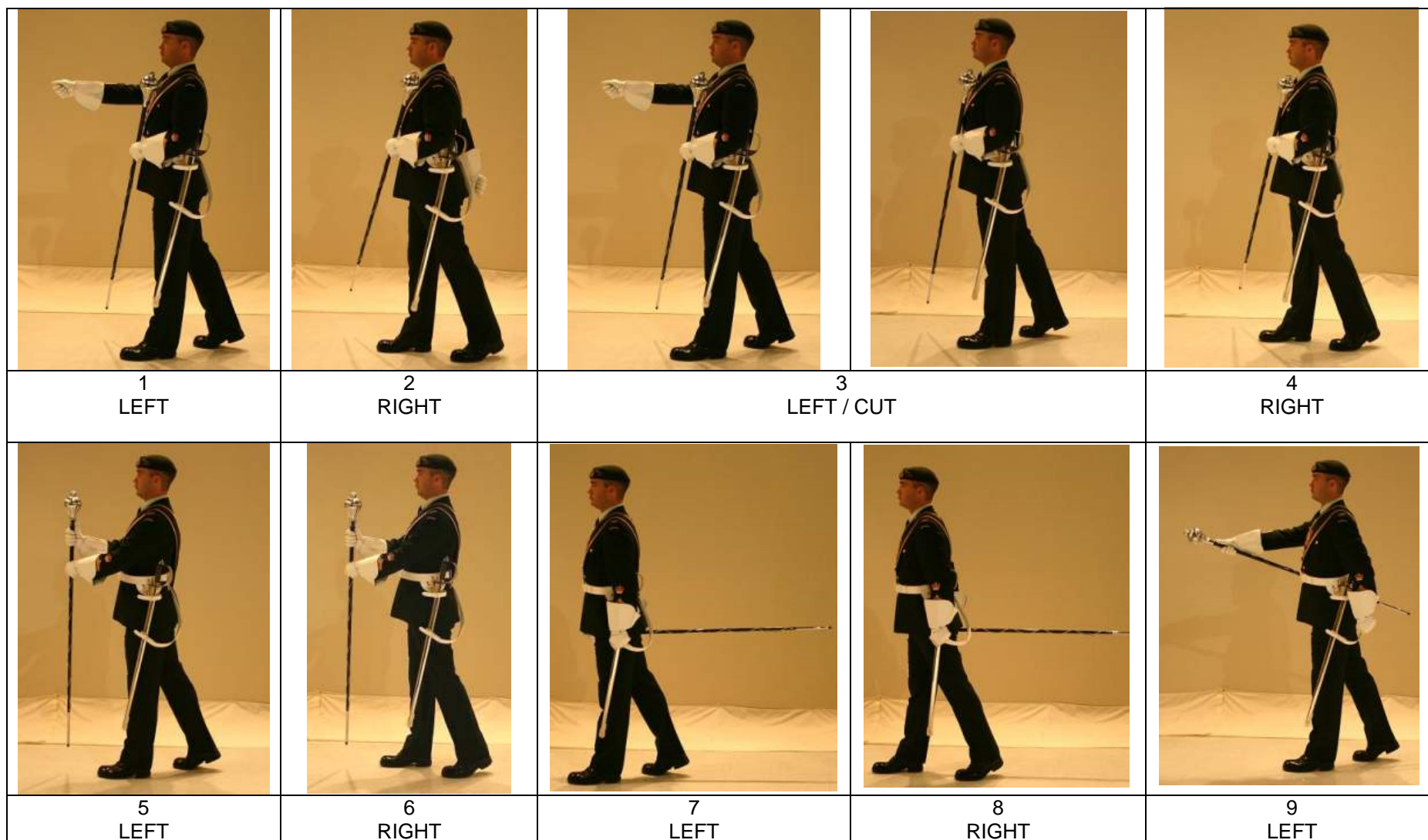

Figure 14-5- 8

Drum Major – Changing from the Carry to the Trail in Quick Time: Viewed from the Left

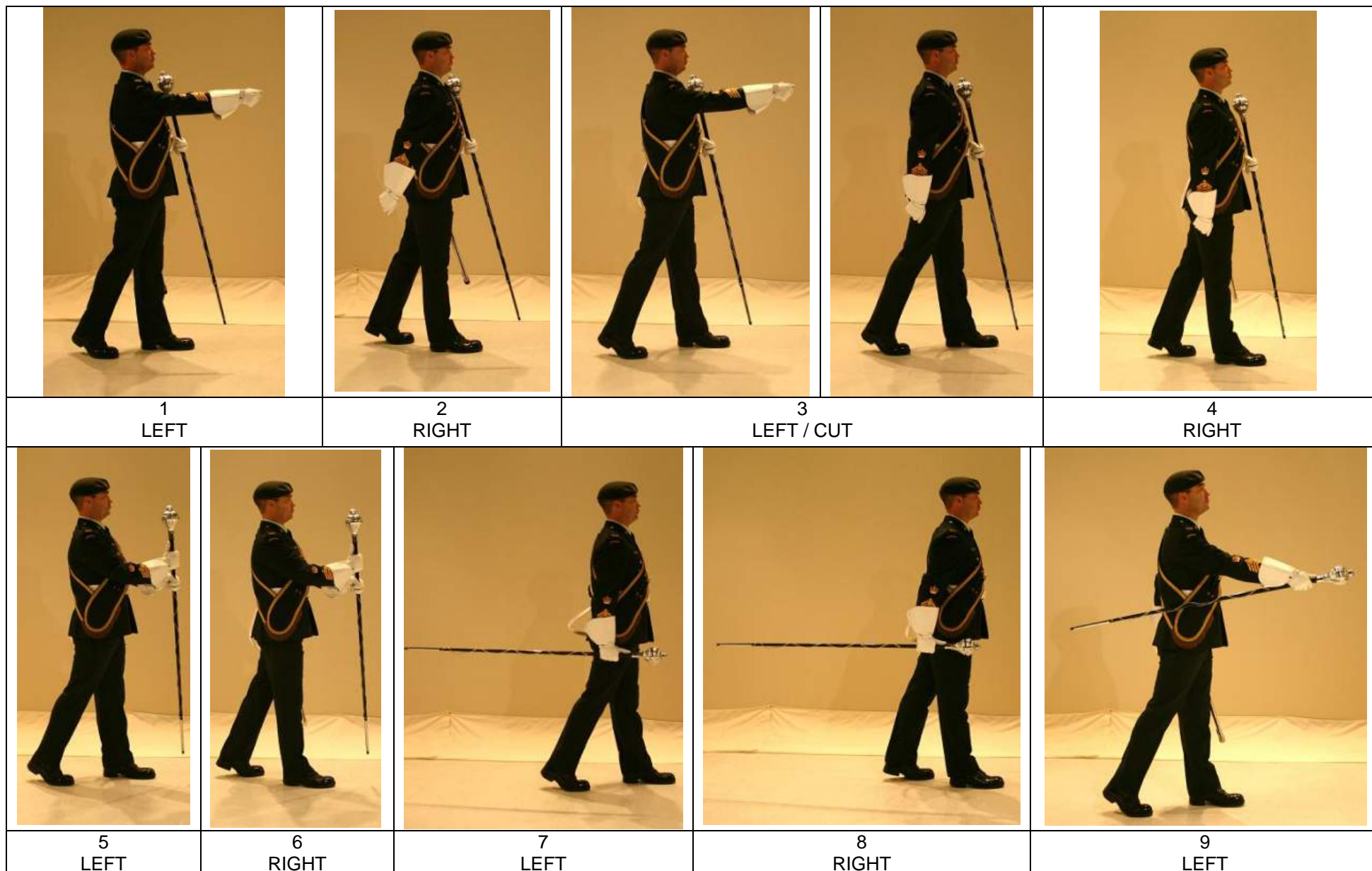

Figure 14-5- 9

Drum Major – Changing from Carry to the Trail in Quick Time: Viewed from the Right

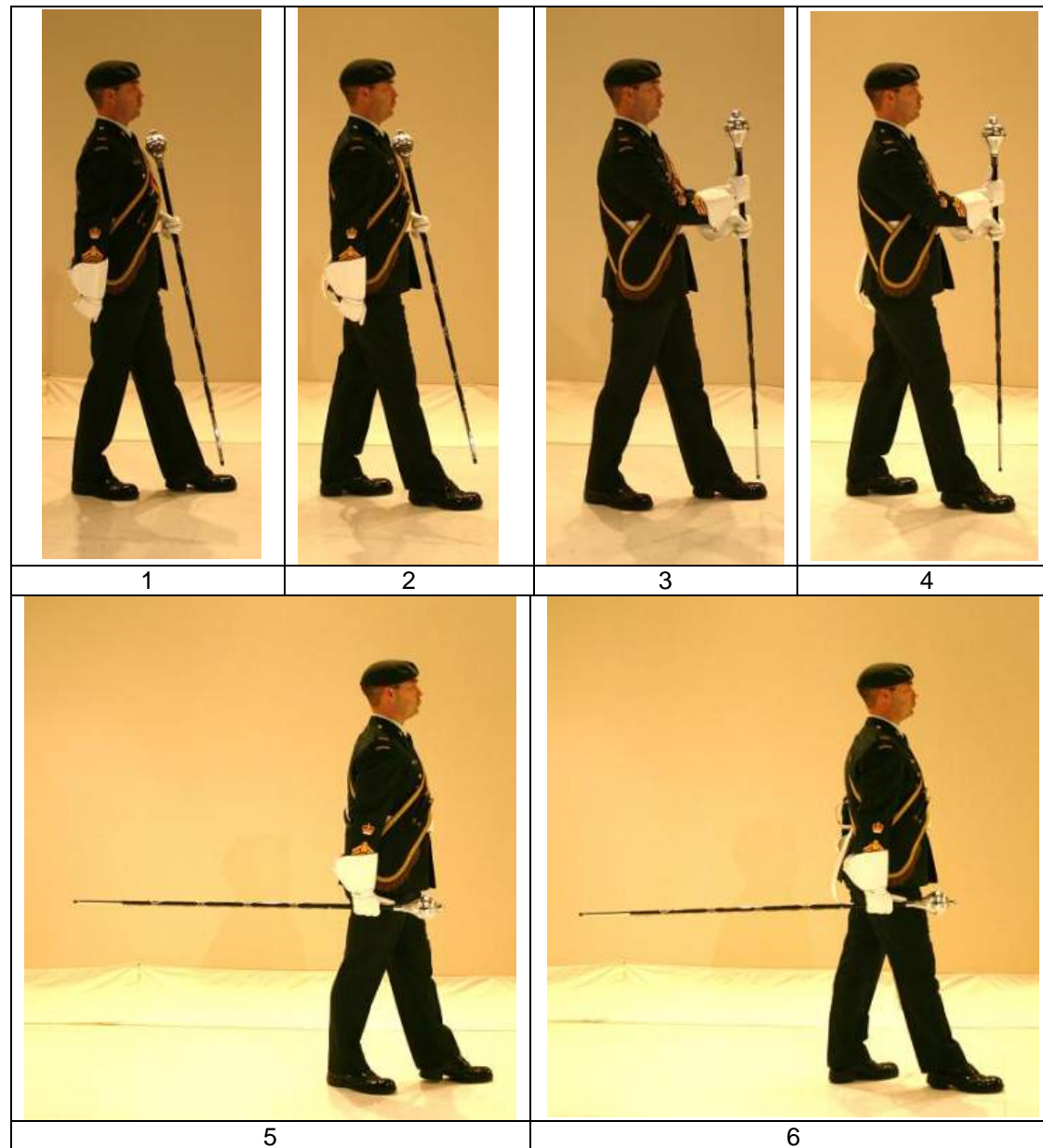

Figure 14-5- 10

Changing from the Carry to the Trail in Slow Time

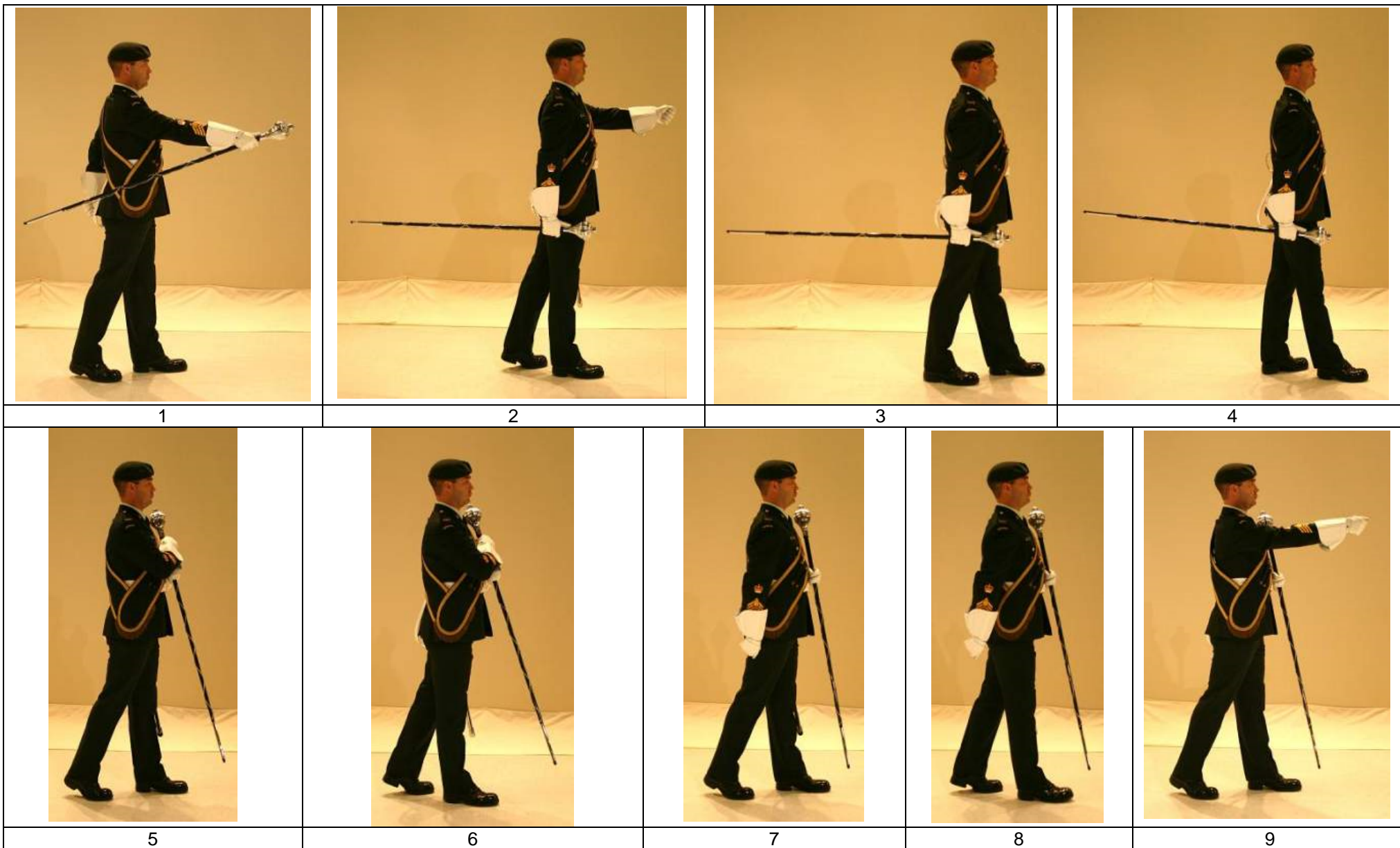

Figure 14-5- 11

Drum Major – Changing from the Trail to the Carry in Quick Time

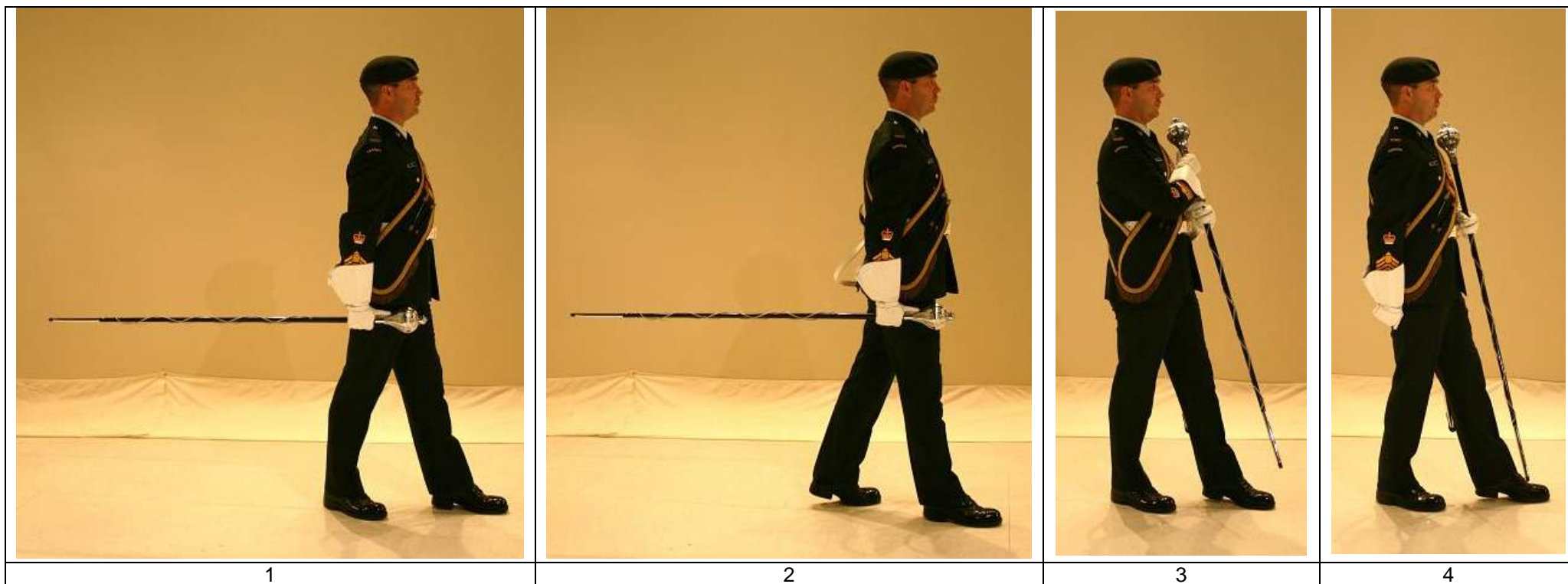

Figure 14-5- 12

Drum Major – Changing from the Trail to the Carry in Slow Time

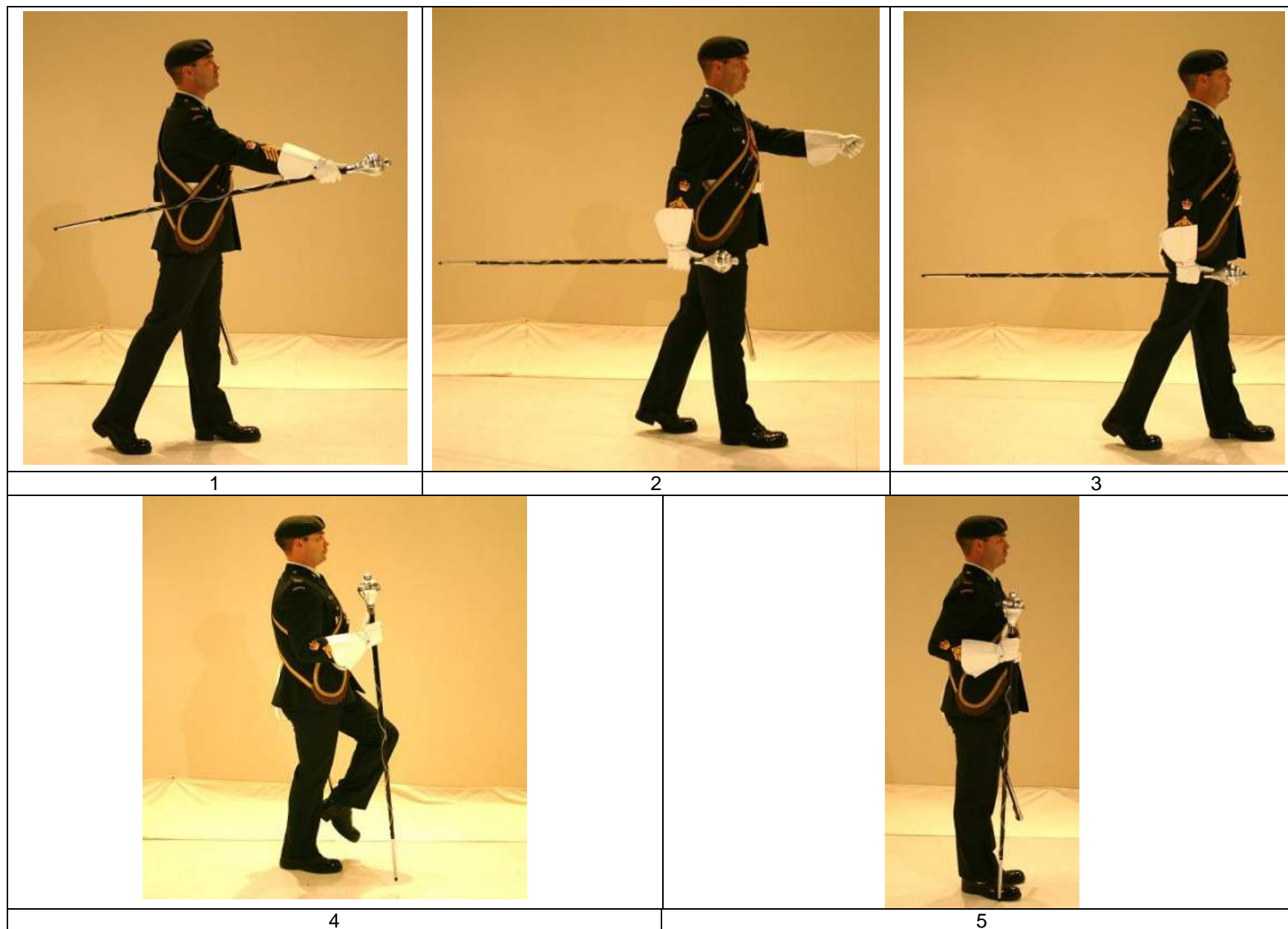

Figure 14-5- 13 Drum Major – Halting When Marching At the Trail

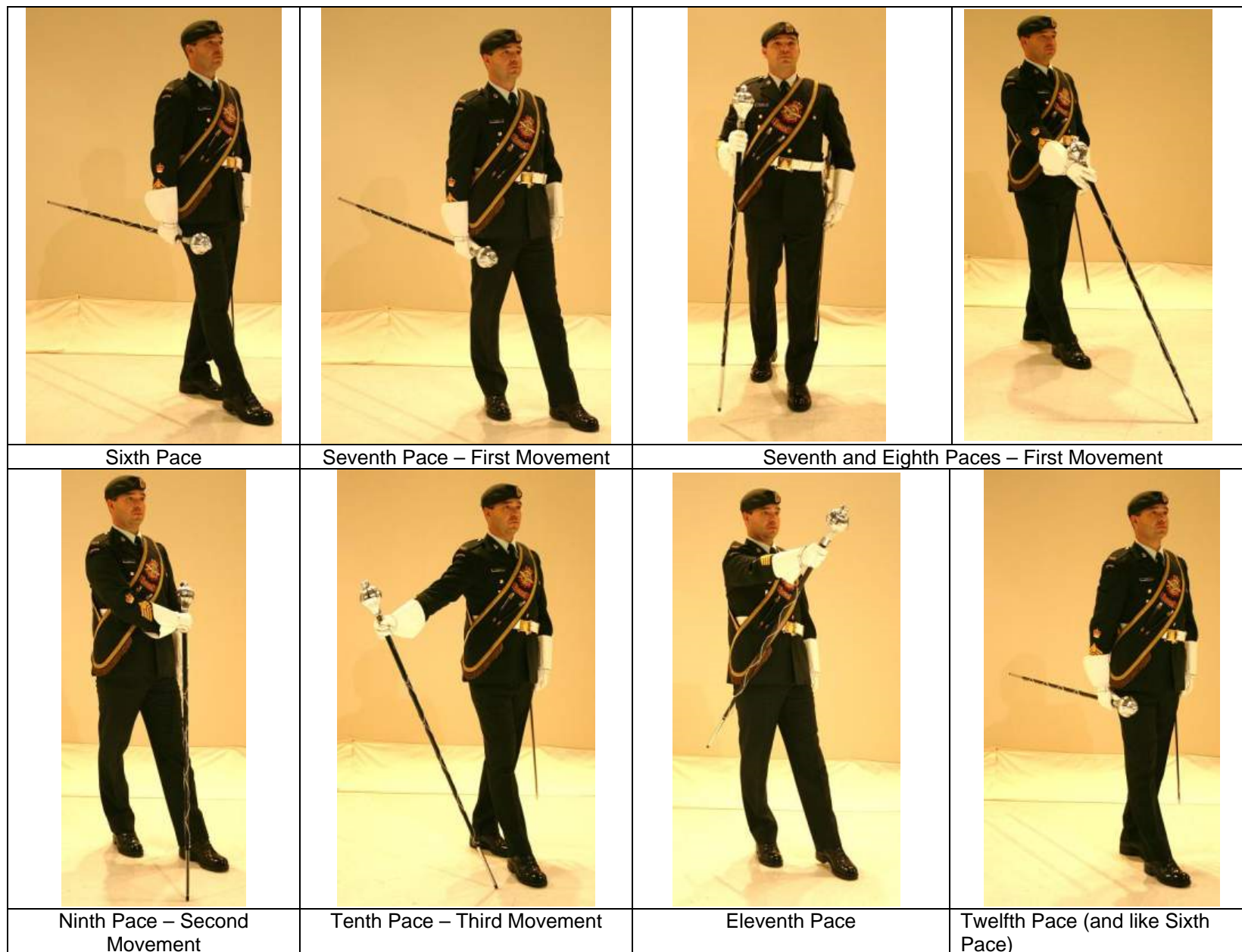

Figure 14-5- 14 Drum Major – The State Walk in Slow Time



Figure 14-5- 15 Drum Major – Walking the Mace in Quick Time



Figure 14-5- 16 Drum Major – Stepping Off From the Halt

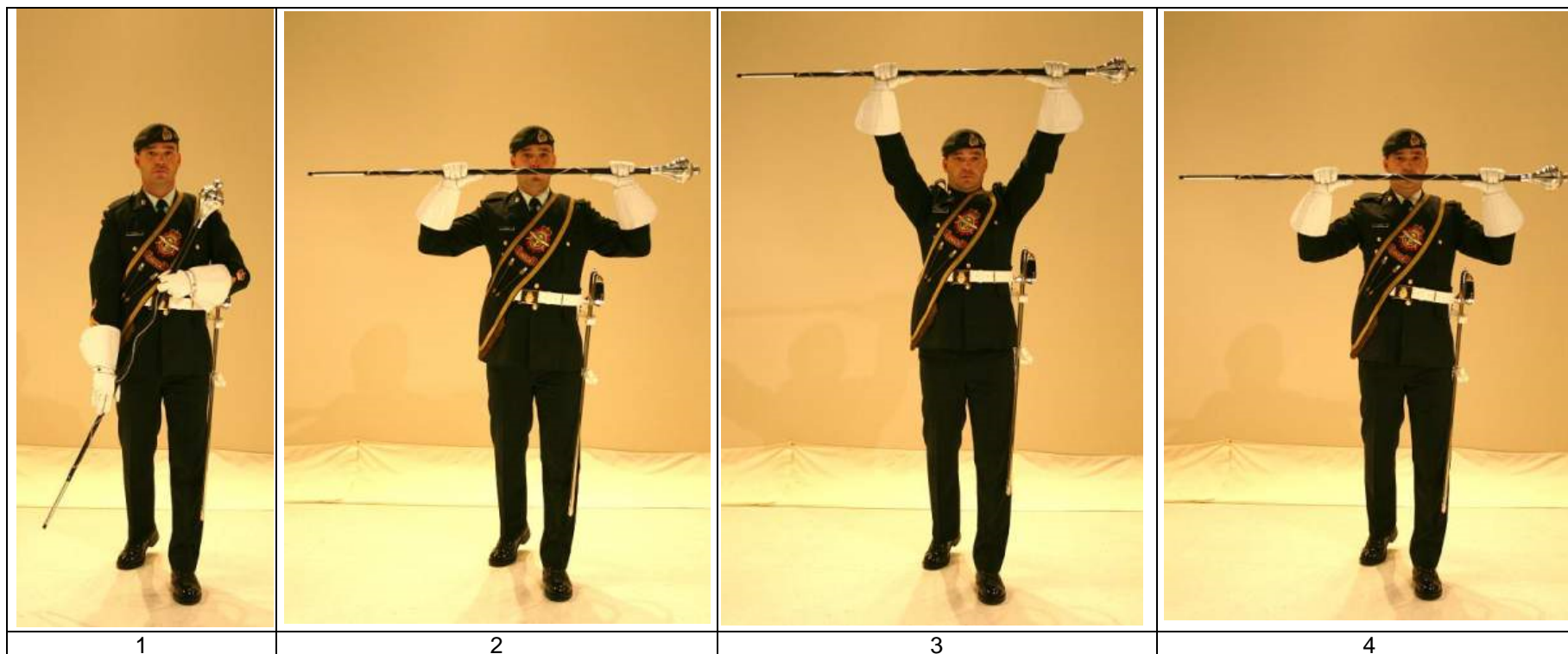

Figure 14-5- 17

Drum Major – Mark Time (A)

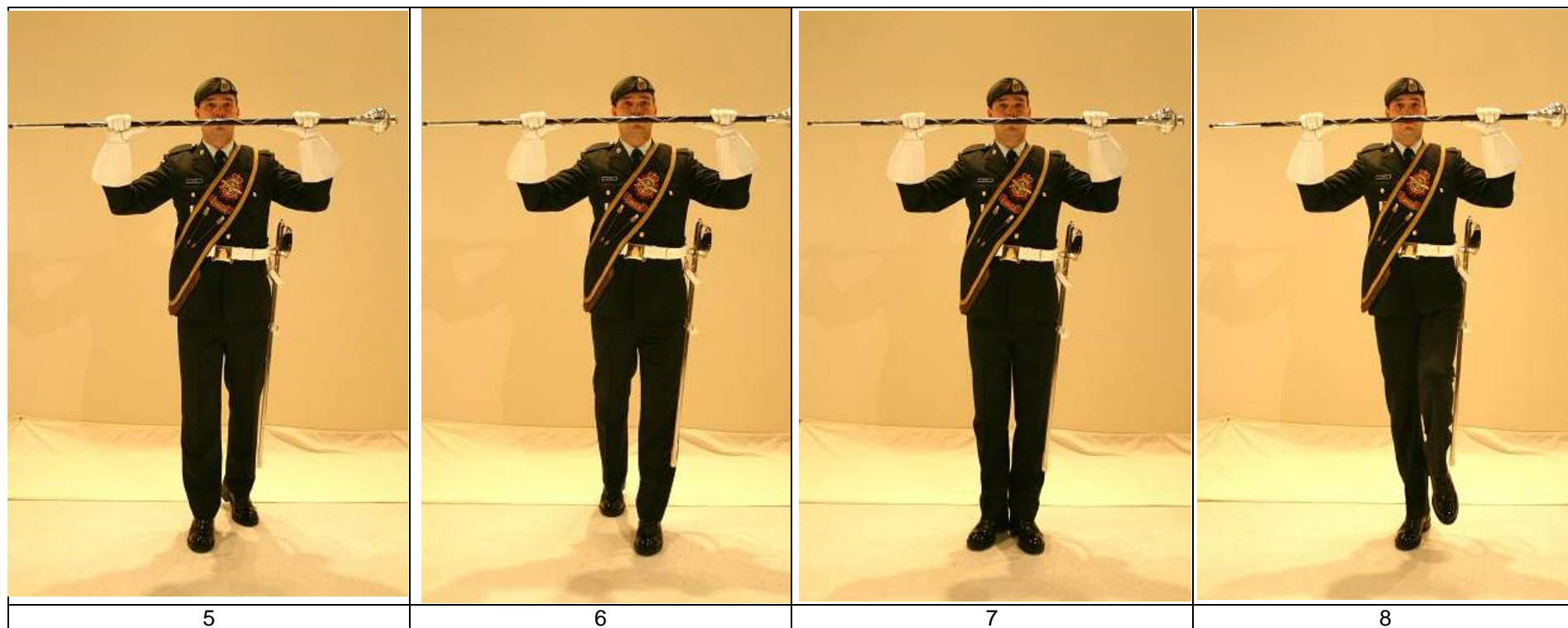

Figure 14-5-17 Drum Major – Mark Time (B)

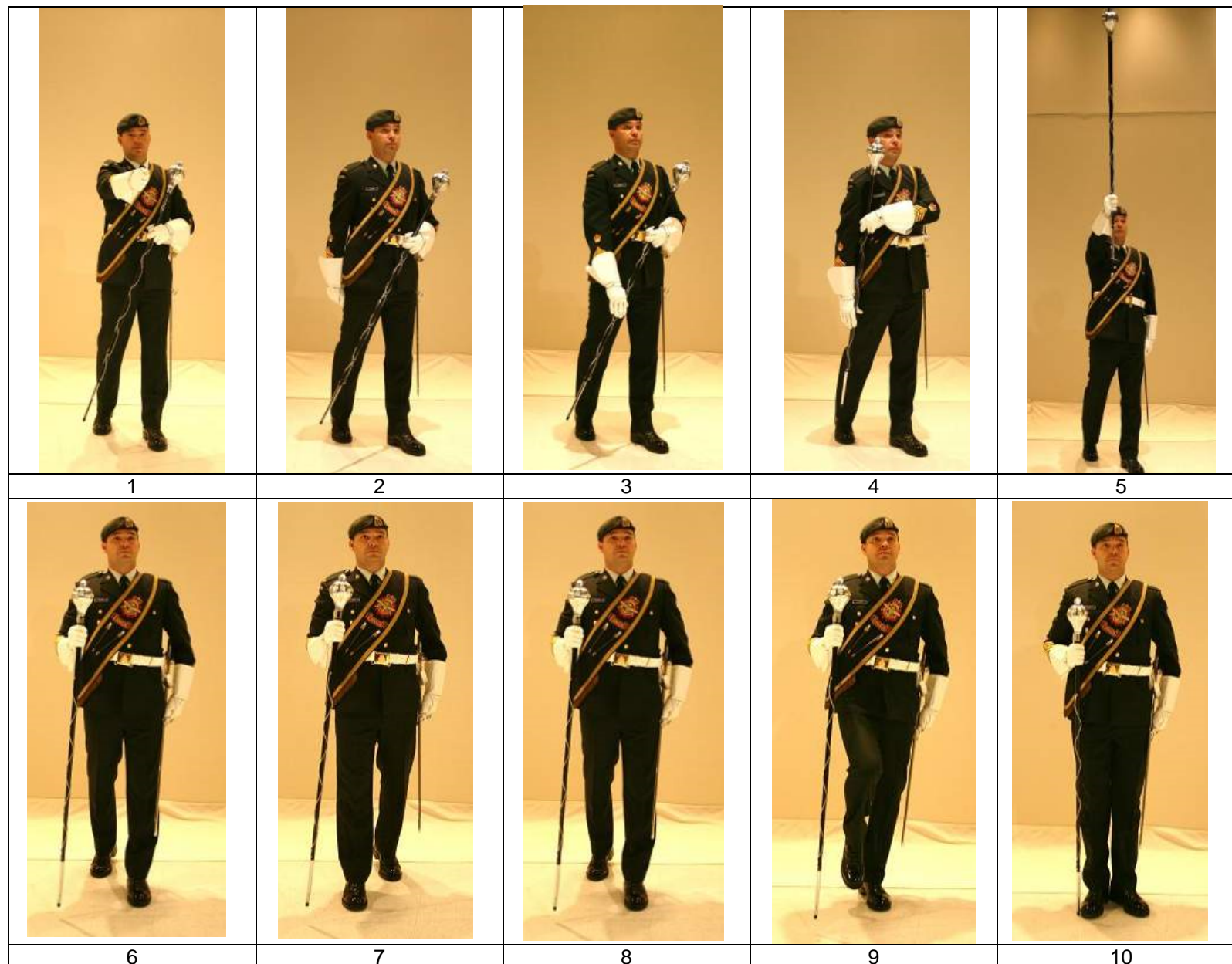

Figure 14-5- 18 Drum Major – Halting a Band

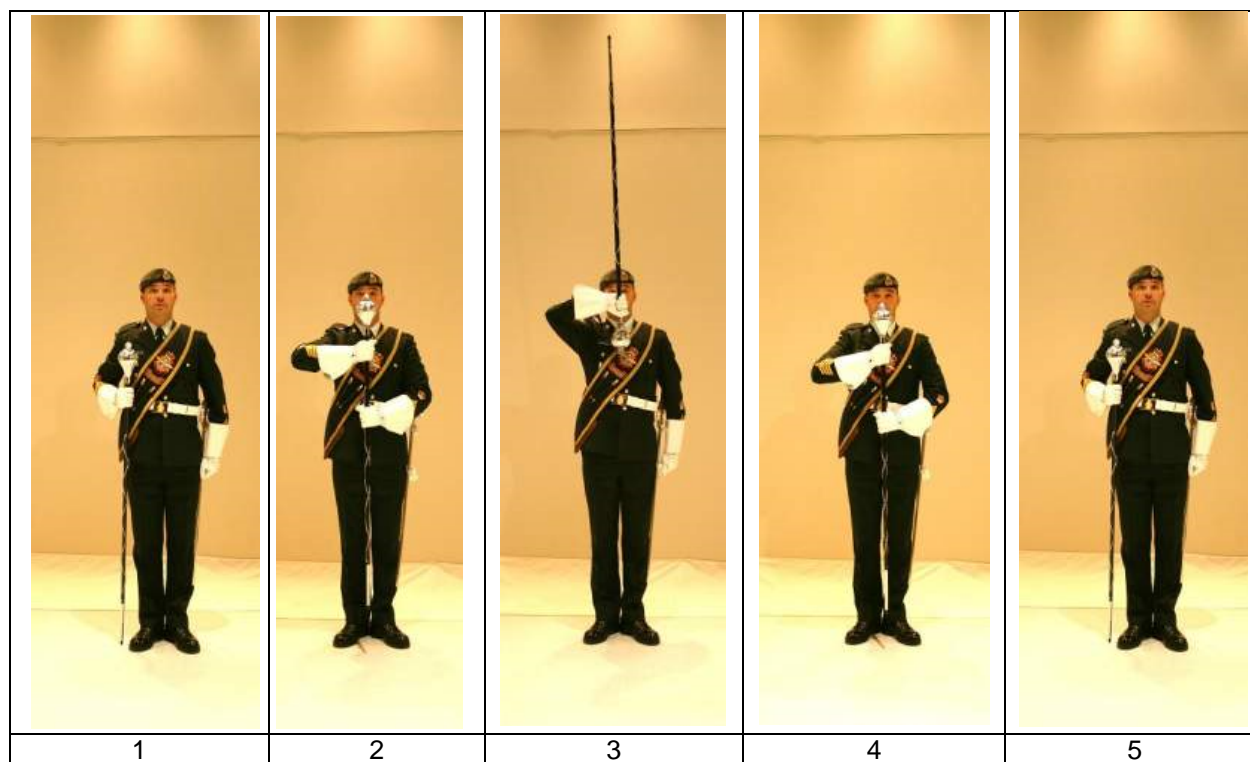

Figure 14-5- 19

Drum Major – Commence Playing at the Halt

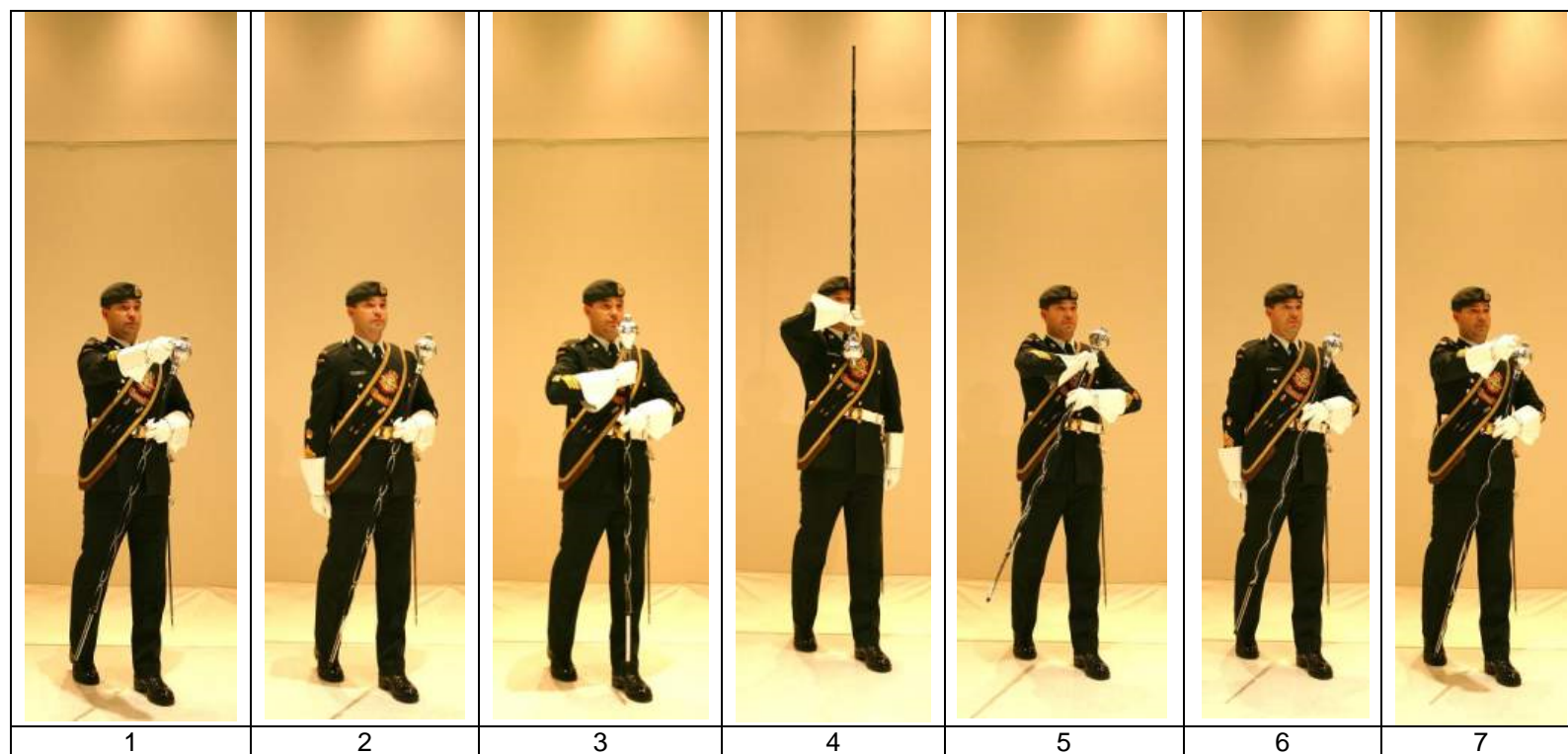

Figure 14-5- 20 Drum Major – Commence Playing on the March

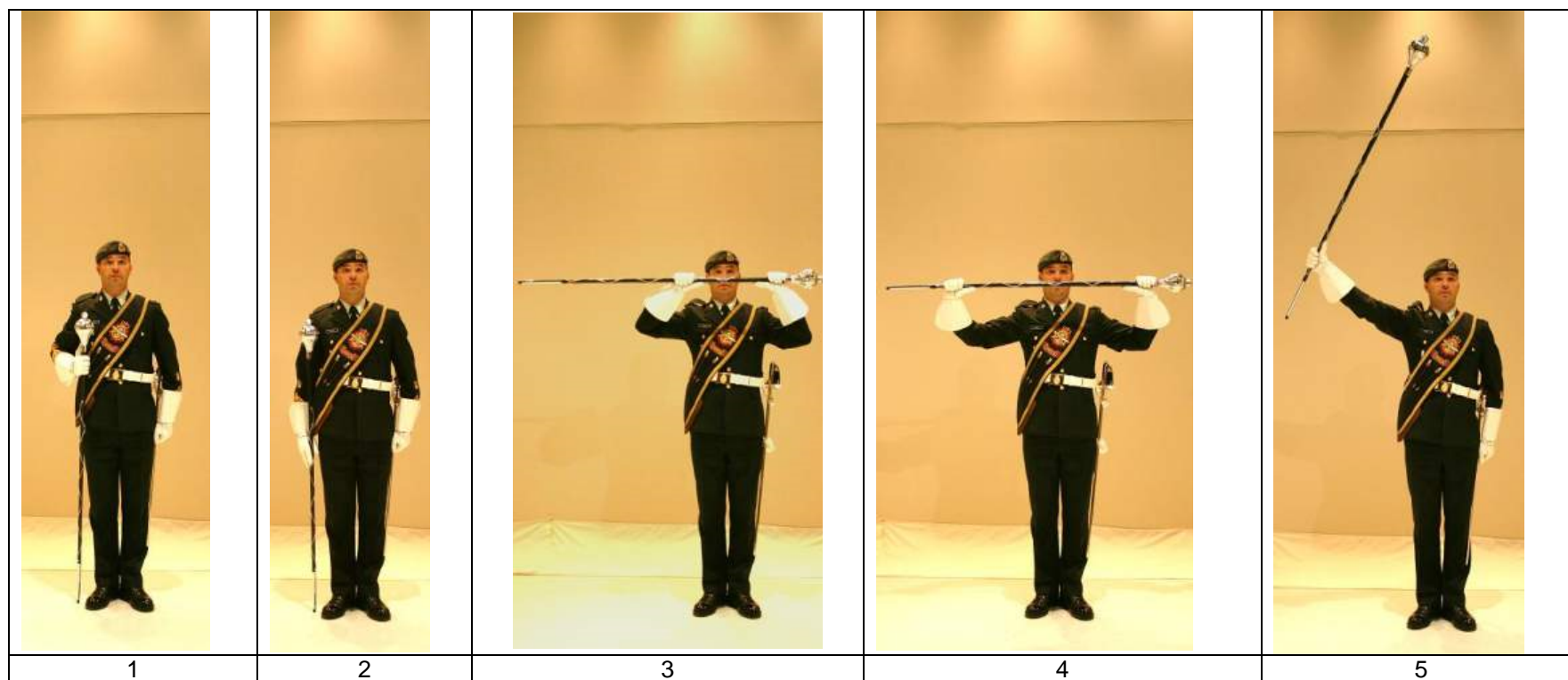

Figure 14-5- 21 Drum Major – Cease Playing at the Halt (A)



Figure 14-5-21 Drum Major – Cease Playing at the Halt (B)

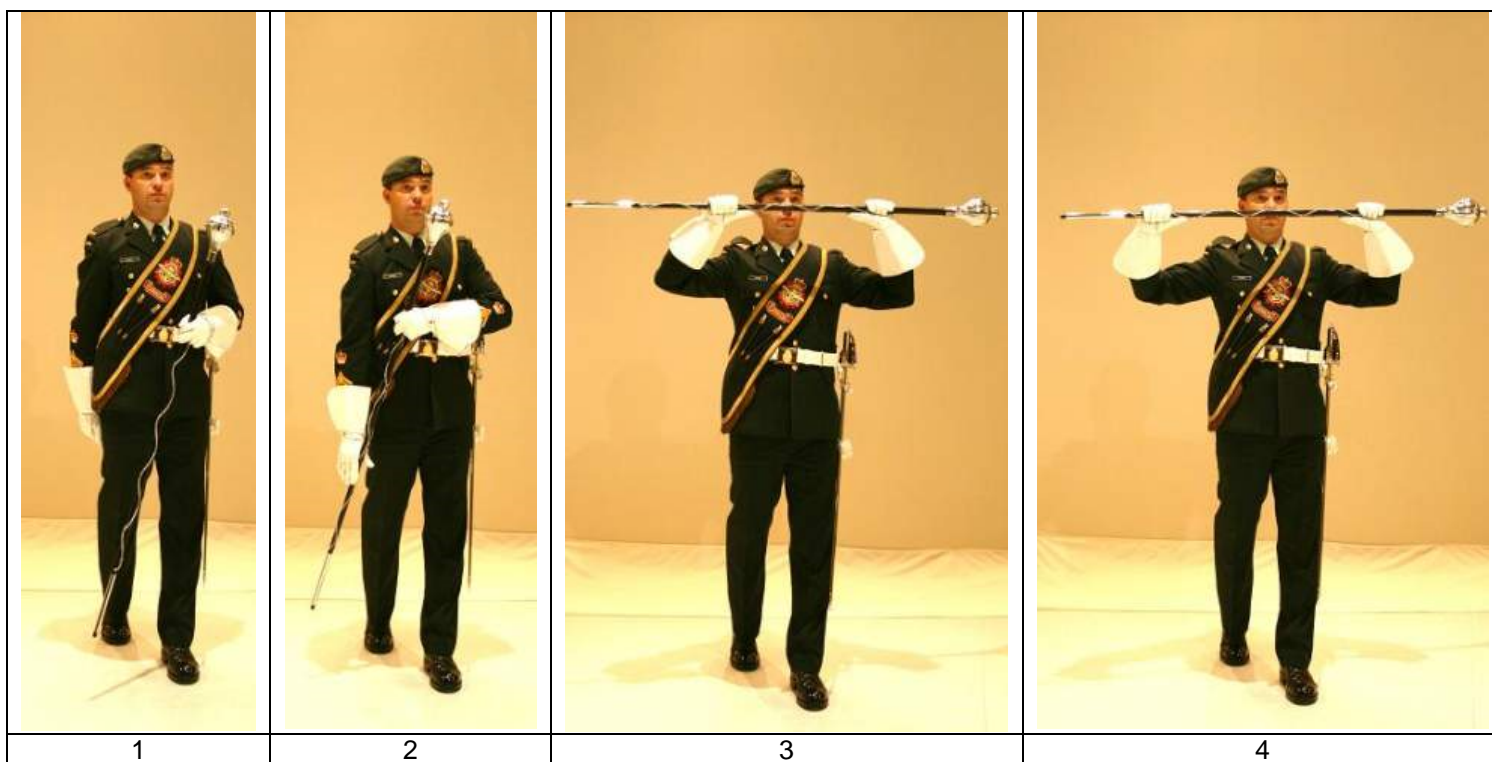

Figure 14-5- 22 Drum Major – Cease Playing on the March (A)

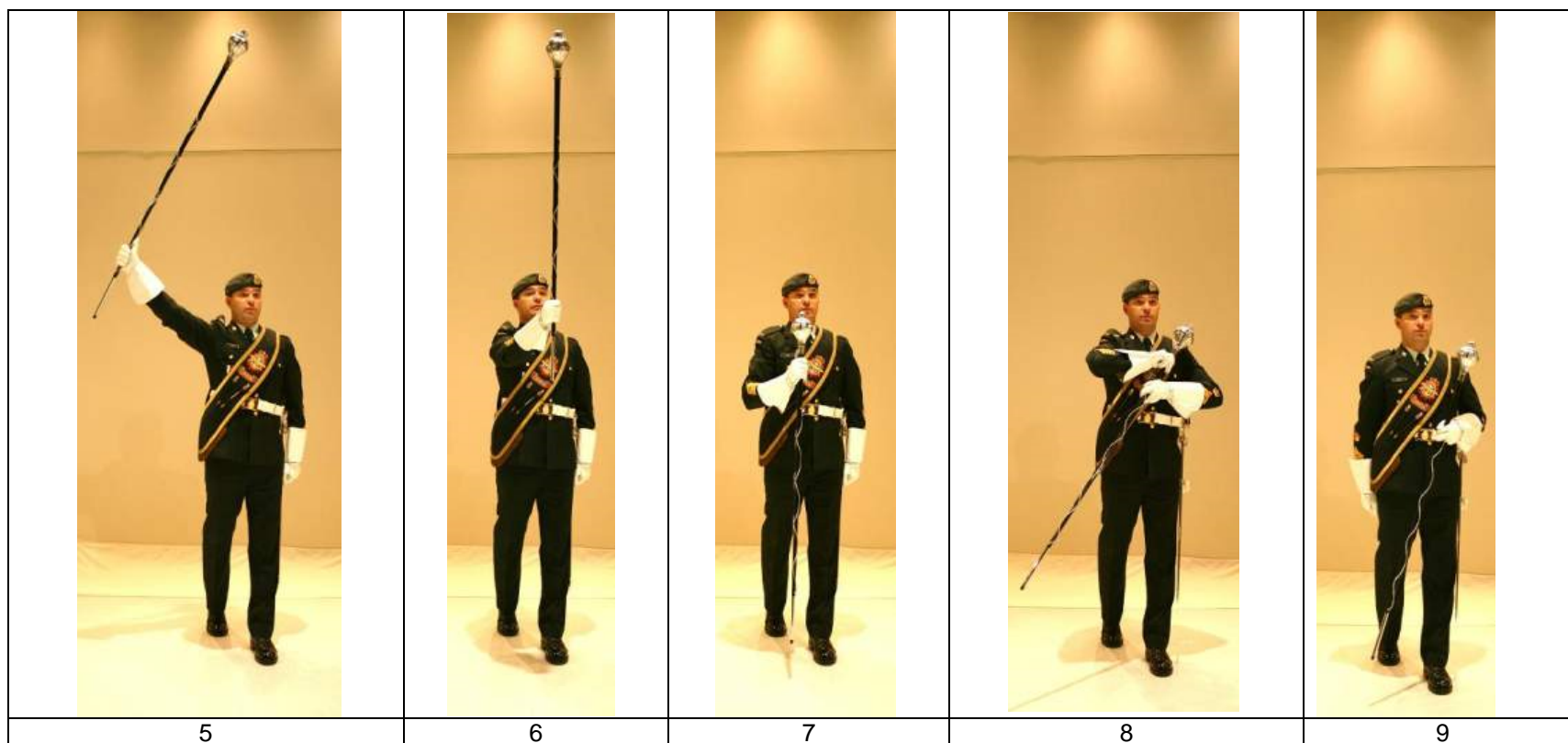

Figure 14-5-22 Drum Major – Cease Playing on the March (B)

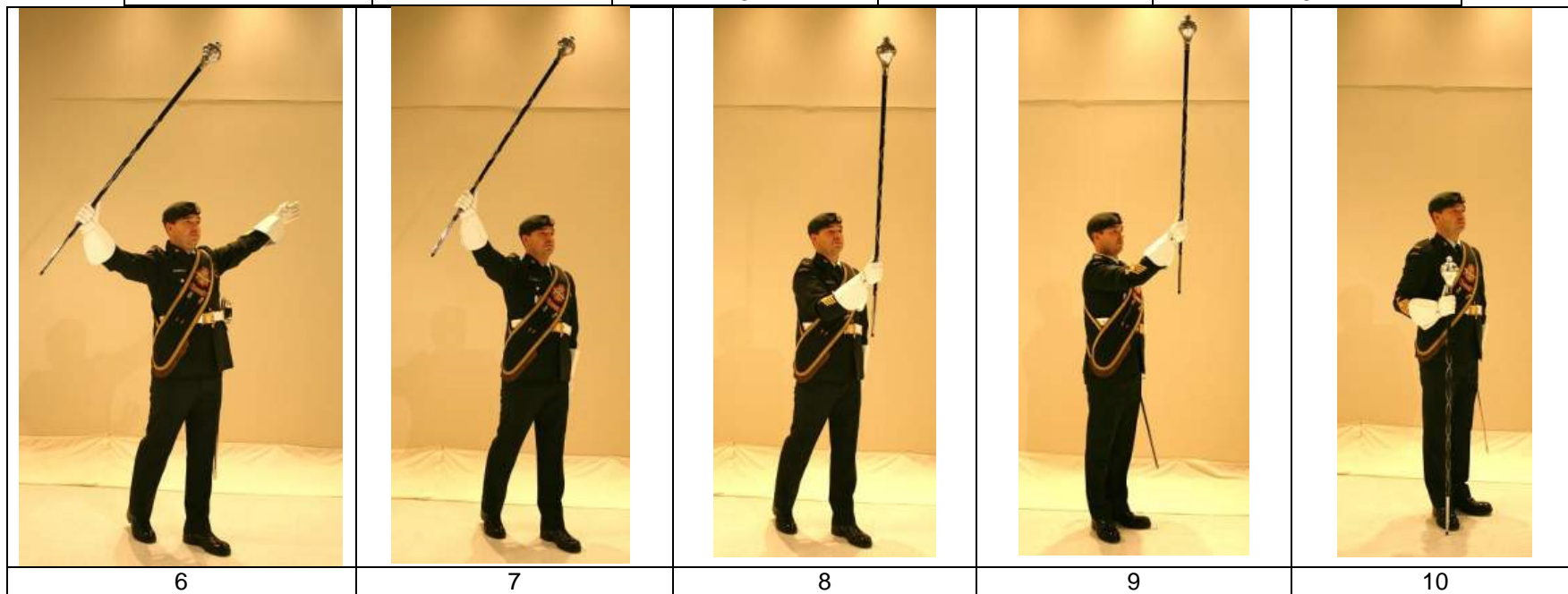
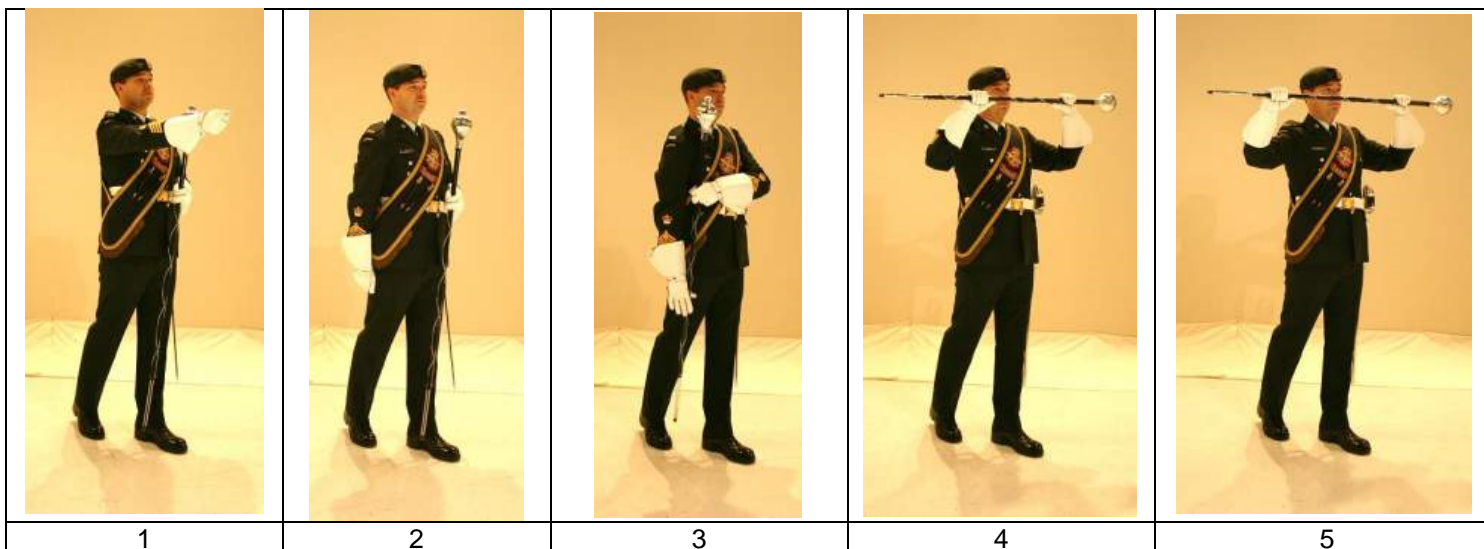

Figure 14-5- 23 Drum Major – Simultaneous Halt and Cease Playing

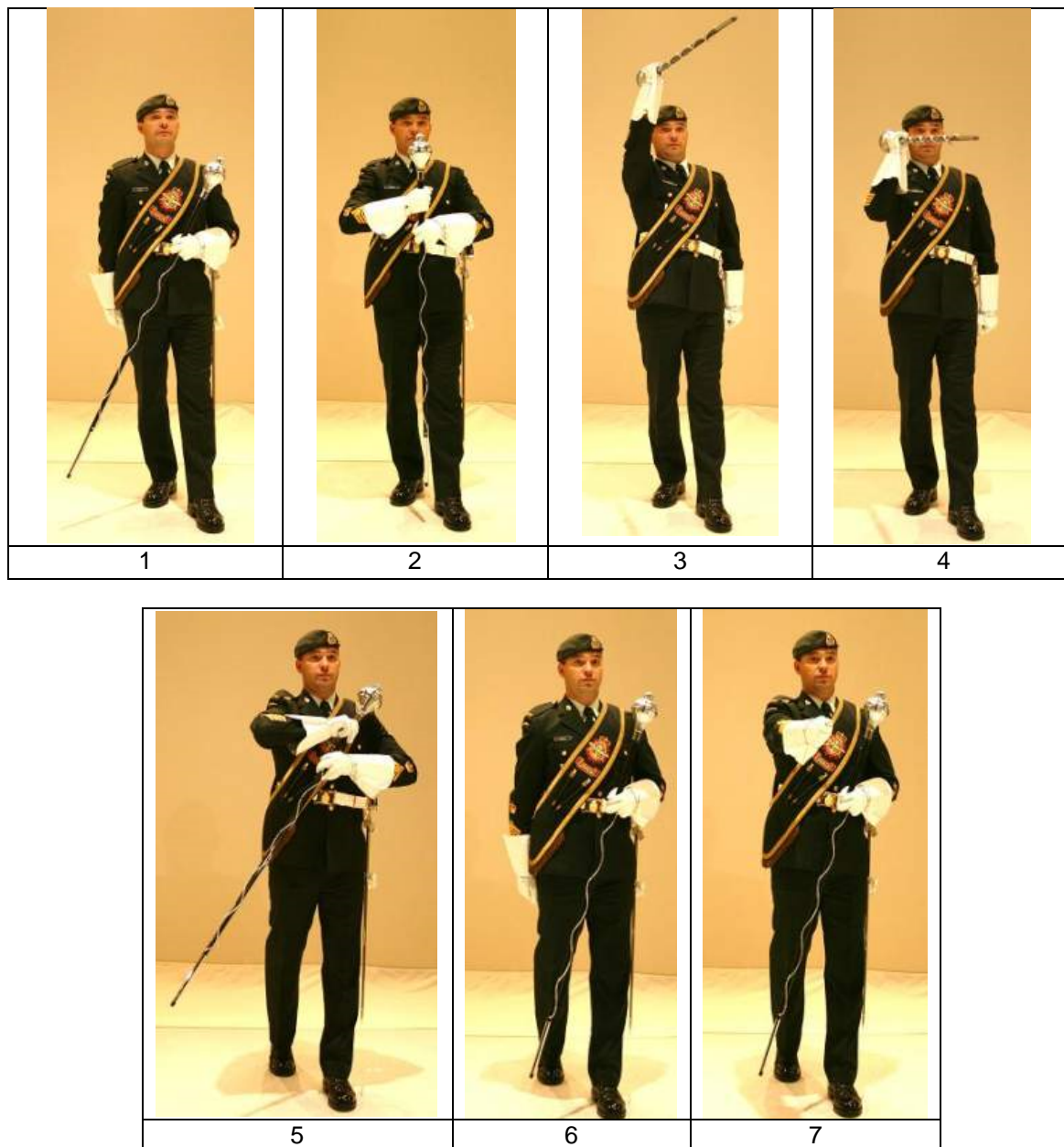

Figure 14-5- 24

Drum Major – Changing March Tempo

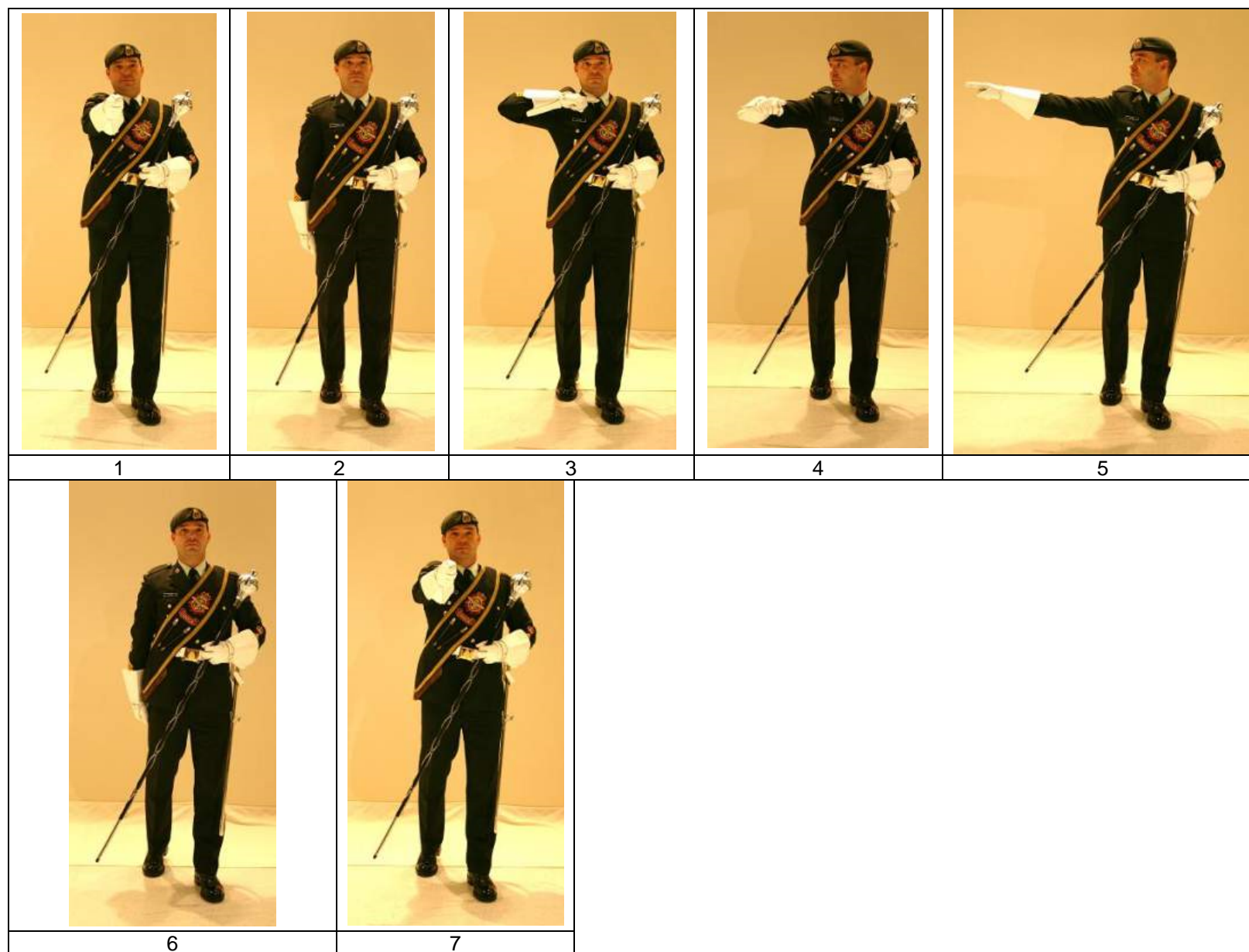

Figure 14-5- 25 Drum Major – Right Wheel

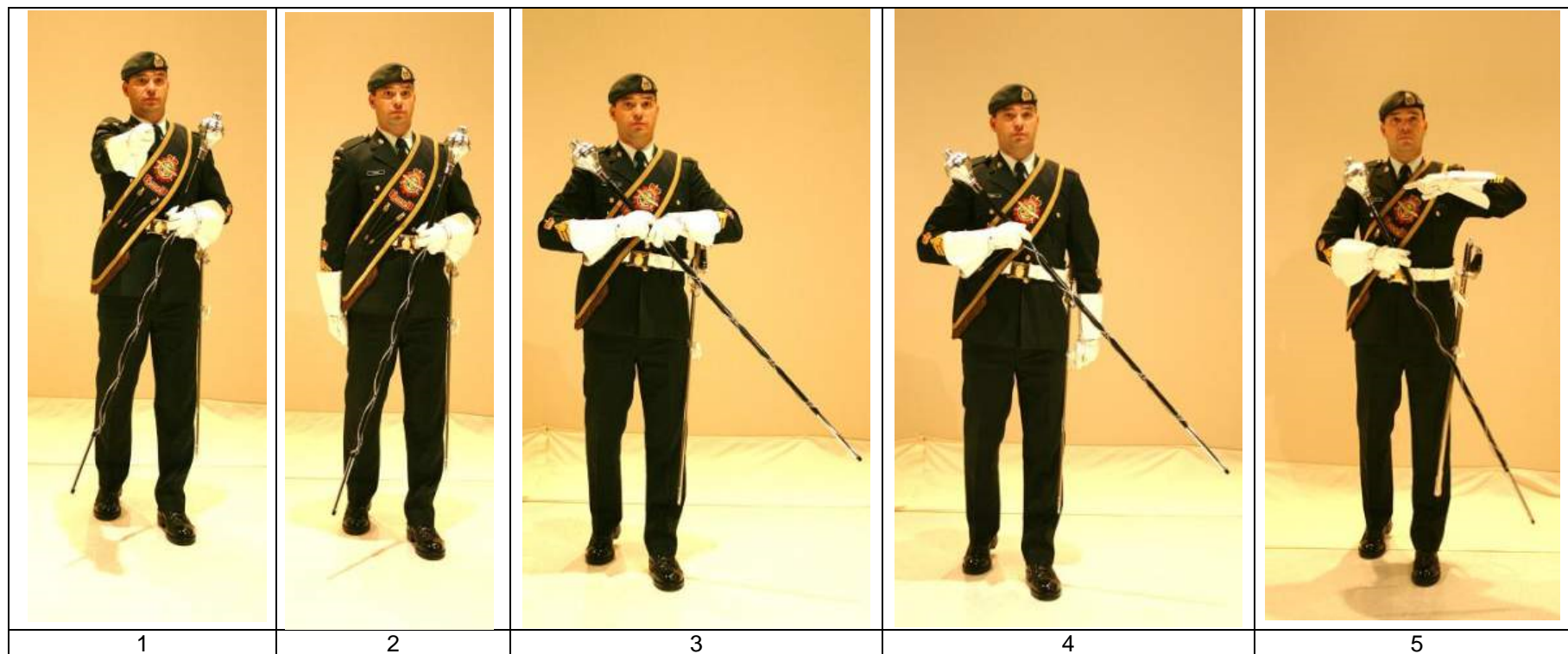

Figure 14-5- 26

Drum Major - Left Wheel (A)

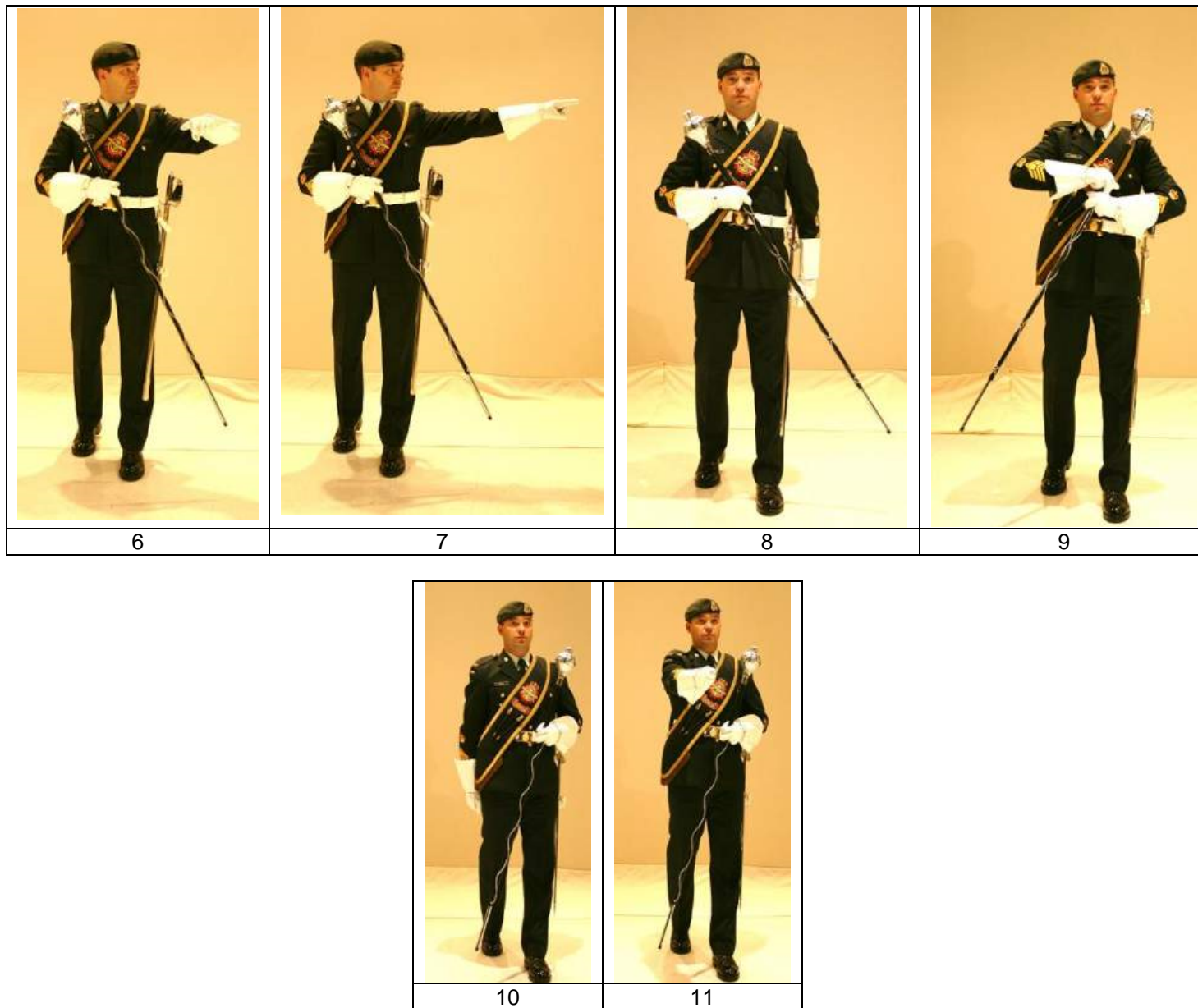

Figure 14-5-26

Drum Major – Left Wheel (B)

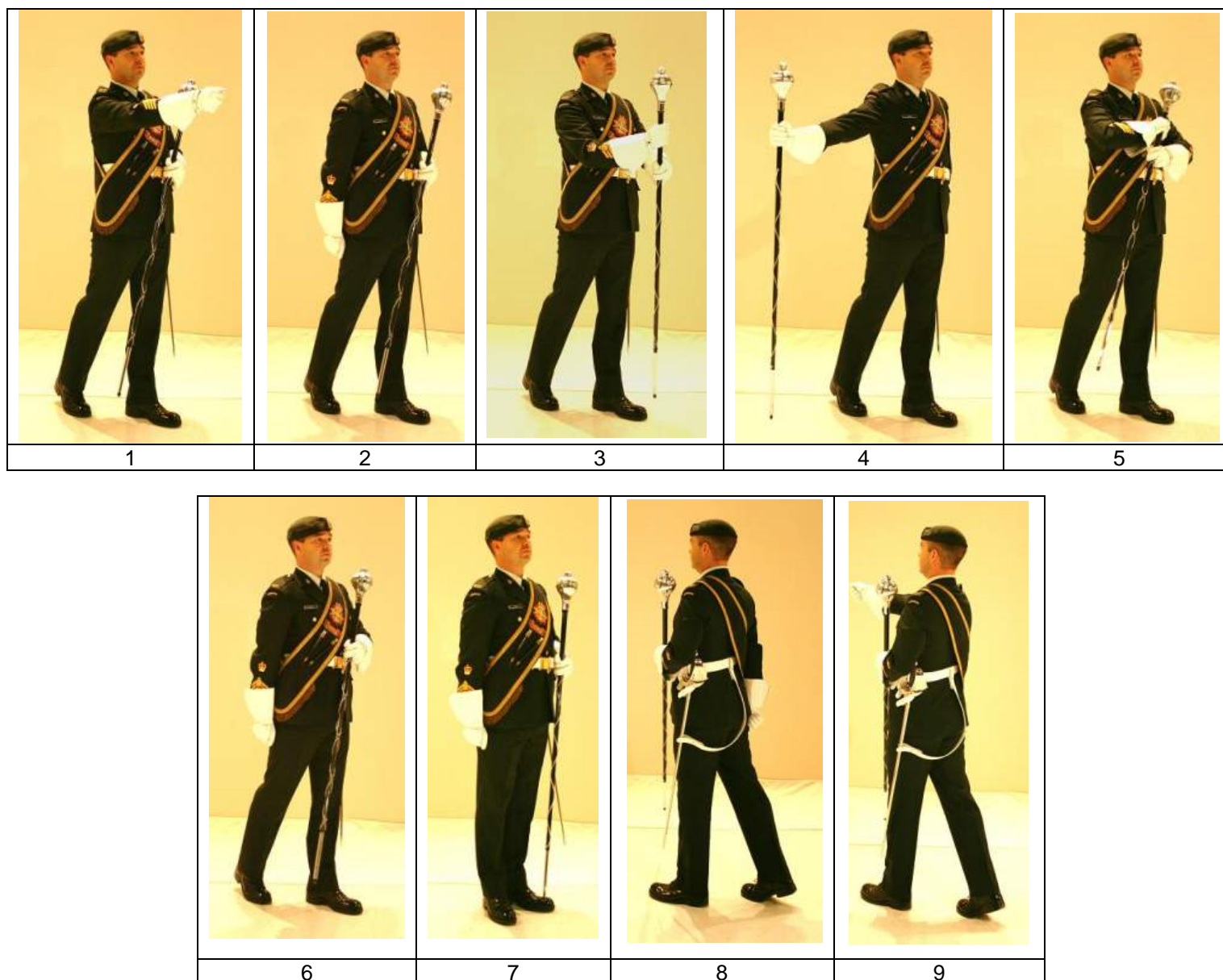

Figure 14-5- 27

Drum Major – Standard Counter-march



Figure 14-5- 28 Drum Major – Spiral Countermarch (A)



Figure 14-5-28 Drum Major – Spiral Countermarch (B)



Figure 14-5- 29 **Drum Major – Common Coordination Signal**



Figure 14-5- 30 Drum Major – Circling the Mace and Dipping the Mace

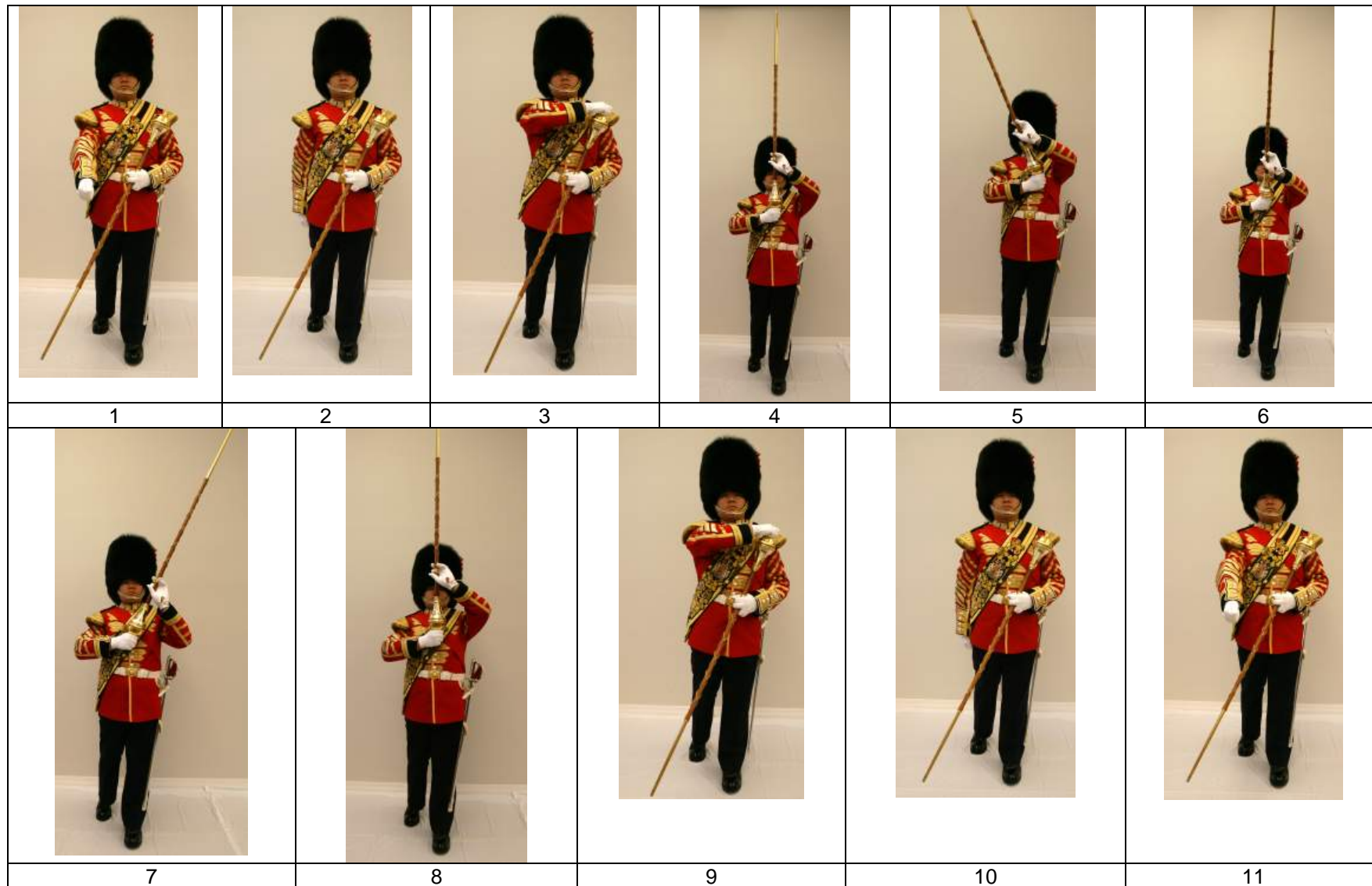

Figure 14-5- 31 Drum Major – Mark Time Signal for Massed Bands